



FABRICANT
FRANÇAIS
DE MOBILIER
DE BUREAU



Collection 2023 / 2024
eol-group.net

EOL

conçoit et fabrique
une offre de mobilier dédiée à l'aménagement
d'espaces de travail uniques où venir fait sens

Inspirée par l'esthétique du design français, notre offre de mobilier est fonctionnelle, créative et durable. Elle est disponible sur stock ou personnalisable à la demande



NOUS FONDONS NOTRE SAVOIR-FAIRE SUR UNE TRIPLE COMPÉTENCE

Création et fabrication française

Du design à la conception,
nous maîtrisons le travail du bois,
du métal et de la tapisserie

Conseil en aménagement

Nous vous aidons à répondre
aux enjeux des espaces de travail

Une organisation logistique structurée et globale

Nous stockons, livrons
et installons votre mobilier



+ 250
collaborateurs



2 sites
de production
en France



+ 7
+7 pays livrables
rapidement sur stock
(FR, BENELUX, UK, IRL et CH)



20 000 m²
de produits finis
stockés

Agir concrètement pour le développement durable

Depuis 2017, EOL a intégré les défis du changement climatique et le respect de notre écosystème au cœur de sa stratégie par la mise en œuvre de 30 actions éco-responsables.

Dans un souci de cohérence, EOL a intégré en 2022 les objectifs de développement durable fixés par l'ONU. Ces objectifs sont déclinés en plans d'actions pour l'ensemble des équipes et partenaires de EOL.

Suite à une analyse d'impact prenant en compte l'activité de EOL, 9 objectifs ont été retenus comme prioritaires à l'horizon 2025



Nos 9 axes de progrès pour le développement durable



BONNE SANTÉ ET BIEN-ÊTRE

- › Réduction du nombre/gravité d'accidents de travail
- › Utilisation d'équipements de protection individuelle
- › Diminution de la pénibilité (investissements machines usine de EU)
- › Pas d'utilisation de produits CMR ni de solvants
- › Conformité REACH (Règlement Européen par rapport aux produits chimiques)
- › Utilisation de mousses et tissus OEKO-TEX (label de qualité textile)
- › Mise en place du télétravail pour les fonctions de support



ÉNERGIE PROPRE ET D'UN COÛT ABORDABLE

- › Diminution de la consommation énergétique en gaz et électricité
- › Relamping LED dans nos ateliers
- › Engins électriques
- › Réinjection de l'air chaud aspiré en menuiserie
- › Investissements dans des machines plus performantes
- › Adaptation des process afin de les rendre moins énergivores
- › Baisse de la température des locaux
- › Mise en place de temporisateurs d'éclairage
- › Optimisation de la température du four de séchage



CONSOMMATION ET PRODUCTION RESPONSABLES

- › Diminution de la consommation de matières premières et optimisation des taux de chute (bois, métal, tissu)
- › Utilisation de matériaux recyclables et à base de produits recyclés
- › Recherche de matériaux alternatifs ayant un impact moindre sur l'environnement
- › Diminution des emballages et utilisation d'emballages recyclables
- › Multi-rotations des emballages primaires ou secondaires (palettes, cages métal, coins, cartons d'emballage des sièges,...)
- › Inter-modularité des composants



TRAVAIL DÉCENT ET CROISSANCE ÉCONOMIQUE

- › Diminution des accidents de travail
- › Recours aux ESAT/CAT
- › Emploi local
- › Emploi de travailleurs en situation de handicap



ÉGALITÉ ENTRE LES SEXES

- › Répartition hommes/femmes au sein des fonctions de support
- › Mise en place de grilles de salaire pour objectiver le rapport responsabilité/salaire



EAU PROPRE ET ASSAINISSEMENT

- › Baisse de la consommation d'eau (cabine de dégraissage)
- › Rejets en eau conformes à la réglementation
- › Traitement de surface doté de bassins à cascades inversées



MESURES RELATIVES À LA LUTTE CONTRE LES CHANGEMENTS CLIMATIQUES

- › Utilisation de transporteurs adhérents à la charte CO²
- › Taux de chargement optimisés
- › Diminution du nombre d'impression de catalogues imprimés. Transition vers une offre digitale



VIE TERRESTRE

- › Utilisation de bois certifiés PEFC (biodiversité et lutte contre la déforestation)
- › Absence de pollution (sol, eau, air) par notre respect de la législation en vigueur



PARTENARIAT POUR LA RÉALISATION DES OBJECTIFS

- › Dons aux associations
- › Recherche active de filières industrielles de composants issus du recyclage



Nos engagements

Notre stratégie, nos actions quotidiennes, nos comportements, nos produits et services sont guidés par des valeurs fortes qui soutiennent les finalités suivantes :

Favoriser le bien-être
des utilisateurs

Garantir la qualité
et la sécurité de nos produits

Placer l'innovation
au cœur de nos préoccupations

Avoir un impact positif
sur la société

NOTRE APPROCHE

UNE OFFRE POUR CHAQUE USAGE

Nous plaçons l'utilisateur au coeur de notre démarche de développement produit et aménagement

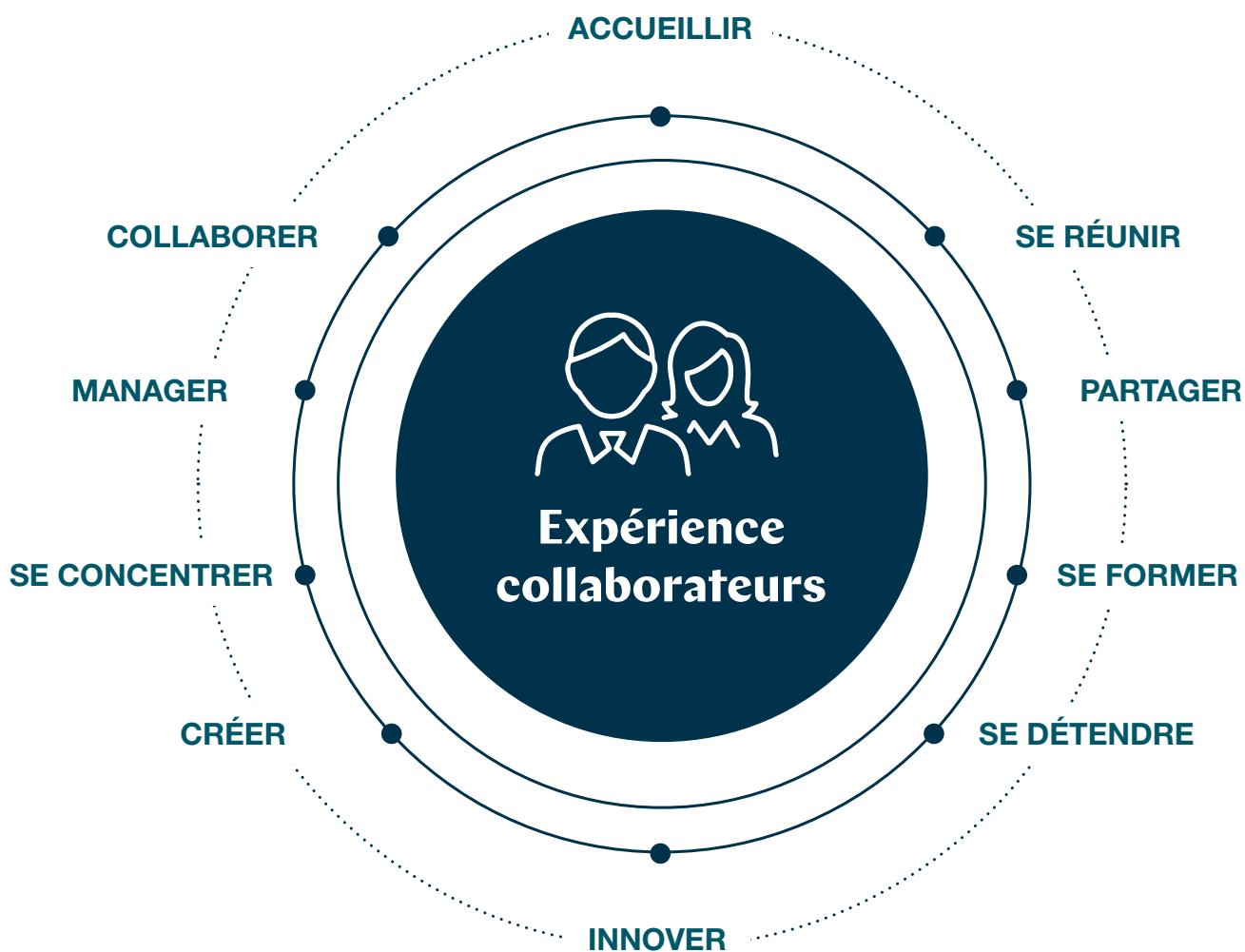

Nos services :

Des solutions globales pour des projets uniques

Plus que jamais, l'aménagement des espaces tertiaires est un outil de management et de performance des organisations. Au cœur des problématiques d'aménagement depuis plus de 30 ans, nous vous accompagnons dans la réalisation de votre projet.



ÉCOUTER

COMPRÉHENSION DES BESOINS

Définir le périmètre
de votre projet

Restituer vos enjeux
et contraintes

.....



ANALYSER

MATÉRIALISATION DU PROJET

Imaginer les solutions
qui correspondent à vos besoins
et à votre budget

.....



FABRIQUER

PRODUCTION FRANÇAISE

Maîtrise du travail du bois, du métal et de la
tapisserie (2 usines en Bourgogne et Normandie)

Fabrication de mobilier standard
ou sur mesure pour les projets à volume

.....

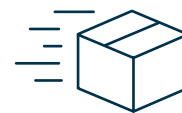

STOCKER

LIVRAISON RAPIDE

Une majorité de produits disponibles sur stock
dans les finitions les plus demandées

Suivi en temps réel de la disponibilité
des produits (EOL.net)

.....



INSPIRER

TENDANCES ET PROSPECTIVE

Écoute et analyse des tendances sociétales, des usages et des nouvelles technologies

Identité d'entreprise, univers de styles et ambiance de travail

.....



AMÉNAGER

IMMERSION ET ACCOMPAGNEMENT

Zoning, respect des flux et modes de travail

Visualisation et projection d'espaces en 2D et 3D pour décider et communiquer

.....



LIVRER ET INSTALLER

SERVICE LOGISTIQUE À LA CARTE

Livraison, dépose, et/ou montage du mobilier

12 plateformes de dégroupage, des équipes d'installateurs professionnels

.....



SUIVI ET QUALITÉ

ASSISTANCE ET SAV

Des produits certifiés & garantis

Suivi des installations et du parc mobilier une fois équipé

.....

Inspirations 2023-2024

Au plus près des tendances

Pour vous guider dans la création d'espaces de travail uniques, découvrez 8 styles décoratifs. Imaginés par notre studio design, ils mettent à l'honneur les matières et couleurs de notre nuancier général



MA

Minimal

Simple
Essentiel
Serein



DF

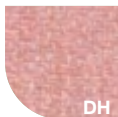

DH



MG

Green working

Naturel
Engagé
Vivant



RI



B2



B3

Nouveau classique

Tradition
Statutaire
Sobriété

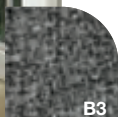

N5



M9



DI

Ocr'attitude

Terrestre
Nature
Chaleur



DJ



DZ

Focus sur le noir velours MK



Un toucher velours,
haute résistance



Un effet mat
qui sublime
les espaces



A retrouver sur
une sélection
de bureaux,
rangements et
tables de réunion



All in black

Caractère
Profondeur
Élégance

MK

LE

ZP



Néo rustique

Less but better
Noir & bois
Archétype

R3

B5

SG



Oxygène

Oasis retrouvée
Fraîcheur mentholée
Douceur

N6

DF

A9



Cocoon

Épuré
Apaisant
Organique

N5

ZC

BM

Travailler en mode hybride : les nouveaux usages

Nous sommes dans une nouvelle ère du travail

À l'heure où 4 grandes entreprises européennes sur 5* ont adopté une organisation hybride du travail, de nouveaux enjeux s'imposent quant à l'aménagement des espaces tertiaires.

LE TRAVAIL HYBRIDE C'EST QUOI ?

Le fait de mixer son temps de travail entre présentiel (sur site) et distanciel (chez soi ou dans un tiers lieu).



DANS MA BULLE

Intégrez des cabines acoustiques Chatbox en remplacement des salles de réunions classiques.

Elle optimisent l'espace, et le confort acoustique des collaborateurs en les isolant de l'open space.

Pour se concentrer, téléphoner ou échanger en toute confidentialité.

› Chatbox p. 184



NOUVEAU NOMADISME

Sièges autorégulés ou boîtier de connexion avec accès direct, des nouvelles options pour se connecter, s'installer sans perte de temps.

› Siège Eliott p. 116 - Oscar p. 220

› Nouvelles options de connectique p. 278



LES ENJEUX ?

› Des espaces plus collectifs :

plus que de simples espaces lounge, des espaces qui célèbrent le présentiel. Ils encouragent les activités collectives, créatives et l'esprit d'équipe

› Des espaces régénérants* :

au delà de la simple idée de bien être, il s'agit ici de privilégier le ressourcement physique et mental des salariés. Des espaces qui restaurent le niveau d'énergie des collaborateurs pour créer les conditions de la performance

› Des espaces flexibles :

ils s'adaptent selon l'usage ou la fréquentation des sites.

Une façon d'optimiser les m² sans empiéter sur le confort et le bien-être des collaborateurs.



CÉLÉBRER LE COLLECTIF

Créer un espace lounge pour se retrouver, échanger, partager ses idées en mode informel.

Un espace détente complémentaire avec une table Ping pour bouger, respirer entre 2 réunions.

Des espaces indispensables pour se régénérer et entretenir l'esprit d'équipe

› Margot p. 28

› Ping p. 178



ESPACE FLEXIBLE

Un espace agile dédié à une équipe projet. Ses éléments mobiles permettent d'adapter la pièce selon l'usage de l'équipe.

Il est réservable, dédié à l'équipe le temps du projet et sinon utilisable en mode Flex lorsqu'il n'est pas utilisé.

› Arial Mobile p. 168 - Martin p. 180 - Solange p. 116 - Camille p.136

Aménagez selon vos contraintes de temps

STOCK OU SUR MESURE ? DES SOLUTIONS SELON VOS BESOINS

Pour répondre à la diversité des projets d'aménagement, notre offre a été construite pour s'adapter à vos contraintes de style et de temps.

Nous vous offrons différentes possibilités de délais de livraison en fonction des articles et des nuances sélectionnées.

NUANCES EN STOCK

Une vaste sélection d'articles et de nuances sur stock

LIVRABLE EN
10 JOURS

NUANCES SUR DEMANDE

Une sélection d'articles et de nuances sur demande

LIVRABLE EN
4 à 6 SEMAINES

SUR MESURE

Nous personnalisons notre mobilier en fonction de vos projets (nuances, dimensions...)

LIVRABLE EN
6 à 8 semaines

COMPRENDRE NOS PICTOGRAMMES

Fabriqué en France
Fabriqué en France



Fabriqué en Europe
Fabriqué en Europe



Siège à monter soi-même



Siège pré-monté
(assise et dossier montés, lift, piétement et roulettes à monter) - Hors accoudoirs



Possibilité d'empiler des chaises



Possibilité d'empiler des chaises sur chariot

Un catalogue papier et des supports digitaux pour vous faciliter la vie

UN PARCOURS DE DÉCOUVERTE ON OU OFF LINE

Suivez le fil de vos inspirations à travers le catalogue. Lorsque vous souhaitez en savoir plus, scannez le QR code à disposition dans les pages produit.

Il vous donne accès à des informations détaillées : banque d'images, fiches techniques, finitions...

- 1 -

Choisissez

les produits qui vous intéressent dans le catalogue



- 2 -

Scannez le QR Code

TOUTES LES RESSOURCES ON LINE



- 3 -

Consultez

les fiches techniques et accédez à des informations complémentaires sur le site



Nuancier tissus

Cat. A, B, C, D disponibles sur délai.
L'ensemble des coloris est présenté en page 284



Renvoi vers les pages « connective »



Surface anti-bactérienne garantie pour tous les plateaux en mélamine excepté en décor MK Noir velours



Pourcentage issu de matière recyclée



Mobilier conforme aux personnes à mobilité réduite (PMR)

Sommaire

Espaces lounge & accueil 18

Assises modulaires	22
Chaufeuses et canapés	28
Tables basses	40
Banques d'accueil	42
Poutres	54

Espaces de travail 56

Bureaux direction	58
Bureaux collaborateurs & Séparations	80
Home office	82
Pourquoi un poste assis debout ?	84
Bureaux assis-debout	86
Bureaux	96
Séparations	116
Rangements	124
Rangements de proximité	126
Tower & caissons	128
Meubles casiers	136
Armoires	140
Classeurs	149
Rayonnages	150
Vestiaires	152

Espaces réunion & collectivités 154

Tables de réunion	158
Tableau mobile	180
Cabines acoustiques	184
Tables multiusage	188
Tables de restauration	198

Assises 204

Sièges de travail 206

Comment bien régler son siège de travail ? 208

Sièges direction 210

Sièges ergonomiques 214

Sièges opératifs 222

Sièges spécifiques 224

Chaises 228

Chaises visiteurs 230

Chaises multiusage 236

Chaises restauration 250

Accessoires & électrification 262

Accessoires 264

Luminaires 266

Végétaux décoratifs 268

Corbeilles de tri sélectif 270

Portemanteaux 272

Accessoires de réunion 273

Accessoires de bureau 273

Bras supports écrans 274

Supports multimedia 277

Électrification 278

Connectique 278

Gestion des fluides & voiles de fond 279

Nuancier 282





Espaces Lounge & Accueil





Lounge & accueil



Zélie

LOUNGE

RÉUNION

BRAINSTORMING

Page 22 >

.....



Margot

LOUNGE

RÉUNION

Page 28 >

.....



Bip

LOUNGE

Page 34 >

.....



Tables basses

ACCUEIL

LOUNGE

Page 40 >

.....

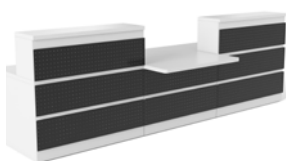

Guest

ACCUEIL

Page 42 >

.....



Greta

ACCUEIL

Page 48 >

.....



Galway

LOUNGE

Page 38 ›

.....



Chest

LOUNGE

Page 39 ›

.....



Évasion

ACCUEIL

Page 54 ›

.....



Rosalie

ACCUEIL

Page 55 ›

.....



Sosi

ACCUEIL

Page 55 ›

.....



Zélie

JOUER AVEC LES FORMES ET LES COULEURS

Avec ses formes géométriques, ZÉLIE signe d'un trait contemporain les espaces de travail.

Fabriqué
en France





Modules d'angle, carrés ou rectangulaires, mobiles ou fixes, les multiples possibilités de ZÉLIE rendent l'espace aussi unique que confortable.





Dynamique & modulaire



Reconfigurable

Assise 1, 2 ou 3 places, avec ou sans dossier

Fixe ou mobile

Pouf et assises

Tablette écrivain

Elle se déplace facilement selon les besoins

Connectée

Prises directement accessibles via les modules de liaison

Zooms



Module de liaison

Avec connectique intégrée
1 PC + 2 USB-A



Assise mobile

2 roues arrière



Système de liaison

Rétractable



Composer ZÉLIE



Exemples de configurations



Se réunir

Avec une tablette écriteire, elle ajoute une surface de travail et se déplace à volonté



Brainstormer

En version mobile, ZÉLIE apporte de l'agilité aux salles de brainstorming



Synoptique

Assises sans dossier

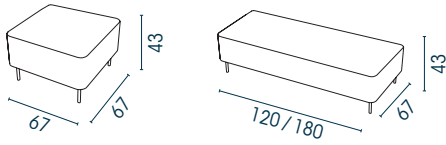

Modules de liaison

Avec ou sans connectique

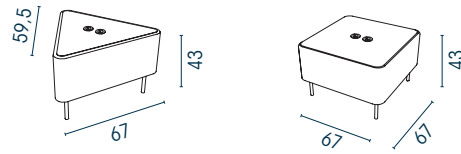

Assises avec dossier

Fixe

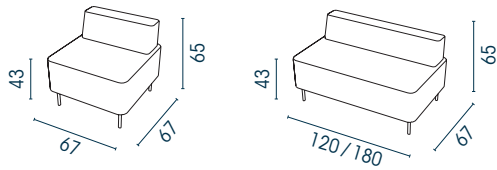

Mobile

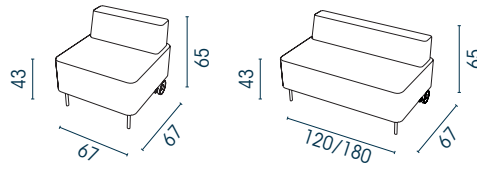

Poufs

Fixe ou mobile

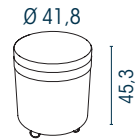

Tables basses

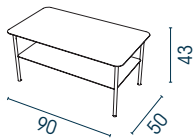
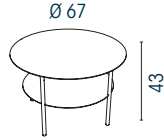

Tablettes écrites

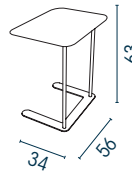
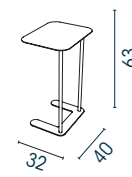

Nuancier

Tissu

Assise et dossier



Cat. A
BONDAÏ



Cat. B
STEP
STEP MÉLANGE
CHILI



Cat. C
SECRET



Cat. D
FENICE
VOGUE

Métal

Piètement, tables



SO



SG



ZO
Structuré



SC



Accueillir

Forme S

Jouer avec le module d'angle !

Îlot central

Peu importe la forme, le module d'angle permet de rester connecté pendant l'attente

TARIF P. 6

Détails et disponibilités

TOUTES LES RESSOURCES
EN LIGNE





Margot

L'ART DE VIVRE À LA FRANÇAISE

MARGOT habille avec raffinement les espaces. Son élégance tient à l'équilibre audacieux de ses formes, au contraste créé par l'association d'une assise moelleuse avec un piètement aux lignes épurées.

Fabriqué
en France





Un style distinctif qui n'oublie pas d'être fonctionnel. Les assises disposent d'un accès direct à la connectique. Multiusage, elles s'adaptent autant aux espaces d'accueil, qu'aux zones informelles des espaces de travail.



< **Électrification
des 2 côtés
de l'assise**
 À droite et
à gauche



< **Piédement**
 Bois ou métal



< **Tablette
pivotante**
 Plateau mélamine
ou linoléum



Moderne & distinctive



Multiusage

Haut ou bas dossier, avec ou sans cloison, les assises permettent de varier les usages : fauteuil isolé, zone d'attente, de détente ou de réunion informelle (box de 2 ou 4 personnes)



Connectée

Assises et plateaux équipés de prises avec connexion directe (PC + USB-A)



Détail des finitions

Un passepoil souligne les courbes de l'assise





Composer MARGOT

Exemples de configurations



Se détendre

En version bas dossier

Idéale pour les coins cosy dans un bureau de direction, un espace détente ou d'accueil



Accueillir

Jouer avec les hauteurs

Des versions hautes pour délimiter les espaces ouverts ou les zones de circulation



Synoptique

Fauteuils et Canapés

Bas dossier
Avec ou sans connectique

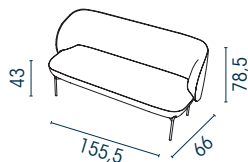
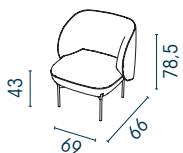

Haut dossier
Avec ou sans connectique

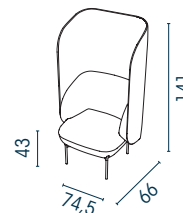
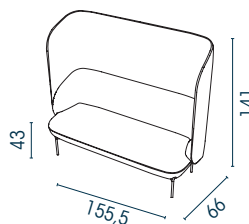

Cloisons avec table

Avec connectique

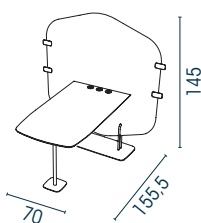
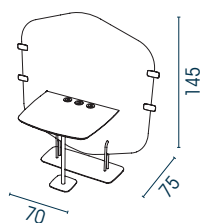

Méridienne

Avec ou sans connectique

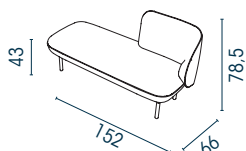

Tables basses

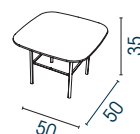
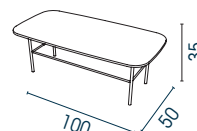

Pouf

Ø 42



Accessoires

Tablette
écrivain

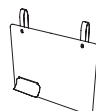

Tête ou
cousin tissu



Tablette
pivotante



Kit
d'électrification



Nuancier

Tissu

Assise et dossier



Cat. B
STEP
STEP MÉLANGE
CHILI



Cat. C
SECRET



Cat. D
FENICE
VOGUE

Métal

Piètement, tables



SO



SG



ZO

Structuré



SC

Métal / Bois

Piètement des assises



ZOMS



SUMS



ZPMS

Linoléum

Plateaux ép. 20,6mm



LU



Se concentrer

En version haut dossier

Un fauteuil 1 place pour s'isoler
ou travailler



Se réunir

À 2 ou 4 personnes

Au sein d'un espace ouvert

TARIF P. 7

Détails et disponibilités

TOUTES LES RESSOURCES
EN LIGNE





Bip

GÉNÉROSITÉ DES FORMES POUR UN CONFORT OPTIMAL

Modernes et généreuses, les assises BIP offrent une assise enveloppante et confortable.





Fixe ou pivotante, avec un large choix de piétements, BIP s'adapte autant aux espaces d'accueil, de détente que de réunion.



Nuancier spécifique

Tissu EVO Cat. A



TS

Noir

TH

Gris souris

Similicuir VALENCIA Cat. C



F1

Gris perle

F2

Gris

F3

Noir

F4

Bleu marine

F5

Jaune maïs

F6

Vert Olive

F7

Terra cotta

F8

Grenat

F9

Beige

Tissu STEP Cat. B



A1

Bambou

A2

Beige

A3

Bleu marine

A4

Bleu pétrole

A5

Jaune moutarde

A6

Noir

A9

Vert anglais

E4

Vert D'eau

E5

Gris clair

E6

Tomette



Généreuse & confortable



Une assise pour chaque usage

Piètement conférence ou 4 pieds, pivotant ou réglable en hauteur

Une assise pour chaque espace

accueil, détente, réunion

Lignes arrondies et enveloppantes

Surpiqûre contrastée pour un style unique

Mobile

Roulettes sols durs ou souples

Tissu SYNERGY Cat. C



Q1
Beige clair chiné



Q2
Marron chiné



Q3
Gris smoke chiné



Q4
Gris anthracite chiné



Q6
Corail chiné



Q7
Saumon chiné



G1
Bleu foncé chiné



Surpiqûres blanches pour les coloris noirs (TS, A6, F3, YB).
Surpiqûres noires pour tous les autres coloris.

Cuir Cat. E



G2
Chocolat chiné



G3
Céladon foncé



G4
Vert d'eau



YB
Noir



Y1
Taupe

TARIF P. 10
Détails et disponibilités
TOUTES LES RESSOURCES
EN LIGNE





GALWAY



Un classique intemporel
aux lignes épurées

Confort ferme

Version Non Feu
(mousse interne
avec tissu mirage)

Nuancier spécifique

Similicuir inca Cat. A



EG
Noir



EH
Gris clair



EI
Sable



EJ
Beige



EK
Vert foncé



EL
Bleu marine



EM
Rouge bordeaux



EN
Citrouille

Tissu non feu mirage Cat. B



WA
Noir



WB
Gris foncé



WD
Gris clair



WE
Beige



WF
Vert clair



WG
Bleu navy

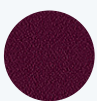

WH
Prune



WI
Orange



YB
Noir

CUIR Cat. E



TARIF P. 11

Détails et disponibilités

TOUTES LES RESSOURCES
EN LIGNE





CHEST



Des lignes douces et arrondies
pour un confort enveloppant

Equipé de 4 patins de réglage
pour ajuster la planéité au sol

Nuancier spécifique

Tisu Bondai Cat. A



KZ
Rouge



KE
Noir



K2
Bleu marine



KD
Gris nuage



KA
Gris orage

Simili cuir Cat. B



YA
Noir



TARIF P. 11
Détails et disponibilités
**TOUTES LES RESSOURCES
EN LIGNE**





Tables Basses

TROUVEZ LA BONNE TABLE BASSE

Une offre large et variée qui s'adapte à une multitude d'espaces : du style classique, minimaliste au plus contemporain. En bois, métal ou linoléum, pour travailler ou simplement prendre un café, choisissez votre version !

Fabriqué
en France



Sauf BIP



Sauf ZELIE



Surface
antibactérienne
(sauf Zélie)





MARGOT

43%



H. 35 x L. 100 x P. 50 cm

ZÉLIE

55%



H. 43 x L. 90 x P. 50 cm

ÉVASION

19%



H. 48 Ø 60 cm



H. 35 x L. 50 x D. 50 cm



H. 43 Ø 67 cm



H. 63 x L. 40 x P. 32 cm



H. 63 x L. 56 x P. 34 cm

SUSHI

33%



H. 32 x L. 60 x D. 60 cm

STAR

34%



H. 45 x L. 60 x D. 60 cm

PURE

23%



H. 43 x L. 76 x P. 59 cm



H. 32 x L. 110 x P. 70 cm



H. 45 Ø 75 cm

TARIF P. 12
Détails et disponibilités
TOUTES LES RESSOURCES
EN LIGNE





Guest

PERSONNALISEZ VOTRE ACCUEIL

GUEST est une banque d'accueil ultra personnalisable.

Fabriqué
en France



Surface
antibactérienne





Ses différents modules, son large choix de finitions et ses 4 décors de façades, permettent à GUEST de créer des espaces d'accueil singuliers.



Électrification



◀ **Obturbateurs de série**
(sauf modules PMR)



◀ **Avec ou sans échancrure**
(Intégration d'écrans jusqu'à 22 pouces)



◀ **Goulotte métallique**
pour passage de câbles (option)



Modulaire & personnalisable

Habillages

Mélanime ou métal
(4 décors au choix)



Mélanime

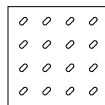

Biais

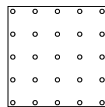

Pois

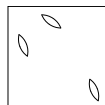

Feuilles

Éléments décoratifs



Surtablette
neutre



Sur-tablette
avec message
+ Option Kit Led
blanc ou couleur

Décorative

Une base de structure et piétement en mélanime blanche, qui accueillent des éléments décoratifs au choix

Une configuration pour chaque usage

4 modules au choix à assembler selon ses besoins

Côté utilisateur optimisé

Pieds intermédiaires adaptés pour un meilleur confort des jambes





Composer GUEST

Exemples de configurations

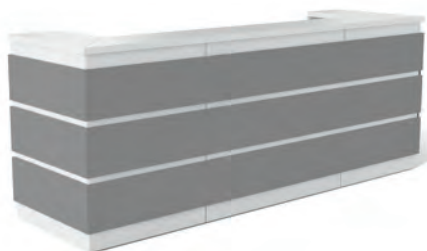

Banque fermée

2 Modules d'angle droite et gauche, ajoutés à un module haut, offrent un aspect confidentiel à la banque d'accueil. Le plus : montrer un espace toujours rangé



Banque ouverte

Intégrer un module PMR en extrémité ou au centre de la banque permet un accueil assis ou debout



Synoptique

Module bas

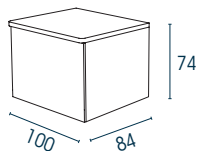

Modules haut

Avec ou sans échancrure (L.120 et 160)

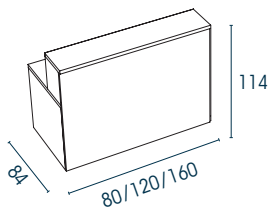

Moduels d'angle

90° Droite ou Gauche

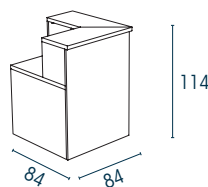

Modules PMR*

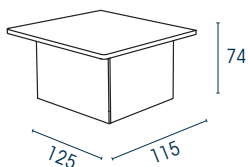
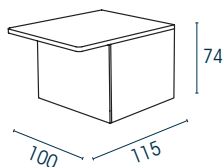

Habillages

(à commander obligatoirement)

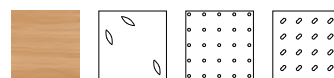

* PMR : personne à mobilité réduite

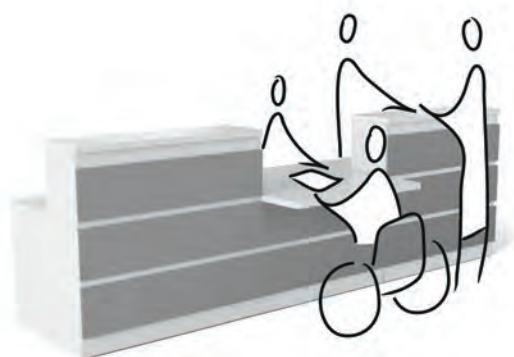

Banque pour grand espace

Multiplier les modules pour de plus grands accueils

Nuancier

Mélamine

Plateaux ép. 38 mm



Mélamine

Habillages ép. 19 mm

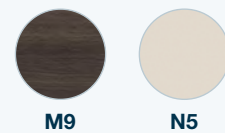
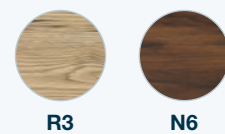

Métal

Habillages

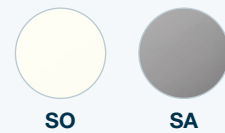

TARIF P. 13

Détails et disponibilités

TOUTES LES RESSOURCES EN LIGNE





Greta

UNE BANQUE POUR CHAQUE ESPACE

Sa grande variété de modules et ses rangements complémentaires permettent à GRETA de s'adapter à toutes les typologies d'accueil. Décorative, ses panneaux frontaux et latéraux habillent les espaces avec élégance.

Fabriqué
en France



Surface
antibactérienne





Fonctionnels, les plateaux et rangements disposent d'échancrure pour faciliter l'électrification des banques en toute discrétion.

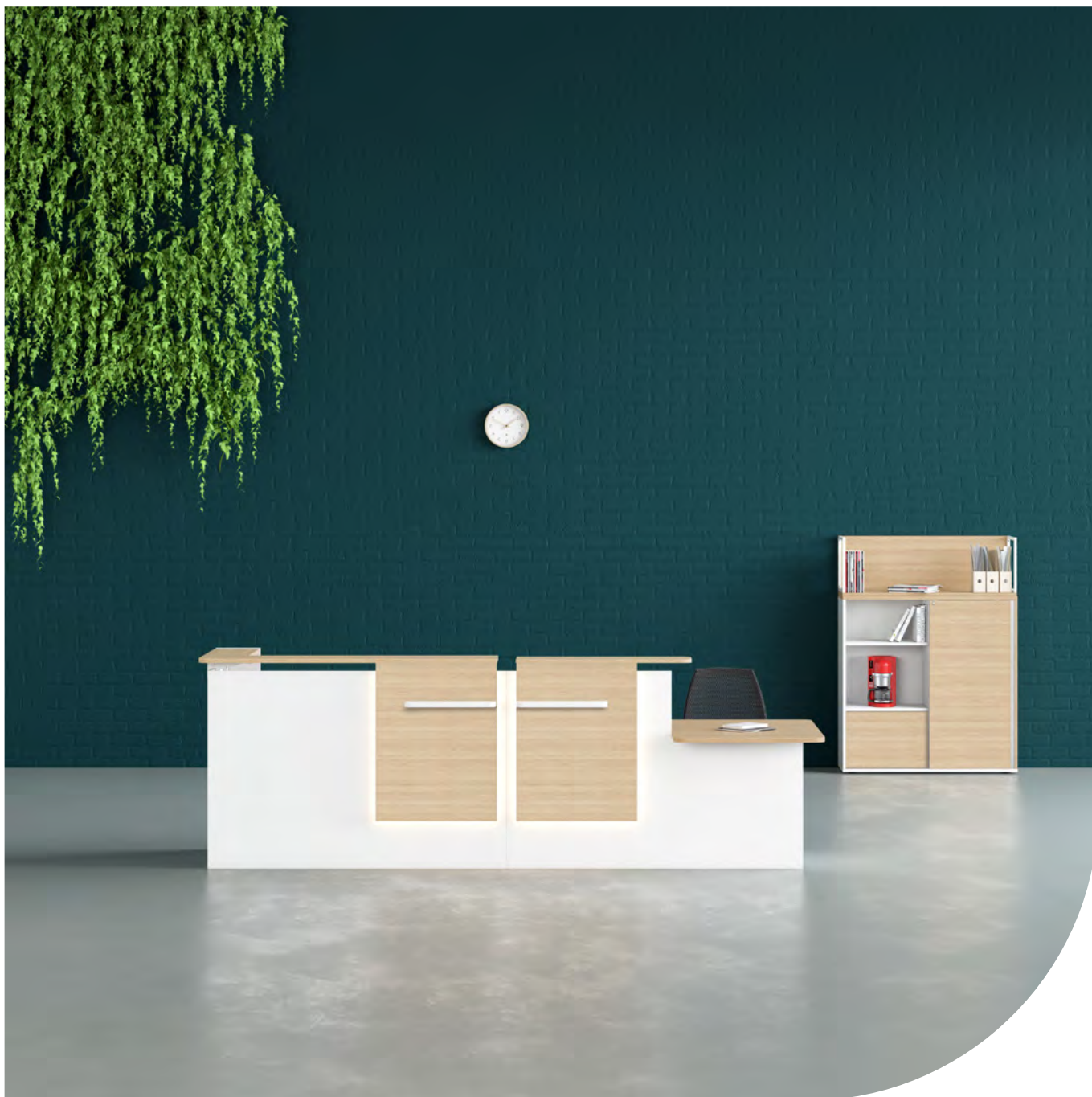

Zoom



Ergonomie utilisateur

Plateau avec échancrure pour intégration d'écrans jusqu'à 21 pouces

Options



Électrification discrète

Échancrure intégrée dans le bas des meubles de rangement



Kit led

Blanc ou couleur (à placer derrière l'habillage frontal)



Tiroir

Pour dossiers suspendus (en option)



Complète & fonctionnelle

Une banque d'accueil
aux dimensions compactes



Habillage frontal
Avec tablette repose sac

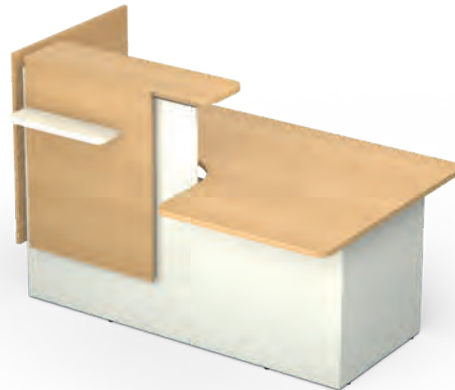
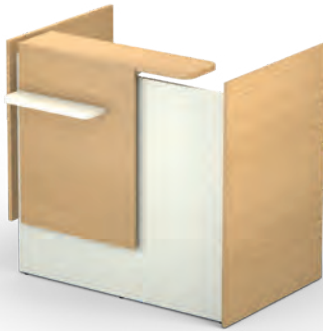

Panneaux décoratifs

Une base de structure en mélamine blanche qui vient s'agrémenter d'habillages frontaux (option) ou latéraux. Habillages coordonnés aux plateaux.

Module PMR

Spécialement adapté aux personnes à mobilité réduite.

Des rangements coordonnés

- Avec top pré-percé pour obturateur optionnel
- Avec porte coulissante + serrure intégrée
- En option : tiroir pour dossiers suspendus



Composer GRETA



Exemples de configurations



Recevoir du public des deux côtés

Avec un module d'angle et un module PMR en extrémité.



Rangement intégré

Un rangement juxtaposé apporte

- Côté utilisateur, un rangement complémentaire
- Côté visiteur, un accès à la documentation officielle de l'entreprise



Synoptique

Modules hauts

Module d'angle

- Réception assis
- Plan de travail H. 73.5 cm

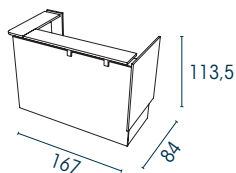

Modules droits

- Réception assis
- Plan de travail H. 73.5 cm

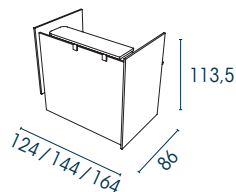

- Réception debout
- Plan de travail H. 95 cm

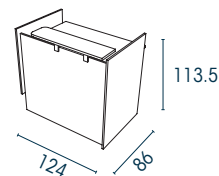

Modules PMR*

Réception assis/debout

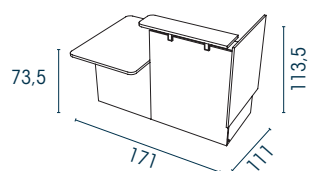

* PMR : personne à mobilité réduite

Réception assis

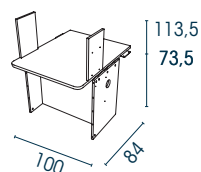

Rangements

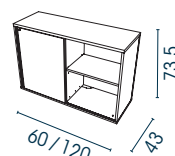
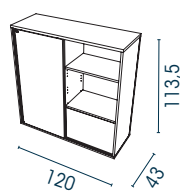

Options

Tiroir

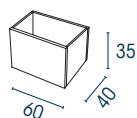

Tablette à poser ou à fixer

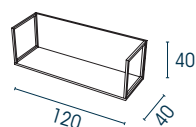

Habillage frontal

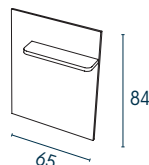

Nuancier

Mélamine

Structure banque ép. 25 mm
Corps des rangements ép. 19 mm



MG

Habillages frontaux ou latéraux ép. 19 mm



MG



RI



R3



N6



M9



N5



Adaptée à tous publics

Intégrer un module PMR aux extrémités ou au centre de la banque permet de varier les postures d'accueil : assis ou debout.

TARIF P. 15

Détails et disponibilités

TOUTES LES RESSOURCES
EN LIGNE





Evasion

+ Moderne & Chaleureux



Un design contemporain avec des assises en hêtre multiplis

Pour un accueil chaleureux & moderne

Assise en retrait du pied

(évite les frottements contre le mur)

Emplacement des assises et des tablettes au choix

Piètement aluminium brossé

Nuancier

Hêtre multiplis

Assises



VK
Blanc



VM
Noir

Métal

Traverses



SB
Aluminium



SG
Noir

Fabriqué
en France



TARIF P. 17

Détails et disponibilités

**TOUTES LES RESSOURCES
EN LIGNE**





Rosalie



Assise en retrait du pied
(évite les frottements contre le mur)

4 couleurs au choix
pour un accueil au style coloré

Assise enveloppante et confortable

Coque lavable
(polypropylène)

Emplacement des assises et des tablettes au choix

Piètement aluminium brossé

Fabriqué en France



Nuancier

Polypropylène
Assise



PS
Blanc crème



PQ
Gris



PJ
Jaune



PR
Noir

Métal
Traverses



SB
Aluminium



SG
Noir

TARIF P. 17

Détails et disponibilités

TOUTES LES RESSOURCES EN LIGNE



Sosi



Coque lavable & résistante
(assise et dossier métallique)

Poutre disponible avec et sans tablette

Emplacement des assises et des tablettes au choix

Fixation au sol disponible sur demande
(nous consulter)

Nuancier

Métal
Traverses



SB
Aluminium



SG
Noir

TARIF P. 17

Détails et disponibilités

TOUTES LES RESSOURCES EN LIGNE



Fabriqué en Europe







Espaces de travail







Bureaux de direction



Karl
Élégant & noble

Page 60 ›

.....



Kara
Statutaire & complète

Page 64 ›

.....



Moka
Intemporel & fonctionnel

Page 70 ›

.....



Rio
Moderne & sobre

Page 74 ›

.....



Robin
Tendance & naturel

Page 78 ›

.....



Karl

ÉLEGANCE ET CARACTÈRE DES ESPACES DÉCISIONNELS !

Karl se distingue par l'élégance de son dessin et la noblesse de ses matériaux. Ses lignes épurées imposent un style distinctif aux espaces Premium. Disponible en mélamine standard, linoléum ou mélamine noir velours, KARL se caractérise par la résistance et la texture douce de ses plateaux.

Fabriqué
en France





Pour les managers au style collaboratif, une table carrée pour travailler et réunir son équipe en même temps.



Synoptique

Bureaux individuels

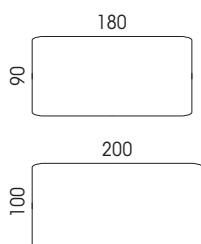

Connectique

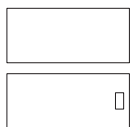

Bureaux / Réunion

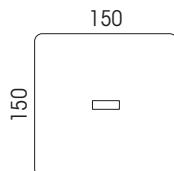

Rangements

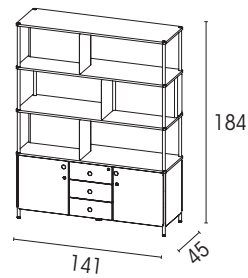
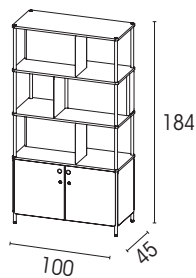
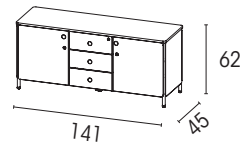
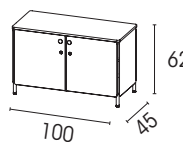

KARL existe aussi en version
réunion p. 158



Elégant & Noble



Elégance des espaces

Des formes douces alliées à des matières nobles (pied en chêne massif)

Textures douces et uniques

Au choix,

- Toucher velours et haute résistance avec la mélamine MK
- Toucher doux et surface mate avec le plateau en Linoléum (cf. plus de nuances p. 285)

Electrification discrète

Passage de câbles intégré au piétement. Dessus des trappes coordonné au plateau



Zooms



Pied électrifié

Accès aux câbles par un cache en bois à visser (version plateau avec trappe)



Trappe soft closing

Assortie à la couleur du plateau

Nuancier

Mélamine

Plateaux ép. 25 mm, top des crédences



N5



MK

Mélamine noir velours

Top crédence et tablettes bibliothèque



RI

Linoléum

Plateaux ép. 20,6 mm



LU

Bois massif

Piétements bureau



CM

Métal

Structure bureaux et rangements (montants et portes), voile de fond



ZP



ZC

TARIF P. 20

Détails et disponibilités

TOUTES LES RESSOURCES EN LIGNE





Kara

OPTIMISER SA SURFACE DE TRAVAIL AVEC ÉLEGANCE

KARA se distingue par l'épaisseur de son plateau et l'intemporalité de ses lignes. Fonctionnels, ses différents retours offrent une belle surface de travail.

Fabriqué
en France





Des rangements spécifiquement coordonnés complètent l'ensemble pour une décoration harmonieuse.



Caissons
2 ou 3 tiroirs



Bibliothèques



**Armoires avec
aménagement**

Au choix :

- Avec portes battantes et/ou coulissantes
- Avec ou sans bloc tiroir



Statutaire & Complète

Statutaire

Des formes droites, un plateau épais qui donne du caractère aux espaces de direction

.....

Complète

Des configurations de bureaux variées, complétées de rangement

.....

Détail des finitions

Caisson et retour, avec ou sans top verre

.....

Electrification discrète

Plans de travail pré-perçés et retours équipés d'obturateurs

.....





Composer KARA



Choisissez votre retour !

.....

Avec un caisson porteur pour optimiser sa surface et gagner en rangement

.....

Avec un retour aligné pour optimiser les m²

.....

Avec un retour débordant pour gagner en surface de dépose et libérer son espace de travail



Synoptique

Bureaux individuels

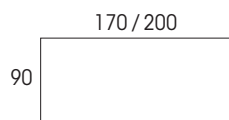

Bureaux avec retour

Aligné

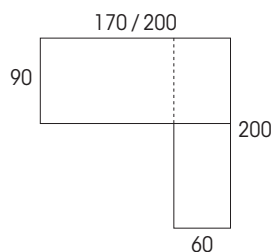

Débordant

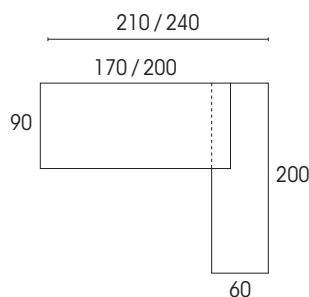

Bureaux avec caisson porteur

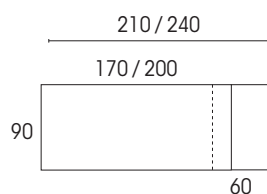

Bureaux avec retour et caisson porteur

Aligné

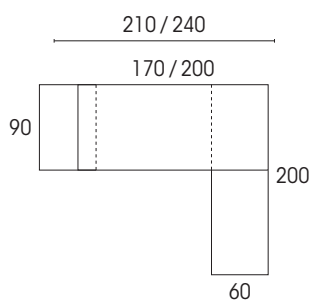

Débordant

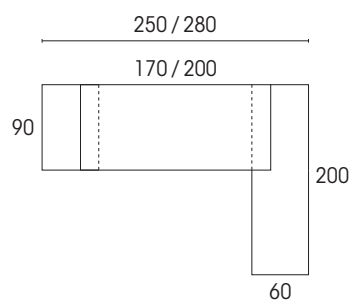

Rangements

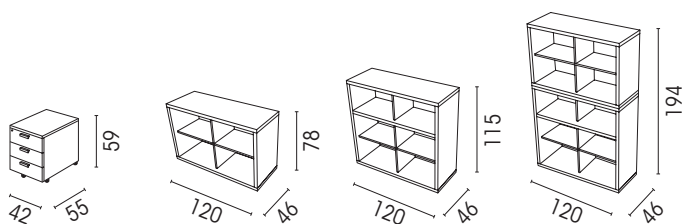

Rangements ouverts ou fermés : différents aménagements au choix, cf. tarif

Connectique

Bureaux

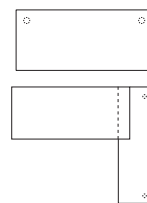

Nuancier

Mélamine

Plateaux ép.38 mm, piétement, retour et caisson



RI



N6



M9

Verre

Top caisson, retour ép.6 mm



GS



Encore plus de possibilités de rangement Cf. ARMAND p. 140

TARIF P. 21

Détails et disponibilités

TOUTES LES RESSOURCES EN LIGNE





Moka

LE CLASSIQUE INDEMODABLE !

MOKA fait partie des grands classiques de la direction. Ses pieds panneaux réhaussés d'une entretoise apportent de l'allure au bureau.

Fabriqué
en France



Surface
antibactérienne





Astucieux, son retour porteur offre un rangement complémentaire et optimise la surface de travail.
Au choix, il s'ouvre côté circulation ou utilisateur.



Synoptique

Bureaux indépendants

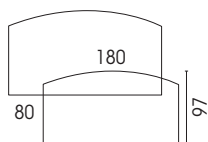

Bureaux avec retour porteur

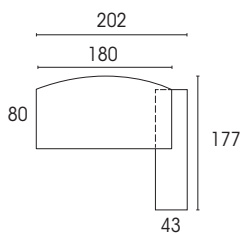
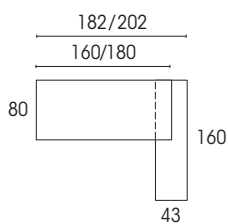

Bureaux panoramiques

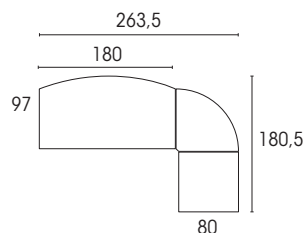
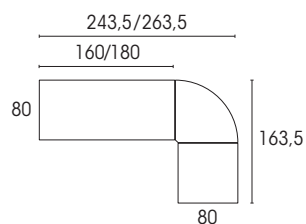

Angle de liaison

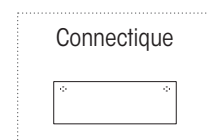
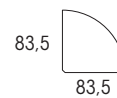

Rangements

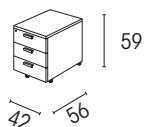
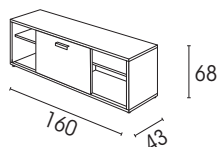

 Encore plus de possibilités de rangement
ARMAND p. 140



Intemporel & fonctionnel



Choix des configurations

Avec retour sur rangement porteur ou version panoramique

Voile de fond structurel

Avec perforations en partie supérieure pour le passage des câbles

Electrification

Plateaux pré-perçés pour obturateurs (option)

Nuancier

Mélamine

Plateaux ép. 25 mm
Piètement, rangement



R1



N6

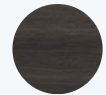

M9

Porte coulissante du rangement



N5

Retour porteur



Accès au rangement

Côté utilisateur



Côté visiteur

TARIF P. 24

Détails et disponibilités

TOUTES LES RESSOURCES EN LIGNE





Rio

BRILLANCE ET LUMINOSITE !

Avec son esthétique sobre et moderne, RIO aménage les postes manager autant dans les espaces ouverts que les bureaux fermés. Dans sa version verre, il apporte brillance et luminosité à l'espace.

Fabriqué
en France





Différentes configurations au choix : avec ou sans retour, avec ou sans rangement, plateaux verre ou mélaminé, RIO s'adapte à chaque usage.



Synoptique

Bureaux individuels

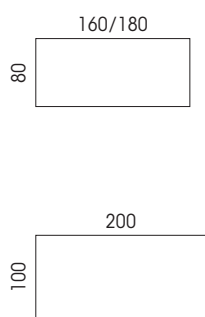

Bureaux avec rangement porteur

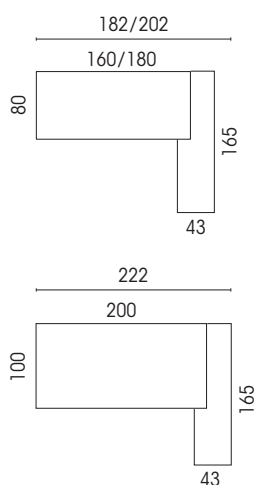

Bureaux avec retour suspendu

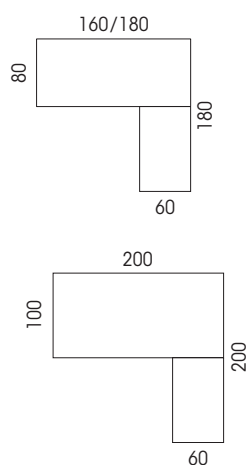

Connectique

Pour plateaux mélamine
Bureaux

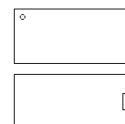

Tables de réunion



Retours

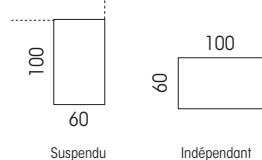

Tables de réunion

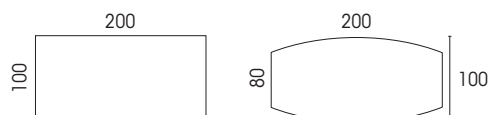



Moderne & sobre



Design intemporel

Piètement arche
Section rectangulaire
(60 x 30 mm)

Elégance des espaces

Effet aérien grâce au plateau
surélevé

Electrification variée

Obturateurs ou trappe
(pour plateau mélamine)

3 types de retour



Avec rangement porteur



Suspendu



Indépendant

Nuancier

Mélamine

Plateaux ép. 25 mm



RI



R3



N6



MK

Mélamine
noir velours

Verre

Plateaux ép. 8 mm



GS

Métal

Piètement



SO



SA



SG

Altuglas

Portes rangement
porteur



OA

TARIF P. 26

Détails et disponibilités

TOUTES LES RESSOURCES
EN LIGNE





Robin

[] 2 positions de rangement



[] Option



Fabriqué
en France





Tendance & Naturel



Design contemporain

Piètement arche en hêtre massif. Il apporte douceur et chaleur aux espaces de direction

Rangement sécurisé

Porte avec fermeture à clé

Electrification variée

Obturateurs ou trappe décentrée. Descente de câbles intégrée dans le rangement porteur

Synoptique

Bureaux individuels

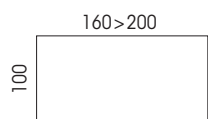

Bureaux avec rangement porteur

Aligné

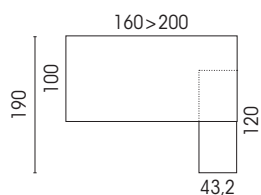

Débordant

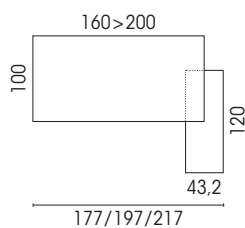

(à positionner à droite ou à gauche)

Connectique

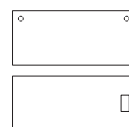

Nuancier

Mélangine

Plateaux ép.25mm, corps des rangements. (Porte coulissante assortie au plateau)



MG



N5



RI



MK/N9*

*Mélangine noir velours MK sur les surfaces horizontales (surfaces verticales en N9 mélangine noir)

Métal

Piètement (traverse) (Poignée porte assortie)



SO



SG

Bois

Piètement



MS

TARIF P. 28

Détails et disponibilités

TOUTES LES RESSOURCES EN LIGNE



Existe aussi en version Bureaux collaboratifs p. 96 et en version Réunion p. 174



Bureaux collaborateurs & séparations



Homère
Retour pivotant

HOME OFFICE

Page 82 ›



Axel 2 NOUVEAU
Pied I
Centrés motorisés et manivelle

ASSIS/DEBOUT

Page 86 ›



Lutz 2 NOUVEAU
Pied I
Centrés motorisés

ASSIS/DEBOUT

Page 92 ›



Robin
4 pieds
Bois massif

BUREAUX

Page 96 ›



Conect
Piètement arche
ou boucle

BUREAUX

Page 100 ›



Arial
Piètement arche
(existe en mobile)

BUREAUX

Page 106 ›



Idol
Pied centré
ou décentré

BUREAUX

Page 110 ›



Forstyl
Pied L ou panneau

BUREAUX

Page 114 ›



Solange
Ecrans et cloisons

SÉPARATION

Page 116 ›
.....



Twins
Ecrans et cloisons

SÉPARATION

Page 122 ›
.....



Lucien
Ecrans avec rails

SÉPARATION

Page 123 ›
.....



Homère

Mobile

Il se déplace selon les besoins (roulettes tous types de sol dont 4 avec frein)

Modulable

Le plateau coulissant et pivotant transforme l'usage du bureau

Pratique

Module de rangement avec cases ouvertes et tiroir

Faible encombrement

En mode repos, l'espace est optimisé

Fabriqué
en France



Surface
antibactérienne





Le bureau idéal pour la maison !



Configurations



Mode repos

Position fermée
0,51 m² au sol
L. 102 x P. 50 cm



Mode travail

Bureau avec plateau aligné
0,81 m² au sol
L. 161,5 x P. 50 cm



Mode travail

Bureau avec retour
1,2 m² au sol
L. 107 x P. 112,5 cm

Nuancier

Mélangé

Corps des meubles
Ep. 19mm



R3

Plateau pivotant
Ep. 25 mm



MG



MK
Mélangé
noir velours

TARIF P. 29

Détails et disponibilités

TOUTES LES RESSOURCES EN LIGNE





© Dragonimages

7h

C'est le temps que
70% de la population
passe chaque jour
en position assise

Pourquoi un poste assis-debout ?

Le corps humain est prédestiné à bouger. Pourtant, la vie moderne, le télétravail nous cantonne souvent à passer de longues heures assis sur une chaise. Une sédentarité qui n'est pas sans risque pour la santé.

Les risques de la sédentarité



Troubles
musculo
squelettiques



Troubles
de santé
mentale



Pathologies
cardio-vasculaires



Diabète
(Type 2)



Levez-vous et alternez les postures

Selon les utilisateurs de bureaux réglables*

88%

Indiquent
que les bureaux
assis debout sont
faciles à utiliser

47%

Ressentent
une amélioration des
tensions au niveau du dos,
du cou et des épaule

65%

S'estiment
plus concentrés
et productifs

Travailler debout **augmente de 10 % la productivité**

La bonne posture

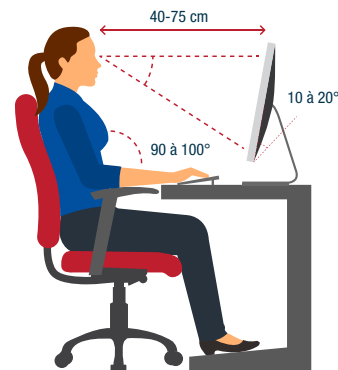
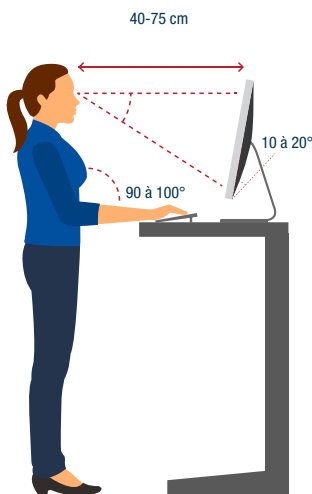

RÉGLAGE DE L'ÉCRAN

La hauteur de l'écran doit se situer au niveau des yeux, et légèrement inclinée. La distance de l'écran doit être égale au bras tendu.

POSITIONNEMENT DES PIEDS

Les pieds doivent être bien ancrés au sol, écartés de manière à former un triangle entre jambes et bassin.

POSITIONNEMENT DES BRAS

En posant la main sur la table, le coude doit faire un angle droit. Les épaules doivent être détendues, les avant-bras parallèles au sol. Flexion minimale au poignet.

COMMENT ALTERNER LES POSTURES ?

Pour chaque 30 minutes travaillées,

- Restez assis 20 minutes
- Debout 8 minutes
- Déplacez et étirez-vous pendant les 2 minutes restantes

Toutes les 20 minutes, alternez entre position assise et position debout

* Source - Etude Stand Up to Work: assessing the health impact of adjustable workstations" (2018)



Axel 2

NOUVEAU

LE BUREAU QUI VOUS VEUT DU BIEN

Axel 2 participe directement au bien-être des collaborateurs en permettant à son utilisateur d'alterner les postures entre travail assis ou debout, prévenant ainsi la sédentarité au travail. En espace de travail individuel, collectif ou de réunion, Axel 2 offre une solution ergonomique adaptée.





Disponible en version électrique ou manivelle, Axel 2 apporte une offre complète de bureaux et tables de réunion conçue pour s'adapter à chaque situation et encourager le mouvement tout au long de la journée de travail.



Multiusage & ergonomique

Multi espaces

Un synoptique varié pour équiper autant les open spaces en bureaux que les espaces réunion

.....

Personnalisable

Gestion variée de l'électrification
Possibilité d'ajouter des écrans de séparation

.....



Optimisé

Châssis télescopique pour plateaux de 120 à 180 cm

.....

Sécurisant

Système anti-collision intégré (pour la version motorisée)

.....

Système motorisé performant

1 moteur par colonne

Options



Mobile

Roulettes discrètes avec frein Ø 40 mm (tous types de sol). Vérins de mise à niveau en version fixe



Panneaux écrans tissu

Acoustiques ou non acoustiques



Choisir son type de réglage



Réglage par manivelle

Ajustable H. 71.5 à 115.5 cm

- Permet un positionnement précis sans branchement électrique
- Pied gradué au pas de 1 cm
- Facile à manipuler
- Manivelle rétractable sous plateau
- Uniquement bureaux individuels et structure partagée



Réglage par système motorisé

Ajustable H. 65 à 130 cm

Boîtier de commande intuitif pour les bureaux, idéal pour le Flex office :

- Ecran LCD Haute résolution avec menu déroulant
- Mémoires de position : 4 utilisateurs ont la possibilité de choisir chacun 2 positions assis ou debout
- Alarme de rappel pour se lever
- Autres possibilités de réglage



Accès direct à 1 port USB chargeur (A+C)



Boîtier simple pour les tables de réunion

- 4 mémoires de position



Options



Electrification facilitée

Goulotte intégrée permettant le stockage des boîtiers prises (version structure partagée).
Montée de câbles optionnelle



Gestion verticale des câbles

Vertèbre extensible ou carter aimanté



Composer Axel 2



Bureau individuel

Positionné en vis à vis ou seul, Axel 2 permet à chaque collaborateur d'alterner les postures.



Bureau avec retour

Pour une surface de travail optimisée, les bureaux Axel 2 offrent une zone de travail principale et une zone complémentaire.



Synoptique

Bureaux individuels

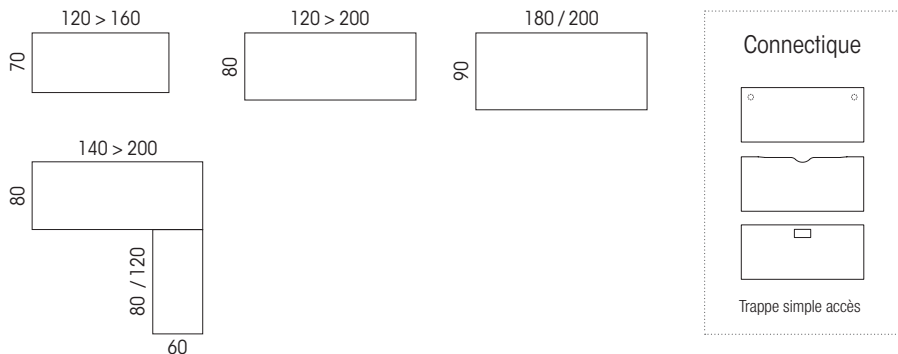

Bureaux structure partagée

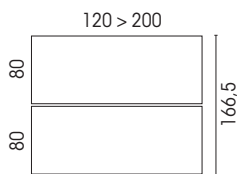

Panneaux écrans

Pour bureaux structure partagée

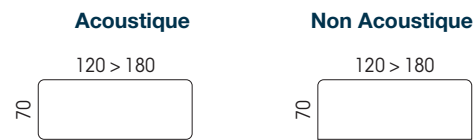

Pour les bureaux individuels, retrouvez les offres du catalogue, SOLANGE et TWINS

Tables de réunion

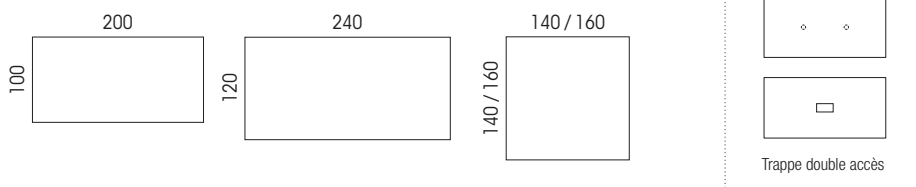

Bureau partagé

La version duo permet d'équiper les open space et d'encourager la communication des collaborateurs tout en laissant le choix à chacun de personnaliser sa hauteur.

En réunion

Au choix plusieurs dimensions et formats de tables pour alterner les postures et dynamiser les échanges.

Nuancier

Mélanges

Plateaux ép. 25 mm

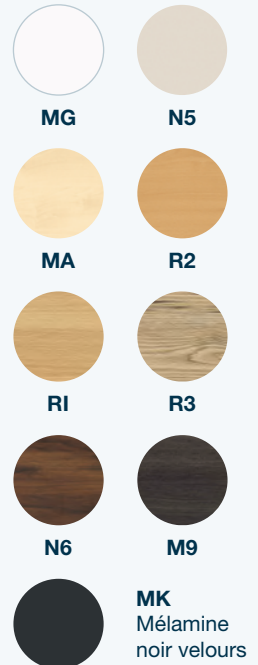

Métal

Piètements



Tissu

Écrans

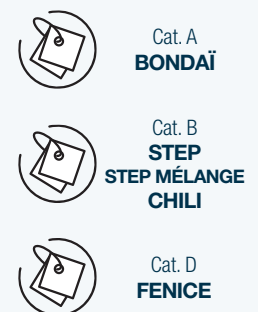

TARIF P. 29

Détails et disponibilités

TOUTES LES RESSOURCES EN LIGNE





Lutz 2

NOUVEAU

LE POSTE ASSIS-DEBOUT ACCESSIBLE

Une offre de bureaux individuels avec système motorisé à prix économique, pour alterner les postures et lutter contre la sédentarité.



Surface
antibactérienne





Pratique, son boîtier de commande à mémoires de position offre également un accès direct à un port USB chargeur A+C. Il intègre également une alarme pour rappeler à l'utilisateur de se lever.



□ Synoptique

Ép. 19 mm

120 > 160



Ép. 25 mm

120 > 180



Connectique



Ép. 19 mm

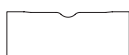
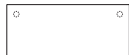

Ép. 25 mm

□ Réglages



Motorisé



- Ajustable H. 71.5 à 117.5 cm
- Boîtier de commande avec affichage digital
- 3 mémoires de position
- 1 USB chargeur (A+C) intégré
- Alarme de rappel pour se lever
- Autres possibilités de réglages



Economique & ergonomique

Optimisé

Une seule structure réglable pour plateaux L. 120 à 180 cm

Choix des plateaux

Ép. 19 mm ou 25 mm



Electrification variée

Obturbateurs, échancrure ou trappe

Sécurisant

Système anti-collision intégré

Esthétique

Embase arrondie avec vérins ajustables

Nuancier

Mélamine

Plateaux ép. 19 mm* ou 25 mm



MG



N5



MA



R2



RI



R3



N6

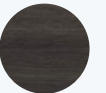

M9



MK
Mélamine noir velours

* Les plateaux ép. 19 mm sont disponibles avec les finitions RI et MG uniquement

Métal

Piètement



SO



Z4



SG

TARIF P. 34

Détails et disponibilités

TOUTES LES RESSOURCES EN LIGNE



Options



Roulettes discrètes

Avec frein ø 40mm (tous types de sol)



Vertèbre extensible

(à fixer sous le plateau)



Cartier aimanté

(se positionne sur le piètement)



Robin

DES LIGNES DOUCES ET NATURELLES

Inspiré des codes de l'habitat, Robin se distingue par l'élégance de son piétement en bois massif. Légèrement arrondi, il apporte douceur et chaleur aux environnements de travail.

Fabriqué
en France



Surface
antibactérienne





Une offre complète qui équipe autant les espaces manager, que les espaces collaboratifs ou de réunion.



Synoptique

Bureaux individuels

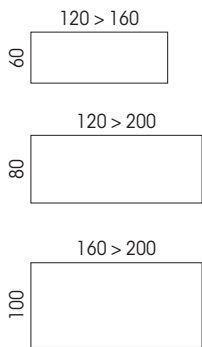

Bureaux structure partagée

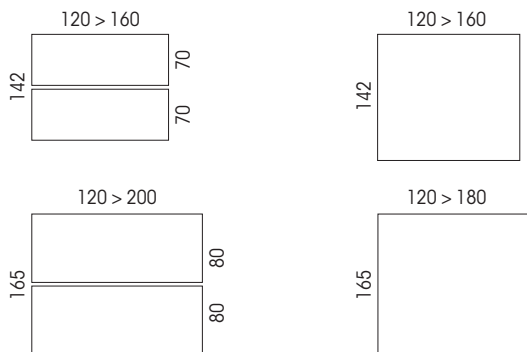

Extensions

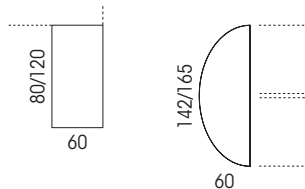

Connectique

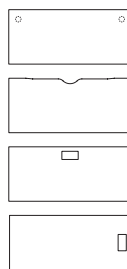

Uniquement plateaux p.100 cm



Tendance & Naturel



Bureaux structure partagée

P. 142 ou 165 cm

Mono plateau ou double plateaux



Bureaux individuels

P. 60 à 100 cm



.....

Design contemporain

Piètement arche en hêtre massif. Il apporte douceur et chaleur aux espaces de travail

.....

Electrification variée

Obturbateurs, échancre ou trappe

.....

Montage Rapide

Pieds et traverse livrés assemblés



Zoom



Pied incliné

En hêtre massif
Traverse en métal



Option



Voile de courtoisie

Au choix tissu, mélamine ou métal

Nuancier

Mélamine

Plateaux ép. 25 mm



MG



N5



RI



MK

Mélamine
noir velours

Métal

Piètement (traverse)



SO



SG

Bois massif

Piètement



MS

TARIF P. 35

Détails et disponibilités

TOUTES LES RESSOURCES
EN LIGNE





Conect

L'ALLIÉ DES BUREAUX PARTAGÉS

Un piètement arche ou boucle aux lignes épurées, un plateau légèrement surélevé pour une silhouette aérienne... CONECT apporte de la légèreté aux espaces de travail.

Fabriqué
en France





Sa structure monobloc en fait aussi l'allié des bureaux partagés. Avec son système de bureaux départ et suivant, CONECT se multiplie à l'infini en fonction de l'espace disponible et de la population à équiper.



2 types de piètement



Arche

FIXE H. 73,5 cm
RH 62 à 86 cm



Boucle

FIXE H. 73,5 cm



Intemporel & polyvalent

Bureaux individuels

P. 60 à 80 cm



Bureaux structure partagée

p. 142 et 165 cm

Existe en mono ou double plateaux



Design intemporel

Piètement arche ou
boucle mono bloc
Section rectangulaire
(60 x 30 mm)

Élégance des espaces

Plateau surélevé du piètement
pour un effet aérien

Electrification variée

obtrateurs, échancrure
ou trappe



Composer CONECT



Exemples de configurations



Travailler

Optimiser sa surface en optant pour un caisson porteur sous le retour



Ranger

Choisir un rangement de proximité. Il offre un rangement complémentaire en même temps qu'un retour



Synoptique

Bureaux individuels

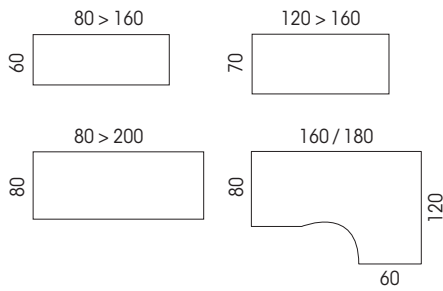

Bureaux structure partagée

Existent aussi en version bench plateaux coulissants

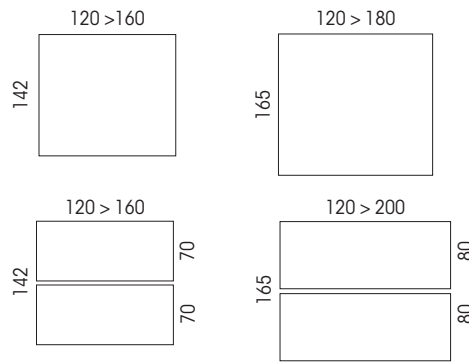

Bureaux individuels avec rangement

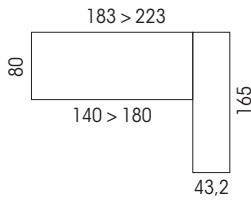

Bureaux structure partagée avec rangements

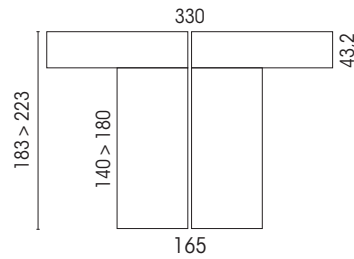

Retours

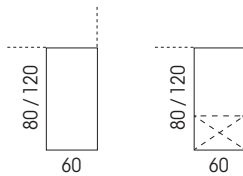

Extensions

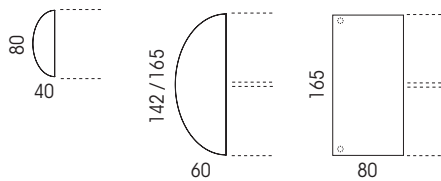

Connectique

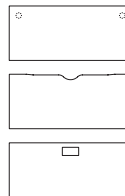

Se réunir

En version Monobloc, et selon la connectique choisie, le plateau sert autant de bureau que de réunion

Nuancier

Mélamine

Plateaux ép. 25 mm

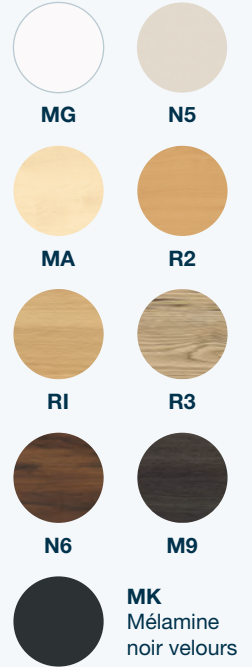

Métal

Piètements

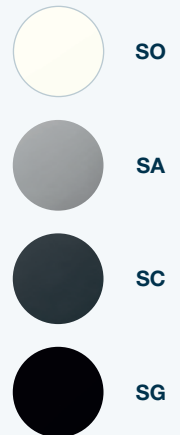

TARIF P. 38

Détails et disponibilités

TOUTES LES RESSOURCES EN LIGNE





Arial

RENDRE L'ESPACE AGILE

Dotés de formes simples et d'un large synoptique, les bureaux Arial s'adaptent autant aux espaces de travail, de réunion que de formation.

Fabriqué
en France



Uniquement pour les bureaux fixes (sans roulettes)
et RH plateaux ép. 25 mm - Hors finitions MK-N9

Surface
antibactérienne



Sa version mobile apporte de l'agilité aux environnements de travail. Elle permet aux collaborateurs de choisir la configuration la mieux adaptée à leurs usages sans changer de pièce.



Synoptique

Bureaux individuels



 Existe en version mobile h.73,5 cm

Bureaux structure partagée

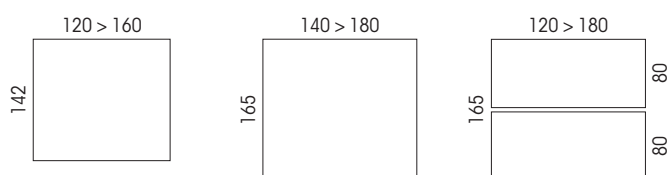

Retours

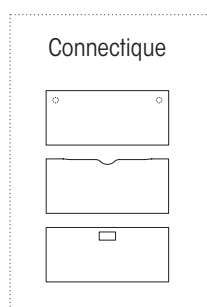

- Plateaux ép. 19 mm disponibles uniquement pour bureaux P. 80 et P. 165 cm
- Plateaux nus pour bloc prise indépendant



ARIAL existe aussi en version Réunion p.168



Simple & agile

Bureaux individuels

p. 80 et 90 cm



Bureaux structure partagée

p. 142 et 165 cm.

Existe en mono plateau
ou double plateaux



Design Minimaliste

Des formes simples
qui s'adaptent à
tous les espaces.
Piètement section carrée
(50 x 50 mm)

Polyvalente

Un synoptique varié pour
équiper autant les espaces de
travail que les espaces réunion
ou formation (cf. ARIAL
réunion p. 168)

Electrification variée

obturbateurs, échancrure
ou trappe

2 types de piètements

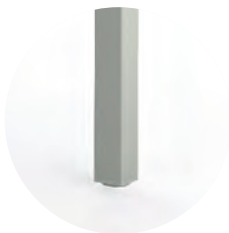

Arche

Pour bureau individuel
et structure partagée

FIXE H. 73,5 cm
RH 62 à 86 cm



Arche mobile

Pour bureau individuel

FIXE H. 73,5 cm
(Roulettes noires avec frein, tous
types de sols)

Nuancier

Mélamine

Plateaux ép. 19 mm*
ou 25 mm



MG



N5



MA



R2



RI



R3



N6

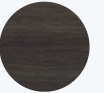

M9



MK

Mélamine
noir velours

* Les plateaux
ép. 19 mm sont
disponibles avec les
finitions RI et MG
uniquement

Métal

Piètements



SO



SA



SC



SG

TARIF P. 42

Détails et disponibilités

TOUTES LES RESSOURCES
EN LIGNE





Idol

↑
Casiers CAMILLE, p. 136 - Sièges LEON, p. 218

GESTION OPTIMALE DE L'ÉLECTRIFICATION

La forme du pied IDOL optimise le confort de son utilisateur en libérant l'espace sous le bureau. Il permet ainsi une plus grande liberté de mouvement des jambes. En plus, son carter clipsable, apporte une touche décorative en même temps qu'il masque l'électrification verticale du bureau.

Fabriqué
en France





Intemporel et polyvalent



Choix du type de pied

Centré ou décentré pour ne pas gêner le mouvement des jambes sous le plateau

Choix des plateaux

Plans droits, compacts asymétriques ou symétriques, pour des configurations multiples

Electrification horizontale

Plateau pré-percé pour obturateurs (option)

[o] 2 types de piétements

[o] Options



Centré

FIXE H. 73,5 cm
Avec ou sans carter
RH. 62 à 86 cm
carter inclus



Décentré

FIXE H. 73,5 cm
Avec ou sans carter



Carter décoratif

Il masque la descente des câbles



Voile de fond

Structurel pour pied décentré ou en option pour pied centré



Composer IDOL



Optimiser sa surface de travail

.....

Avec un retour équipé d'un caisson porteur pour plus de rangement et de surface de travail



.....

Avec un pied décentré qui inclut un voile de fond structurel



Synoptique

Bureaux individuels

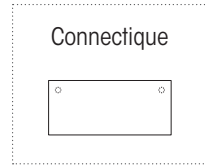
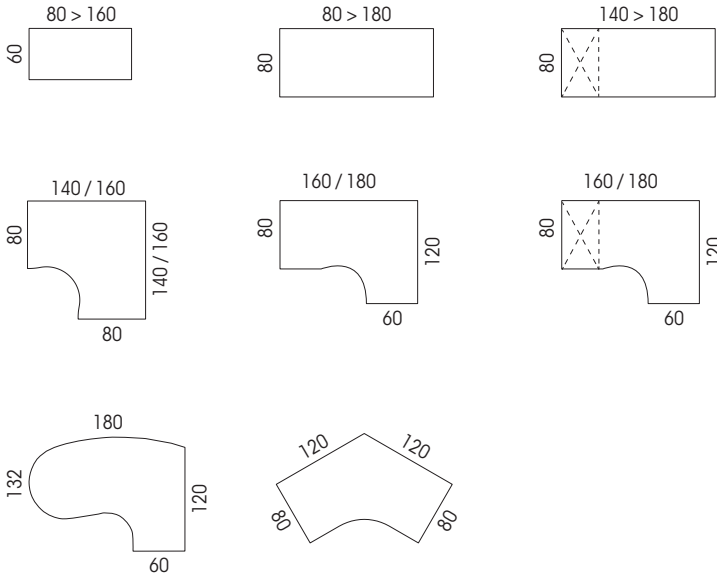

Retours

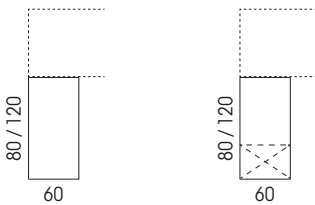



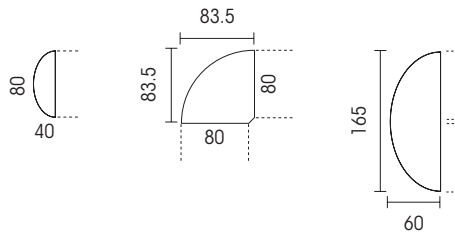



Extensions





Nuancier

Mélanges Plateaux ép. 25 mm

-  **MG**
-  **N5**
-  **MA**
-  **R2**
-  **RI**
-  **R3**
-  **N6**

Métal Piétements, carters

-  **SO**
-  **SA**
-  **SC**



Varier les configurations

Une configuration trio pour un espace confortable et convivial

TARIF P. 44
Détails et disponibilités

TOUTES LES RESSOURCES
EN LIGNE





Forstyl

Synoptique

Bureaux individuels

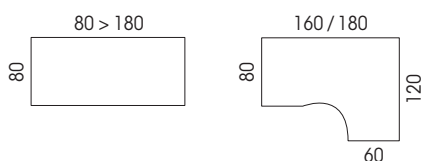

Extensions

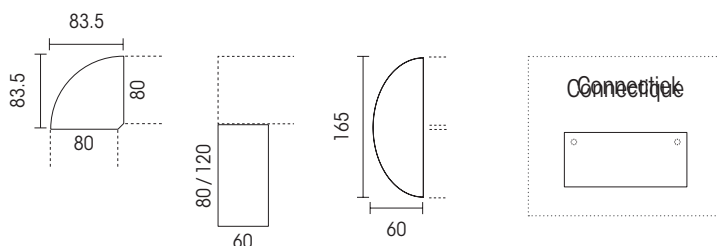

Fabriqué
en France





Décoratif & économique



Nuancier

Mélamine

Plateaux, pied
panneau, pied L
ép. 25 mm
et voile de fond



MG



R2



RI

Métal

Embase pied L



SA

Harmonie des finitions

Voile de fond structurel
assorti au plateau

Electrification horizontale

Plateau pré-percé pour
obturateurs (option)

Electrification facilitée

Voile de fond percé des
2 côtés pour permettre
le passage des câbles

[] 2 types de piétements



Pied panneau
H. 73,5 cm



Pied L
H. 73,5 cm

TARIF P. 47

Détails et disponibilités

**TOUTES LES RESSOURCES
EN LIGNE**





Solange

A CHACUN SON ESPACE

Caractérisées par des lignes douces, SOLANGE transforme avec élégance les espaces partagés en espaces privés propices à la concentration.

Fabriqué
en France





Son ingénieux système de liaison, sans outil, permet de combiner plusieurs écrans ou cloisons entre eux. Ainsi les espaces se reconfigurent à l'envi.



Astucieux et acoustique

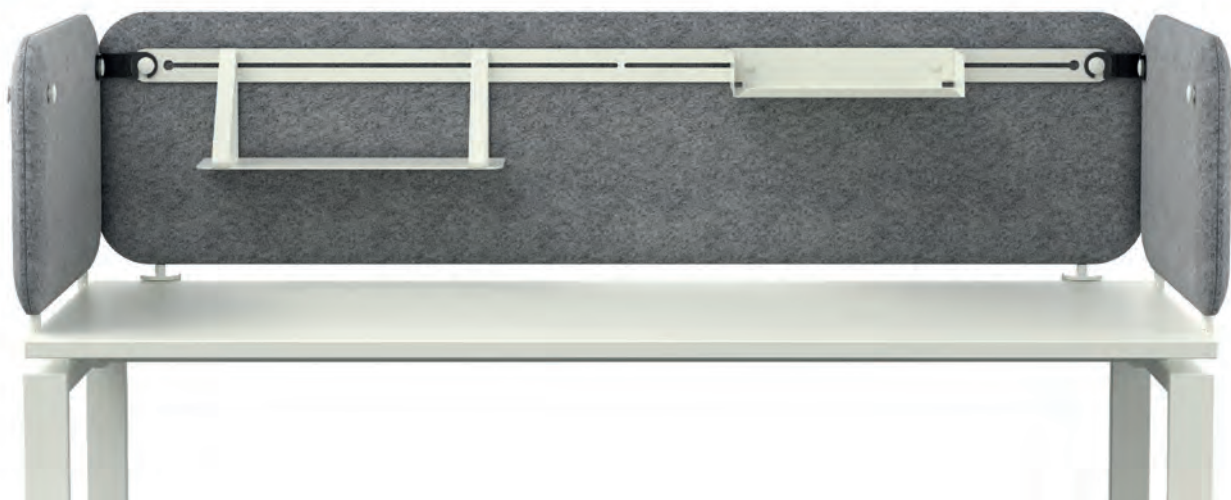

Un écran pour chaque usage

Version frontale ou latérale.
A poser ou à fixer

Pratique

Accessoires facilement repositionnables

Acoustique*

Environ 50 % des nuisances sonores absorbées

Recyclé et durable

Âme en coton recyclé pour les panneaux écrans H. 40 et 50 cm.
Âme en carton alvéolaire fabriqué à partir de fibres 100% recyclées recouvert d'une mousse de fibres polyester écologiques pour les panneaux écrans H. 70 cm et cloisons acoustiques

Compatible avec des plateaux ép. 19 à 30 mm

Zooms



↳ Boutons

Esthétiques et fonctionnels, pour intégration d'un rail porte-accessoires



↳ Version à poser

L'écran se pose et se dépose à volonté grâce au jeu de pieds



Montage & démontage sans outils



Douceur des angles

Pour un style contemporain



Astucieux

Un seul kit de liaison pour relier 2, 3 ou 4 cloisons, sans outils

Fixe ou mobile

(Roulettes tous types de sols)



Varié

Acoustique ou non acoustique

[] Options



◀ Kit de liaison

Pour relier cloisons ou panneaux écran



◀ Tableau écritoire

Avec plumier
Se pose sur les cloisons



Armoire acoustiques
CLAUDINE, (Exclu Web)
 - Bureaux **CONNECT**, p.100

Composer **SOLANGE**



Libérer sa surface de travail

Des accessoires pour personnaliser
 l'espace de chaque collaborateur



La version panneau écran H. 70
 sert aussi de voile de courtoisie



Synoptique

Paneaux écrans

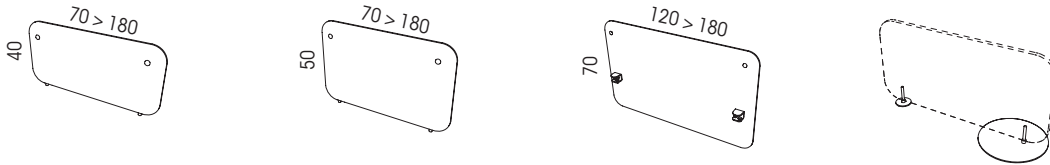

Pinces de fixation - Compatibles avec plateaux ép. 19 à 30 mm

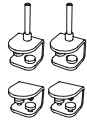

Fixation frontale postes individuels

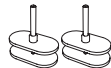

Fixation double postes vis-à-vis ou bench



Fixation traversante pour bench mono plateau

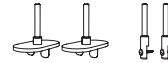

Fixation latérale en intermédiaire ou en extrémité

Rails et accessoires écrans

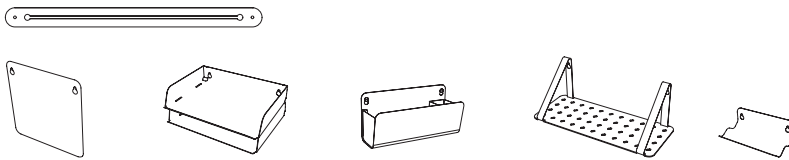

Cloisons

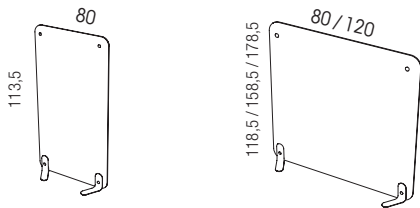

Accessoire cloisons



Tableau écriture blanc avec plumier et pinces métal

Kit de liaison écrans et cloisons



Pieds pour cloisons : fixes (configurations cloisons seules ou multiples) ou sur roulettes

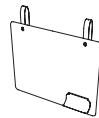

Séparer l'espace

En ligne ou en angle, fixe ou mobile, reconfigurez votre espace à volonté

Nuancier

Tissu

Ecrans et cloisons ép. 47 mm



Cat. A **BONDAÏ**



Cat. B **STEP**
STEP MÉLANGE
CHILI



Cat. D **FENICE**

Métal

Pinces, pieds, rails, accessoires



SO



SA



SC



SG

TARIF P. 49

Détails et disponibilités

TOUTES LES RESSOURCES EN LIGNE





Nuancier

Mélamine

Ecrans ép. 19 mm,
cloisons ép. 25 mm



MG

N5



MA

R2



RI

R3

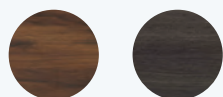

N6

M9



N9

Tissu

Ecrans & cloisons ép. 25 mm



Cat. A
BONDAl



Cat. B
**STEP
STEP MÉLANGE
CHILI**



Cat. D
FENICE

Métal

Pinces, pieds, rails,
accessoires



SO

SA



SC

SG

TARIF P. 52

Détails et disponibilités

**TOUTES LES RESSOURCES
EN LIGNE**



Twins

+ Idéal pour les petits budgets

Choix des dimensions

Écrans H. 40 cm (L. 80 à 200 cm)
Cloison H. 160 x L. 80 cm

Choix des matières

Mélamine ou tissu

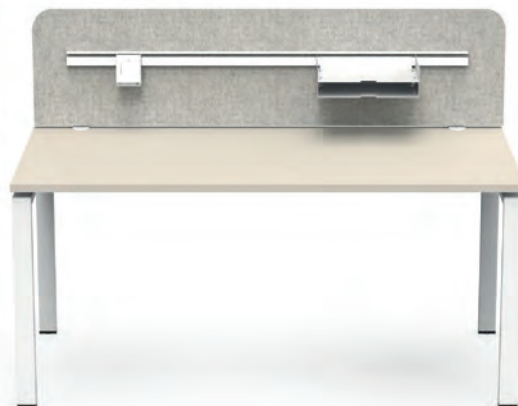

Recyclé

Panneaux issus de chutes
ou de panneaux déclassés
(pour les versions tissu)

Pratique

Accessoires à poser sur un rail
(bacs à courrier et pot à crayons)

* Pinces selon configurations (pour plateaux ép. 19 à 30 mm)

* Pieds fixes stabilisateurs pour cloisons

Fabriqué
en France



Surface
antibactérienne





Lucien

+ Robuste & acoustique

Robuste

Cadre en aluminium avec rail intégré
H. 40 cm (L. 80 à 180 cm)

Bras support écran

A fixer sur rail
(cf p. 274)

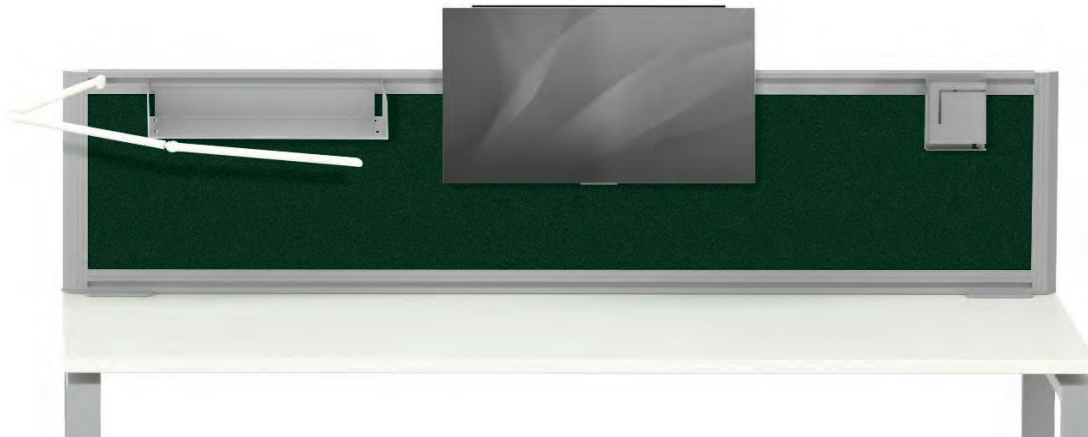

Pratique

Accessoires facilement repositionnables
(bacs à courrier et pot à crayons)

Acoustique

Environ 80% des nuisances
sonores absorbées

Nuancier

Tissu

Ecrans ép. 42 mm



Cat. A
BONDAÏ



Cat. B
STEP
STEP MÉLANGE
CHILI



Cat. D
FENICE

Métal

Cadre, pinces et
accessoires



SO



SA



SC

*Pinces selon configurations (pour plateaux ép. 25 à 30 mm)

*Kit connecteurs pour relier les panneaux écrans frontaux et latéraux

Fabriqué
en France



TARIF P. 53

Détails et disponibilités

**TOUTES LES RESSOURCES
EN LIGNE**





Rangements



James

RANGEMENT DE PROXIMITÉ

Page 126 ›

.....



Gustave

RANGEMENT DE PROXIMITÉ

Page 128 ›

.....



Mélina

RANGEMENT DE PROXIMITÉ

Page 130 ›

.....



**Caissons
mélamine éco**

RANGEMENT DE PROXIMITÉ

Page 133 ›

.....



Réhausse

RANGEMENT DE PROXIMITÉ

Page 133 ›

.....



Caissons métal

RANGEMENT DE PROXIMITÉ

Page 134 ›

.....



Camille

RANGEMENT COLLECTIF

Page 136 ›

.....



Armand

RANGEMENT COLLECTIF

RANGEMENT DE PROXIMITÉ

Page 140 ›

.....



Ariv

RANGEMENT COLLECTIF

Page 144 ›

.....



Classeurs

RANGEMENT COLLECTIF

Page 149 ›

.....



Navert

RANGEMENT COLLECTIF

Page 146 ›

.....



Rayonnages

RANGEMENT COLLECTIF

Page 150 ›

.....



Armoires démontables

RANGEMENT COLLECTIF

Page 148 ›

.....



Vestiaires

RANGEMENT COLLECTIF

Page 152 ›

.....



James

↑
Bureaux CONECT, p.100 - Panneaux écrans SOLANGE, p. 116
- Plantes décoratives, p. 268 - Lampadaire, p. 267

[] 2 pieds de soutien



◀ Pied incliné

Hêtre massif
(ROBIN)

◀ Pied droit

Métal
(CONNECT
et ARIAL)

[] Option



◀ Support courrier

à suspendre au
dos de la porte
du casier

Fabriqué
en France



Surface
antibactérienne





Décoratif & accessible



Accès immédiat

Cubes ouverts
en métal ou filaire

Accès sécurisé

Bloc 2 cases fermées
à clé pour ranger ses
effets personnels

Espace courrier

Porte avec fente
pour support courrier

Synoptique

Pour bench P. 165 cm*

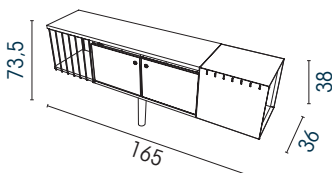
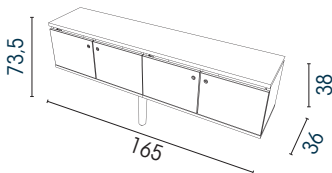

Pour bench P. 142 cm*

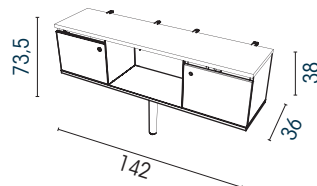

Options



Séparateur métal 4 cases
(uniquement pour Bench
P.142 cm)



Support courrier

Nuancier

Mélangine

Corps, top, façade



MG

N5



MA

R2



RI

R3

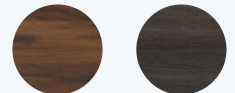

N6

M9



MK/N9*

* MK/N9 : Top des
meubles en Noir
velours MK/ Corps et
façades en Noir N9

Métal

Cubes, pied de soutien
(ARIAL, CONECT),
options



SO

SA



SC

SG

Métal/Bois massif

Pied de soutien (ROBIN)



SOMS

SGMS

TARIF P. 56

Détails et disponibilités

TOUTES LES RESSOURCES
EN LIGNE



* Compatibles pour Bench ARIAL, CONECT et ROBIN



Gustave

Silencieux

Fermeture amortie

Préhension optimale

Grande poignée
en aluminium

Réversible

Au choix : ouverture
à droite ou à gauche

Kit d'électrification

(option)

Fabriqué
en France



Surface
antibactérienne















Organisé & Astucieux



Nuancier

Mélangé
Corps, top, façade

-  **MG**
-  **N5**
-  **MA**
-  **R2**
-  **R1**
-  **R3**
-  **N6**
-  **M9**
-  **N9***
-  **MK/N9***

Accessoires



↑
Vide poche/
Jardinière



↑
Plumier



↑
Étagère



↑
Tableau magnétique

Synoptique

Towers individuels

Tower bas

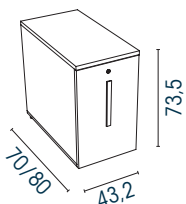

Tower haut

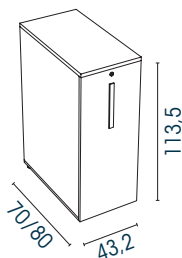

Tower partagé

Ouverture double accès avec espace sécurisé de chaque côté

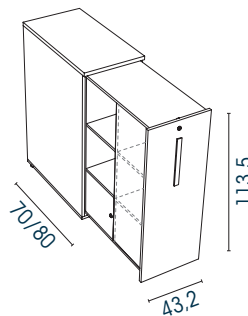

* MK/N9 : Top des meubles en Noir velours MK / Corps et façades en Noir N9 (Towers H. 73.5 cm uniquement)

* N9 : Towers H. 113.5 cm uniquement

TARIF P. 57

Détails et disponibilités

TOUTES LES RESSOURCES EN LIGNE





Mélina

TOUJOURS À PROXIMITÉ !

Mobile, le caisson MÉLINA se glisse sous le bureau même le plus compact grâce à sa version faible encombrement. En version retour ou extension, il optimise la surface de travail et offre un rangement accessible et sécurisé.

Fabriqué
en France



Surface
antibactérienne





Conçu en mélamine, MÉLINA s'harmonise avec le décor bois du plateau ou joue les contrastes de couleurs selon les envies. En plus, 3 finitions de poignée au choix.



Nuancier

Mélamine

Corps, top, façades



MG



N5



MA



R2



RI



R3



N6



M9



N9*



MK/N9*

* MK/N9 : Top des meubles en Noir velours MK / Corps et façades en Noir N9 (Caissons H.73,5 cm uniquement)

* N9 : Caissons mobiles uniquement

Métal

Poignée



SO



SB



SG

TARIF P. 58

Détails et disponibilités

TOUTES LES RESSOURCES
EN LIGNE



Pratique & organisé

Compact Faible encombrement

L. 32 cm



Mobile L. 42 cm

4 roulettes
(dont 2 avec freins)



Hauteur bureau

Caisson retour P. 60
ou extension P. 80 cm



Accessible
Tiroir DS* à
extraction totale

Organisé
Plumier intégré

Silencieux
Fermeture amortie

Sécurité
Ouverture sélective
des tiroirs, 5^{ème} roulette
anti-basculement

Zoom



POIGNÉE

En métal
3 couleurs
au choix

Option



Coussin d'assise

Fixation velcro
Ép. 30 mm

* Dossiers suspendus



CAISSONS MELAMINE ECO



←
L. 43,6 x H. 59,1 x P. 56 cm
2 tiroirs dont 1 DS*
3 tiroirs

Caissons mobiles
(top ép. 19 mm)
Caissons hauteur bureau
(top ép. 25 mm)

.....
Ouverture sélective des tiroirs

.....
Tiroir DS* anti-basculement

.....
Plumier intégré

.....
Selon modèle, roulettes ø 40 mm
ou vérins de réglage



➤
L. 43,2 x H. 73,5
x P. 60 / 80 cm
3 tiroirs dont 1 DS*

Nuancier

Mélamine
Corps, top, façades



MG **MA**



RI

Métal
Poignée



SB **SG**

TARIF P. 59
Détails et disponibilités

**TOUTES LES RESSOURCES
EN LIGNE**



RÉHAUSSE



Réhausse avec fond pour caissons
et towers

.....
Rangement immédiatement
accessible

⤴
P. 80 x L. 43,2 x H. 40 cm

Mélamine
Corps



MG **N5**



MA **R2**



RI **R3**

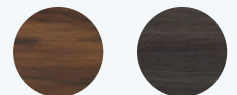

N6 **M9**

Fabriqué
en France



Surface
antibactérienne





Caissons métal

Bureaux CONECT, p.100 - Panneaux écrans
TWINS, p. 122 - Chaises OSCAR, p. 220

UN RANGEMENT ACCESSIBLE, EFFICACE ET SÉCURISÉ.

En version mobile ou à hauteur du bureau, le caisson métal optimise la surface de travail et offre un rangement accessible, efficace et sécurisé. Il apporte une touche contemporaine à l'espace grâce à ses lignes droites et épurées. Conçus en métal, ces caissons se distinguent par leur structure robuste et des finitions soignées : roulettes masquées, prise de main intégrée à la façade, top de finition.





Pratique & robuste

Compact
Faible encombrement
L. 32 cm



Mobile
avec roulettes
masquées



Hauteur bureau
Caisson retour P. 60 ou
extension P. 80 cm



Accessible
Façades avec
préhension latérale
Tiroir DS* à extraction
totale

Organisé
Plumier intégré
Accessoires
en option

Silencieux
Fermeture amortie

Sécurité
Ouverture sélective
des tiroirs, 5ème roulette
anti basculement

Nuancier

Métal
Corps, top, façades



Mélangine
Tops

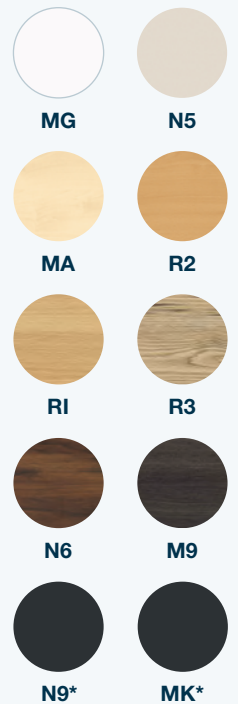

* N9 : Top des caissons
mobiles uniquement

* MK Noir velours :
Top des caissons
H73.5cm uniquement

Options



Poubelle 9L
Fixation magnétique

*Dossiers suspendus

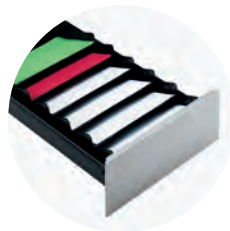

Lot de 3 séparateurs
Verticaux ou obliques



Coussin d'assise
Ep. 25 mm (fixation sur
top métal par bandes
aimantées)

TARIF P. 60

Détails et disponibilités

**TOUTES LES RESSOURCES
EN LIGNE**





Camille

RANGEMENT PERSONNEL POUR POPULATION NOMADE

CAMILLE simplifie l'arrivée des visiteurs et collaborateurs dans l'entreprise en leur offrant un espace de rangement individuel et sécurisé.

Fabriqué
en France





Disponibles en version porte simple ou double, avec ou sans fente courrier, les casiers CAMILLE permettent de ranger casques moto ou vélo, valise cabine en plus des effets personnels. Au choix, serrure à clé ou à code, porte mélamine ou métal.



Sécurisé & personnalisable



Choix des matières

Portes métal
ou mélamine

Choix des portes

- Simple adaptée à un casque moto
- Double adaptée au format valise cabine

Silencieux

Fermeture amortie

Ventilé

Dos perforé

[] 2 types de serrure



Serrure à clé

Pour portes mélamine



Serrure à code

Pour portes métal
ou mélamine



Synoptique

Corps (livrés montés)

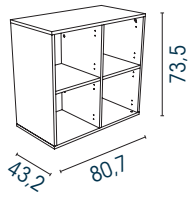

4 cases

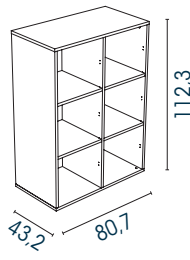

6 cases

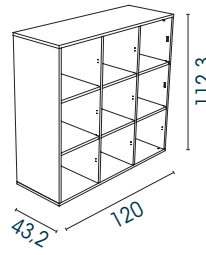

9 cases

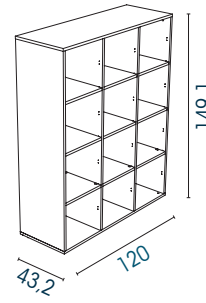

12 cases

Portes (avec ou sans fente courrier)

Métal (serrure à code)

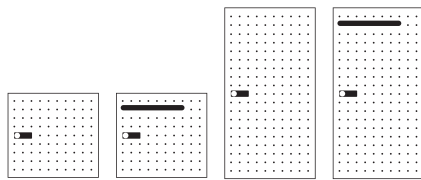

Portes simples

Portes doubles

Mélamine (serrure à clé ou à code)

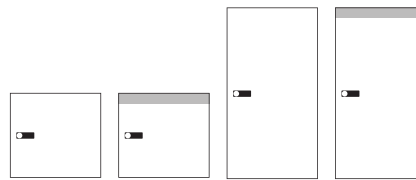

Portes simples

Portes doubles

Porte simple pour 1 case. Dim. utiles : L. 37,4 x H. 34,9 x P. 39 cm

Porte double pour 2 cases. Dim. utiles : L. 37,4 x H. 71,5 x P. 39 cm (En option : tablette complémentaire)

Options



4 pieds carrés ABS
H. 5 cm



Socle métal
H. 20 cm



Support courrier
avec porte étiquette
À suspendre au dos
de la porte mélamine



Nuancier

Mélamine Corps, portes



MG



N5



MA



R2



RI



R3



N6

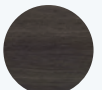

M9



N9

Métal

Portes, socle,
support courrier

SO



SA



SC



SG

TARIF P. 62

Détails et disponibilités

TOUTES LES RESSOURCES
EN LIGNE



Armand

DES RANGEMENTS ADAPTÉS À TOUS LES BESOINS

Avec ses finitions bois et sa multitude de possibilités, ARMAND structure et aménage les espaces de travail en y apportant une touche habitat.

Fabriqué
en France



Surface
antibactérienne





Disponible en version armoire, bibliothèque ou penderie, avec portes battantes ou coulissantes, ARMAND offre une solution adaptée à chaque besoin de rangement. En plus, 3 couleurs de poignée au choix.



Fonctionnel & varié



Choix des ouvertures

- Avec ou sans porte
- Coulissante ou battante
- En verre ou en mélamine

Silencieux

Fermeture amortie

Sécurisé

Porte mélamine avec serrure à clé

Réglage des vérins

par l'intérieur du meuble

Zooms



Rail

Pour portes coulissantes



Charnières silencieuses

Auto-freinées

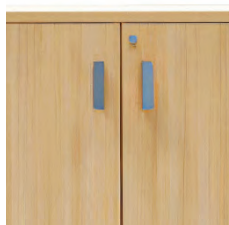

Poignées métal

Pour portes battantes
3 couleurs au choix



Poignées métal

À préhension latérale pour
portes coulissantes
3 couleurs au choix



Synoptique

Armoires portes battantes

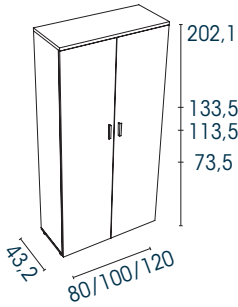

2 portes mélamine

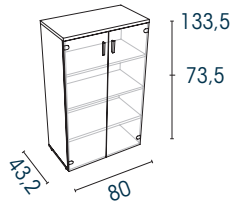

2 portes verre



4 portes mélamine ou verre
2 portes mélamine / 2 portes verre

Armoires portes coulissantes

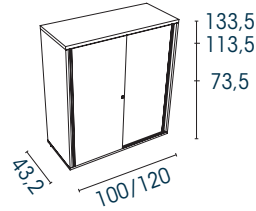

2 portes mélamine

Bibliothèques

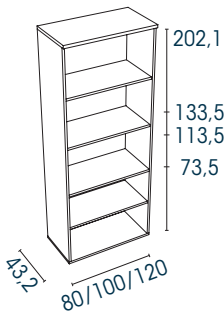

Ouverte

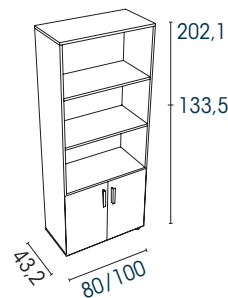

2 portes mélamine

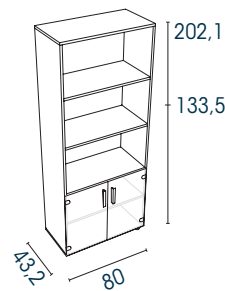

2 portes verre

Penderie

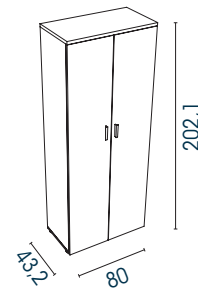

2 portes mélamine
(2/3 penderie 1/3 tablettes)

Meuble séparateur**

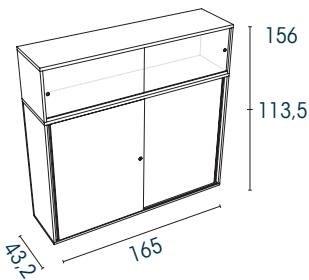

2 portes coulissantes mélamine
Réhausse 2 portes Altuglas®

Meuble bas**

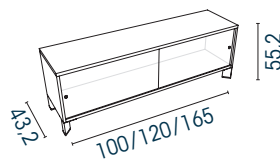

2 portes coulissantes
Altuglas®

Classeur à tiroirs**

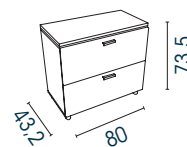

2 tiroirs pour dossiers
suspendus

Nuancier

Mélamine

Corps, top, façades

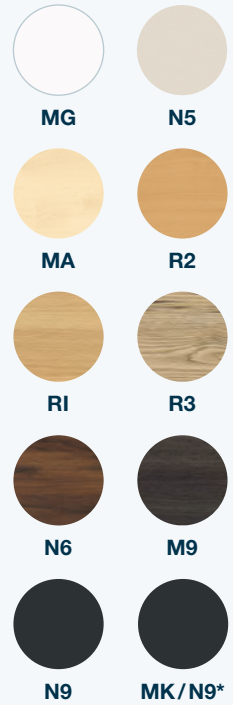

* MK Noir velours : Top des armoires et bibliothèques H. 73,5 cm uniquement. Corps et façades en Noir N9

Métal

Poignées



Verre

Façades



Altuglas®

Façades



TARIF P. 63

Détails et disponibilités

TOUTES LES RESSOURCES
EN LIGNE



En option : dessus de finition, tablettes mélamine ou métallique

** Non disponible en coloris noir



Ariv

+ Esthétique & soignée



Fermeture aimantée



Non feu
Rideaux PVC M1

Harmonie des finitions

Lame terminale et tablettes assorties à la couleur du coffre

Visibilité et accès immédiat aux dossiers

Ouverture totale des rideaux

Jusqu'à 5 niveaux de classement

Un rail en partie haute permet d'accueillir les dossiers suspendus (sauf H.72,1 cm et rehausse)

[] Zooms



Réglage des vérins par l'intérieur



Ouverture facilitée
Poignées rectangulaires encastrées





Accessoires



Classer

- Classement à plat ou pour dossiers suspendus (tablette métallique avec système de rail)
- Classement vertical optimisé grâce à des séparateurs verticaux H. 19 cm
- Trieur 16 cases format A4 L. 104 x P. 33 x H. 32 cm (à poser sur une tablette L.120 cm)
- Accès facilité aux dossiers suspendus grâce à l'option châssis télescopique (avec système d'ouverture sélective)
- Possibilité de consulter les dossiers suspendus de face grâce à des traverses et arceaux anti débordements (Incompatible avec armoire L. 80 x H. 72,1 cm)

Consulter

Tablette de consultation télescopique à extraction totale

Installer rapidement

Repères de positionnement des tablettes et châssis télescopiques (pas de 20 mm)

Nuancier

Métal

Corps



SO



SD



SB



SC



SG

PVC

Rideaux



SO



SG



SC



SD



SB



MA



RI

Au choix, armoire unicolore ou bicolore cf. tarif

Top mélaminé ép. 25 mm assorti au bureaux



Synoptique

Armoires hautes

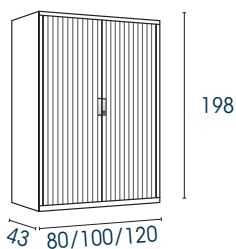

Armoires intermédiaires

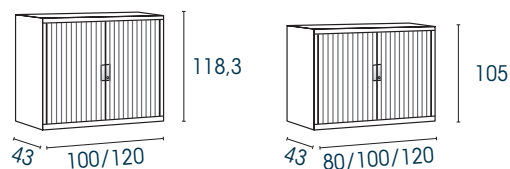
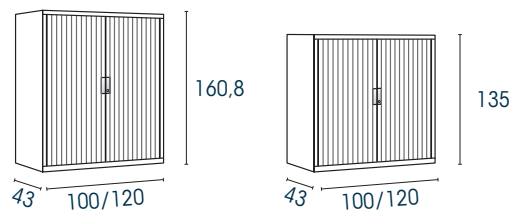

Armoires hauteur plan de travail

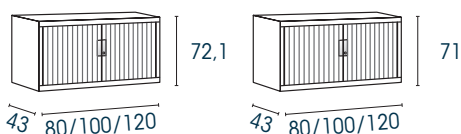

Réhauses

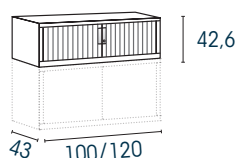

TARIF P. 66

Détails et disponibilités

TOUTES LES RESSOURCES
EN LIGNE





Navert

+ Fiable & robuste



Non feu
Rideaux PVC M1



Harmonie des finitions

Lame terminale assortie à la couleur du coffre
Tablettes blanches pour coffre blanc
Tablettes noires pour les autres finitions

Fond plat

Pour une extraction facilitée des dossiers en bas de l'armoire

Jusqu'à 5 niveaux de classement

Une tablette encastrée en partie haute permet d'accueillir les dossiers suspendus

Zooms



Réglage des vérins par l'intérieur



Ouverture facilitée
Poignées arrondies encastrées

Fabriqué
en France





Accessoires



Classer

- Classement à plat ou pour dossiers suspendus (tablettes métalliques avec système de rail)
- Classement vertical optimisé grâce à des séparateurs verticaux H. 18 cm
- Accès facilité aux dossiers suspendus grâce à l'option châssis télescopique (avec système d'ouverture sélective)

Consulter

Tablette de consultation télescopique à extraction totale

Installer rapidement

Repères de positionnement des tablettes et châssis télescopiques (pas de 25 mm)

Synoptique

Armoires hautes

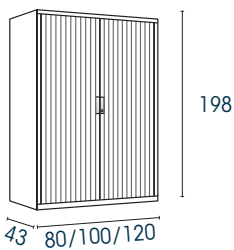

Armoires intermédiaires

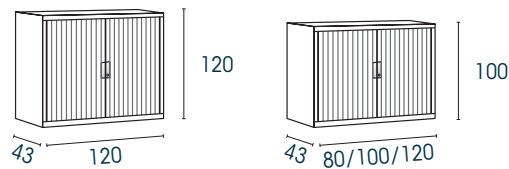
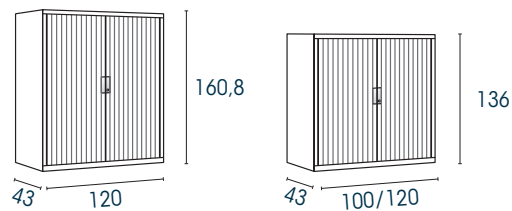

Armoires hauteur plan de travail

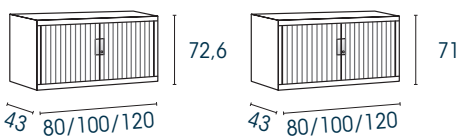

Rehausses

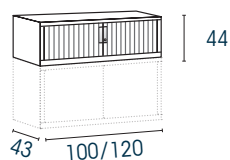

Nuancier

Métal

Corps



SO

SD



SB

SC



SG

PVC

Rideaux



SO

SG



SC

SD



SB

MA



R2

R1

Top mélaminé ép. 25 mm assorti au bureaux

Au choix armoire unicolore ou bicolore (cf. tarif)

TARIF P. 67

Détails et disponibilités

TOUTES LES RESSOURCES
EN LIGNE





Armoires démontables

+ Pour accès difficiles



Non feu
Rideaux PVC M1

Fermeture aimantée & sécurisée
Lame terminale, serrure 2 points

Classement à plat ou pour dossiers suspendus

Jusqu'à 5 niveaux de classement
Un rail en partie haute permet d'accueillir les dossiers suspendus

Nuancier

Métal & PVC



SDSD
Gris clair



SCSC
Gris anthracite

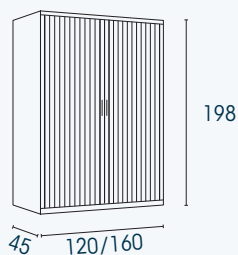

TARIF P. 68

Détails et disponibilités

TOUTES LES RESSOURCES EN LIGNE



Classeurs dossiers suspendus



Serrure centralisée
(clé passe sur demande)

Ouverture sélective
des tiroirs et système de sécurité
anti-basculement

Poignées ergonomiques
et **porte-étiquettes** intégrés

Glissières télescopiques à billes
avec aspiration en fin de course

Tiroirs pour dossiers suspendus
format A4

En option : fond cranté pouvant
recevoir des intercalaires

3 hauteurs : 71,1/101,6/132,4 cm
(L. 41,3 x P. 62,2)

Nuancier

Métal

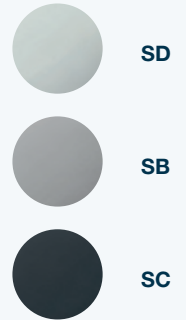

TARIF P. 68

Détails et disponibilités

**TOUTES LES RESSOURCES
EN LIGNE**



Classeurs à tiroirs



Poignées PVC avec
porte-étiquettes intégrés
(étiquettes non fournies)

Serrure tous les 2 tiroirs

Glissières à billes
extraction 80 %

Tiroirs pour dossiers suspendus
format A4

2 hauteurs : 67,2/128,2 cm
(L. 41,3 x P. 40)

Nuancier

Métal

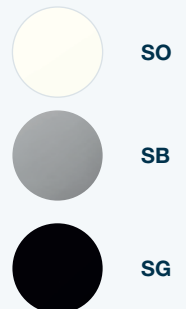

TARIF P. 68

Détails et disponibilités

**TOUTES LES RESSOURCES
EN LIGNE**





Rayonnages tubulaires

+ Simple & robuste



Montage rapide et sans outils

Par simple emboîtement

Montants profilés en «T»

Acier ép. 7/10ème

Tablette composée de 3 ou 4 traverses

En acier galvanisé
200 kg max. par traverse

Dessus Isorel

Optionnel

Nuancier

Métal

Montants peints



SC

Métal

Montants galvanisés



ZJ

Départ



100/125

Suivant



100/125

P: 35/50/70

Fabriqué
en France



TARIF P. 69

Détails et disponibilités

TOUTES LES RESSOURCES
EN LIGNE





Rayonnages polyvalents

+ Rangement optimisé & accessible



Stable

Fond croisé

Montants 35 x 35 mm

Tablettes métalliques pleines

120 kg max

Par tablette

Classement à plat ou pour dossiers suspendus

Tablette métallique avec système de rail

Nuancier

Métal

Montants peints et tablette



SC / SD
Peint



ZJ / ZJ
Galvanisé

Départ

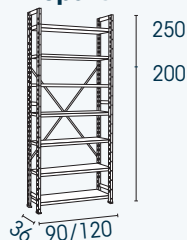

Suivant

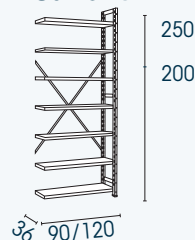

Fabriqué
en France



TARIF P. 70

Détails et disponibilités

TOUTES LES RESSOURCES
EN LIGNE





Nuancier

Métal

Corps et portes



SDSSD
Gris/gris



SDSK
Gris/bleu

TARIF P. 71

Détails et disponibilités

TOUTES LES RESSOURCES
EN LIGNE



Vestiaires industriels



Industrie propre



Industrie salissante

Vestiaires monoblocs et démontables

Vestiaires équipés d'une tablette avec triangle porte-cintres

Porte-étiquette embouti (étiquette non fournie)

Ventilation

en partie haute, basse et à l'arrière

Fermeture par morailion

porte-cadenas (cadenas non fourni)

Séparation médiane

pour protéger les vêtements de ville (vestiaires industrie salissante uniquement)

Métal

Corps et portes



SDSK
Gris/bleu



SDQK
Gris/rouge

TARIF P. 71

Détails et disponibilités

TOUTES LES RESSOURCES
EN LIGNE



Vestiaires multicases



Vestiaires démontables

Tringle et porte-cintres

Aération

En partie haute et à l'arrière

Tablettes anti-effraction

Entre 2 cases superposées

Fermeture par morailion

porte-cadenas (cadenas non fourni)





[] Options



Toits en pente

H. 13 x P. 50 cm

Existe en largeur 60/80/90 ou 120 cm

Pour vestiaires monoblocs et démontables



Socles pieds

H. 15 x P. 50 cm

Existe en largeur 60/80/90 ou 120 cm

Pour vestiaires démontables



Socles bancs

H. 25 x P. 80 cm

Existe en largeur 60/80/90 ou 120 cm

Pour vestiaires monoblocs et démontables



Jeu de 4 pieds

H. 15 cm

Pour vestiaires monoblocs

[] Bancs indépendants



.....

Existe en L.
120/160/200 cm

.....

Piètement métal
Tube carré finition gris clair
Avec vérins de réglage

.....

Assise constituée de
3 lattes en bois
hêtre clair verni





Espaces réunion & collectivités





Espaces réunion & collectivités



Karl

SALLE DE CONSEIL

RÉUNION

Page 158 ›



Modulo

SALLE DE CONSEIL

RÉUNION

Page 164 ›



Arial

BRAINSTORMING

RESTAURATION

RÉUNION

Page 168 ›



Robin

BRAINSTORMING

RÉUNION

Page 174 ›



E-meeting

RÉUNION

Page 176 ›



Ping

RÉUNION

Page 178 ›



Martin

BRAINSTORMING

RÉUNION

Page 180 ›



Chatbox

RÉUNION

Page 184 ›



Tables abattantes

FORMATION

Page 188 ›





Emi

- FORMATION
- RESTAURATION
- RÉUNION

Page 192 ›



Table polyvalente

- FORMATION
- RESTAURATION
- RÉUNION

Page 190 ›



Tables à dégagement latéral

- RESTAURATION
- RÉUNION

Page 191 ›



Tables pliantes

- FORMATION
- RESTAURATION
- RÉUNION

Page 193 ›



Eloïse

- RESTAURATION
- RÉUNION

Page 194 ›



Evasion

- RESTAURATION
- RÉUNION

Page 198 ›



Clara

- RESTAURATION

Page 201 ›



Lucie

- RESTAURATION

Page 202 ›



Iris

- RESTAURATION

Page 203 ›





Karl

ÉLÉGANCE ET CARACTÈRE DES ESPACES DÉCISIONNELS

KARL se distingue par l'élégance de son dessin et la noblesse de ses matériaux. Ses lignes épurées imposent un style distinctif aux espaces conférence.

Fabriqué
en France





Disponible en version linoléum ou mélamine noir velours, KARL se caractérise par la résistance et la texture douce de ses plateaux. Pour petits ou grands espaces, ces tables peuvent équiper des salles de conférence jusqu'à 20 personnes.



Zoom



Pied électrifié

Accès aux câbles par un cache en bois à visser (version plateau avec trappe)

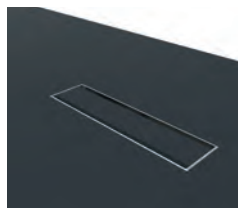

Trappe soft closing double accès

Assortie à la couleur du plateau



Élégant & Noble

Élégance des espaces

Des formes douces alliées
à des matières nobles
(pieds en chêne massif)

Textures douces et uniques

Au choix,

- Toucher velours et haute résistance avec la mélamine noire MK
- Toucher doux et surface mate avec le plateau en Linoléum (cf. plus de nuance p. 285)

Des tables pour petits ou grands espaces

Carrées ou rectangulaires
De 6 à 20 personnes

Électrification discrète

Passage de câbles intégré au pied
Couleur des trappes assortie au plateau

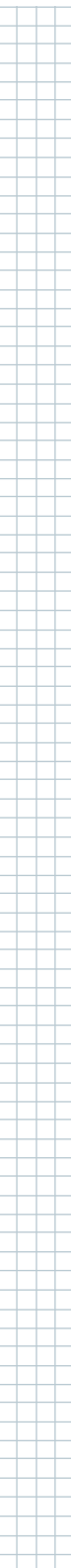



Composer KARL



Exemples de configuration



Le style par l'assise

.....
Avec les chauffeuses BIP pour un effet enveloppant et chaleureux



.....
Avec les chaises SCOTT pour un effet très contemporain



Synoptique

Tables rectangulaires

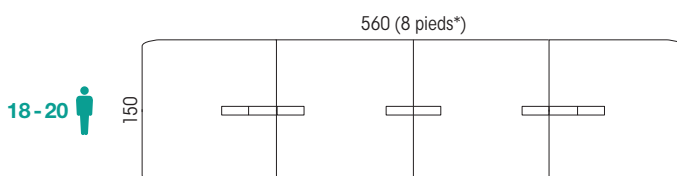
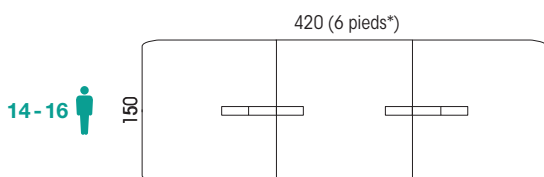
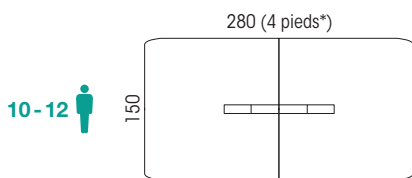

Tables carrées

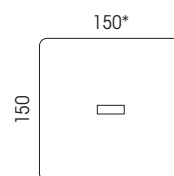
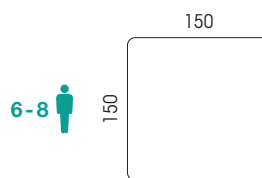

KARL existe aussi en version
Bureaux de direction p. 60

* Pour les plateaux avec trappe :
Tables L. 150/280/420 cm avec 1 pied électrifié
Table L. 560 cm avec 2 pieds électrifiés



Diriger / se réunir

Une table carrée, pour compléter un bureau
ou équiper un petit espace

Nuancier

Mélamine

Plateaux ép. 25 mm



N5



MK
Mélamine
noir velours

Linoléum

Plateaux ép. 20,6 mm



LU

Bois

Piètement



CM

Métal

Structure tables



ZP



ZC

TARIF P. 74

Détails et disponibilités

TOUTES LES RESSOURCES
EN LIGNE





Modulo

LA RÉUNION MODULAIRE ET CONNECTÉE

Particulièrement adapté à l'aménagement des salles de conférences ou des grands espaces de réunion, MODULO offre de multiples configurations de tables ouvertes ou fermées. Son kit extension permet d'ajuster à l'envi la dimension des tables.

Fabriqué
en France



Surface
antibactérienne





Cette gamme intègre également des solutions de câblages esthétiques pour un espace propre et ordonné.



Composer MODULO

Synoptique

Tables ovales

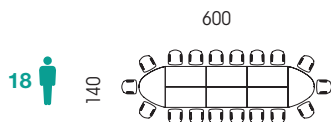
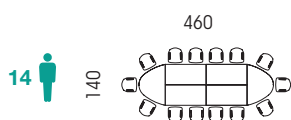
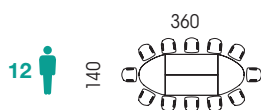
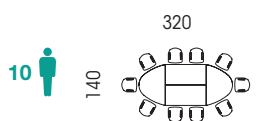

Tables elliptiques

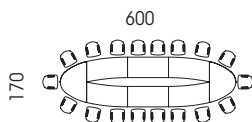
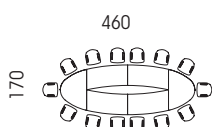
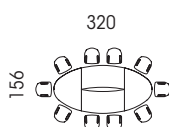

Tables U

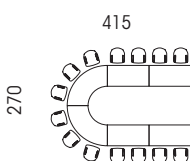
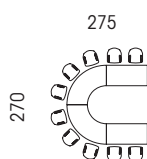
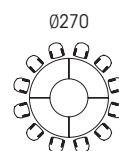

Table ronde



Kits extension



L. 140 cm
Pour 2 ou 4 personnes

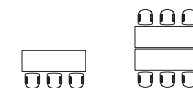

L. 180 cm
Pour 3 ou 6 personnes

Connectique

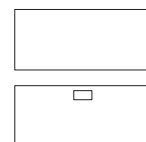

* Vous souhaitez une configuration spécifique ?
Consultez votre responsable commercial

3 types de piétements



Piètement panneaux
(Mélaminé)



Piètement rond
(Métal)



Piètement carré
(Métal)



Composé ou à composer, une infinité de possibilités



Nuancier

Mélamine

Plateaux ép. 38 mm,
piétement



RI



N6



M9

Plateaux ép. 30 mm,
piétement



MG



RI

Métal

Piétement



SO



SA

Choix des plateaux

Mélamine ép 30 ou 38 mm,
4 formes différentes
(rectangulaire, cintrée,
elliptique ou angle)

Variété des configurations

- Forme ovale, elliptique, ronde ou en U
- De 10 à 18 personnes ou plus en personnalisant votre configuration*

Choix de l'électrification

Plateaux nus pour une connectique nomade ou pré-perçés pour trappe avec goulotte intégrée

TARIF P. 75

Détails et disponibilités

TOUTES LES RESSOURCES
EN LIGNE





Arial

RENDRE L'ESPACE AGILE

Pour les espaces de formation ou de réunion, fixe ou mobile, en version haute ou standard, ARIAL réunion offre de multiples solutions d'aménagement.

Fabriqué
en France





Sa version mobile apporte de l'agilité aux environnements de travail. Elle permet aux collaborateurs de reconfigurer l'espace selon leurs usages sans changer de pièce.



2 types de piétements



Arche

H. 73,5 ou 104,5 cm



Arche mobile

H. 73,5 ou 104,5 cm



Simple & agile



Hauteur standard
H. 73,5 cm



Tables hautes
H. 104,5 cm



Choix des configurations

Forme carrée ou rectangulaire
De 2 à 16 personnes

Diversité des usages

Des tables faible profondeur idéales
pour les espaces formation ou
les espaces d'attente

Ergonomie & stabilité

Tables hautes avec repose-pieds pour un confort optimal
Câbles de tension pour plus de stabilité

Électrification variée

Obturbateurs avec connexion directe
ou trappe centrale double accès



Composer ARIAL

Une journée avec Arial mobile !



Se concentrer

Moment calme

L'équipe s'installe pour travailler individuellement. Les cloisons Solange séparent visuellement les collaborateurs, chacun peut se concentrer



Brainstormer

En mode projet

L'équipe transforme l'espace pour se réunir, brainstormer, échanger, décider. Le tableau mobile Martin, permet de rester connecté avec les collaborateurs qui travaillent en distanciel



Synoptique

Tables rectangulaires

H. 73,5 et 104,5 cm

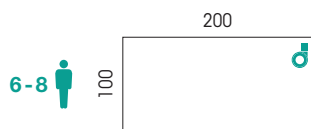
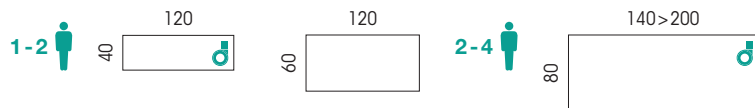

Existe en version mobile

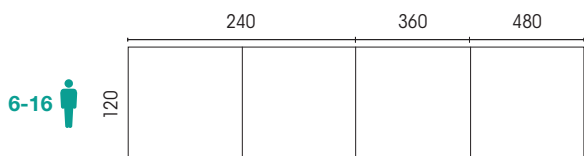

ARIAL existe aussi en version Bureaux p. 106

Tables carrées

H. 73,5 et 104,5 cm

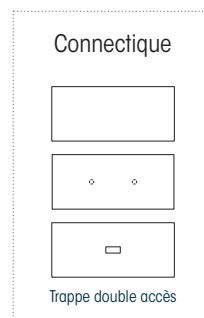
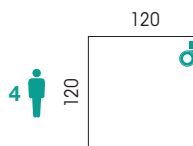
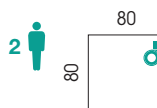

Nuancier

Mélanges

Plateaux ép. 25 mm

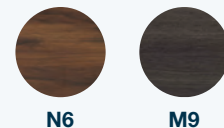
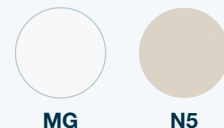

Métal

Piètement



Se détendre

Esprit d'équipe

Ajouter une table PING à l'espace pour activer l'esprit sportif de ses collaborateurs et créer un lien collectif

TARIF P. 80

Détails et disponibilités

TOUTES LES RESSOURCES EN LIGNE





Robin

Table ROBIN, p. 174 - Sièges ELIOTT
p. 216 - Armoires ARMAND, p. 140

DES LIGNES DOUCES ET NATURELLES

Inspiré des codes de l'habitat, ROBIN se distingue par l'élégance de son piétement en hêtre massif. Légèrement arrondi, il apporte douceur et chaleur aux environnements de travail.

Une solution clé en main, adaptée au mode de travail hybride, pour des espaces aussi ordonnés que connectés

Fabriqué
en France



Robin existe aussi en version Bureaux p. 96



Tendance & Fonctionnel

Hauteur standard
H. 73,5 cm



Tables hautes
H. 104,5 cm



Électrification variée

Obturbateurs avec connexion directe ou trappe centrale double accès

Confortable

Repose-pieds avec câbles de tension pour une stabilité optimale

Nuancier

Mélamine

Plateaux ép. 25 mm



MG



N5



RI



MK
Mélamine
noir velours

Métal

Piètement (repose-pieds, platine)



SO



SG

Bois massif

Piètement



MS

Synoptique

Tables rectangulaires

H. 73,5 et 104,5 cm

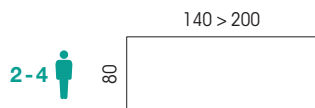

Tables carrées

H. 73,5 et 104,5 cm

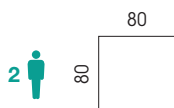
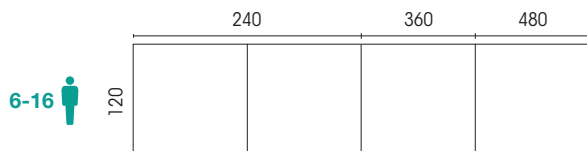
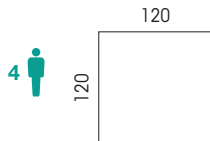
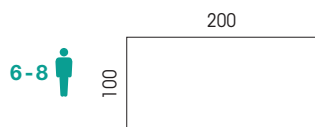
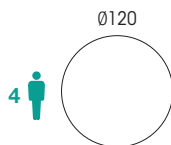
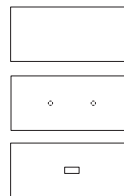

Table ronde

H. 73,5 et 104,5 cm



Connectique



Trappe double accès

TARIF P. 83

Détails et disponibilités

TOUTES LES RESSOURCES EN LIGNE





E-meeting

LA RÉUNION CONNECTÉE

Répondant aux nouveaux modes de travail, E-MEETING offre une solution complète pour réaliser vos présentations ou visioconférences. Son mur multimédia intègre l'électrification et permet de positionner un écran sans câbles apparents. Sa table avec trappe permet une connexion discrète et confortable. Une solution clé en main adaptée, au mode de travail hybride, pour des espaces aussi ordonnés que connectés

Fabriqué
en France



Surface
antibactérienne





Moderne & Connectée

Mur multimédia

Pour écran TV ou bras support écran
Passage de câbles intégrés



Nuancier

Mélamine

Plateaux ép. 38 mm
Mur multimédia
ép. 19 mm



MG



RI

Métal

Pied corolle, cadre mur
multimédia



SO



SA



SG

Choix des postures

Des versions hautes (H. 105 cm)
ou H. 73,5 cm

Goulotte métal incluse

Couleur assortie au piétement
ou au cadre du mur multimédia

Synoptique

Plateau arrondi

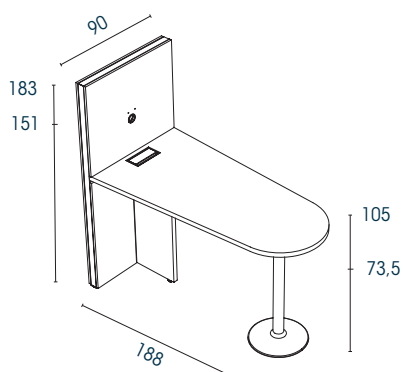

(Pied corolle)

Plateau trapèze

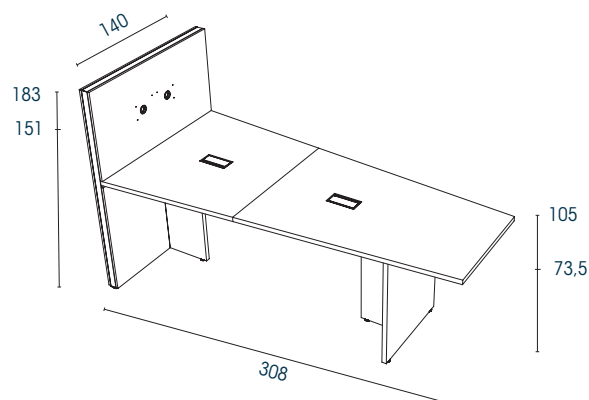

(Piétement panneau)

TARIF P. 85

Détails et disponibilités

**TOUTES LES RESSOURCES
EN LIGNE**





Ping

LA TABLE DE RÉUNION QUI CULTIVE L'ESPRIT SPORTIF

Sérieuse et ludique à la fois, la table PING transforme les moments de réunion en tournoi sportif ! Réunissant jusqu'à 6 personnes, elle se transforme en un clin d'œil en table de jeu grâce à son kit de ping pong. Ses finitions douces apportent aux espaces collectifs un style moderne et chaleureux.

Fabriqué
en France





Travail & Détente

Transformation rapide

Filet extensible avec montants ajustables selon l'épaisseur du plateau



Kit Ping-Pong inclus

(1 filet, 2 raquettes et 2 balles)



Résistant

Aux chocs et aux rayures
(Plateau mélaminé)

Tonalités douces et naturelles

Pour créer une atmosphère propice à la détente et aux échanges
(Pieds en hêtre massif)

[] Option



Tiroir pour ranger le kit de ping-pong
(option)

Nuancier

Mélamine

Plateau ép. 25 mm



M7*

* Chants coloris blanc

Métal/Bois massif

Piètement



ZOMS

TARIF P. 86

Détails et disponibilités

TOUTES LES RESSOURCES
EN LIGNE





Martin

L'ALLIÉ DES ESPACES AGILES

Pour brainstormer, partager ses idées, assister à une présentation, MARTIN est à l'aise en toute situation. A la fois mur multimédia, tableau blanc et espace de rangement, Il suffit de choisir son côté pour changer d'usage.

Fabriqué
en France





Mobile, il se déplace facilement. Connecté, il intègre de manière discrète câbles et prises pour un espace ordonné. Une construction intelligente qui transforme n'importe quel espace en espace agile.



Mobile & Connecté

2 faces
avec rangements



1 face
multimédia



2 faces
avec poufs ZÉLIE



Mobile

Il se déplace à volonté
4 roulettes dont 2 avec freins
(tous types de sols)
Préhension par les montants

Connecté

- Support écran intégré jusqu'à 55 pouces.
- Connexion directe via le passe-câble ou la prise intégrée au panneau frontal (1PC)
- Électrification discrète et accessible grâce aux panneaux arrières amovibles

Tableau blanc magnétique

Effaçable à sec, avec bande magnétique sur le haut
(Panneau mélamine recouvert d'un film Veleda)

[] Zooms



Tableau blanc
avec auget intégré



Sangle clipsable
Pour rangement des poufs ZÉLIE



Synoptique

Tableau 1 face

Multimédia



Tableau 2 faces

Avec rangement fermé

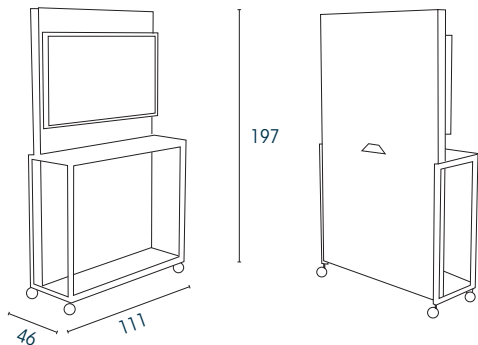
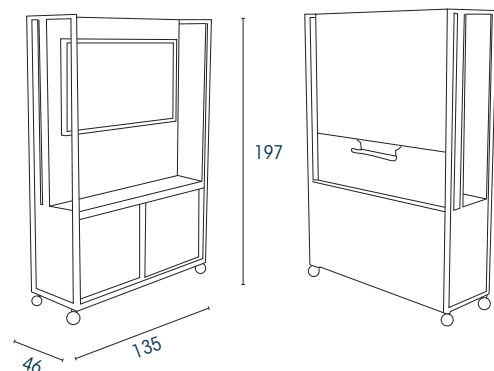

Recto : Multimédia + rangement
(2 portes coulissantes)
Verso : tableau blanc

Avec espace ouvert

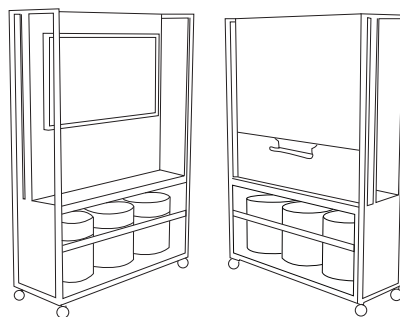

Recto : Multimédia + espace ouvert
(pouf ZELIE en option)
Verso : tableau blanc

Nuancier

Mélamine

Panneaux ép. 19 mm,
rangement et tablettes



MG



MK

Panneau central



RI



R3



N6

Métal

Structure, auget



ZO



ZP



Enrouleur de câbles

Des 2 côtés

TARIF P. 86

Détails et disponibilités

TOUTES LES RESSOURCES
EN LIGNE





Chatbox

PLUS QU'UNE CABINE...UN CONCENTRÉ D'EFFICACITÉ !

CHATBOX est l'alternative aux salles de réunions classiques. Positionnées au cœur de l'espace collectif, peu encombrantes, ces cabines offrent aux collaborateurs un îlot confidentiel pour se concentrer, se réunir ou simplement téléphoner sans déranger les autres. Une solution innovante pour des espaces collectifs optimisés, plus sereins et productifs.





Acoustique & Connectée

Ventilation efficace et silencieuse

Du plafond vers le sol



Porte réversible

Ouverture droite ou gauche (à choisir à l'installation)
Fermeture magnétique



Connectée

Électrification intégrée
(prise de courant fort
+ ports USB-A et USB-C)

Éclairage Led

avec détecteur de présence

Décorative

Panneaux latéraux métalliques
blanc ou noir (fixation aimantée)





↑
Tabouret TOM, p.224

Composer Chatbox



TELEPHONER

Ajouter un tabouret TOM pour offrir une assise active, le temps d'un échange téléphonique.



SE CONCENTRER

S'isoler pour mieux se concentrer au sein de l'espace collectif. La version avec pied RH* électrique permet de travailler assis ou debout



Synoptique

Cabines

CB1



1 Avec tablette

CB2

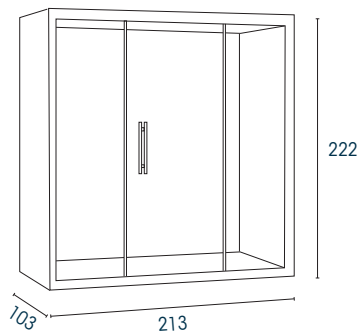

1-4 Nue
Avec table centrale / pied fixe
Avec table latérale / pied RH* électrique

CB4

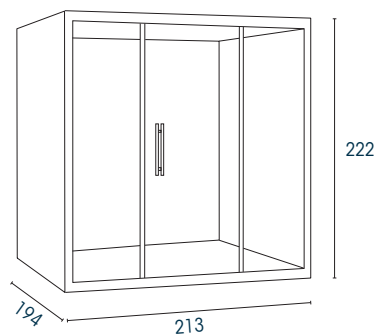

4-6 Nue
Avec table centrale / pied fixe

Options



Banquette 2 places



Table centrale



Support écran



SE REUNIR

A 2, 4 ou 6 personnes, avec connectique intégrée pour ne pas perdre le fil !

Nuancier

Métal

Panneaux latéraux,
Piétement table et
chauffeuse



SO



SG

Tissu

Banquettes



FU
Gris foncé

TARIF P. 87

Détails et disponibilités

TOUTES LES RESSOURCES
EN LIGNE





Tables abattantes

Synoptique

Plateaux droits

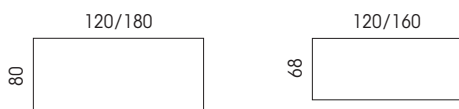

Extensions demi-lune

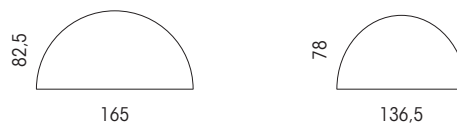

Fabriqué
en France





Simple & Maniables

Multi-espace

Idéal pour les espaces de réunion ou formation

Reconfigurable

Un système simple et rapide pour faciliter la reconfiguration des espaces formation



Voile de fond rabattable en tissu
(Option)

Mobile
4 roulettes avec freins
(tous types de sols)

Nuancier

Mélangé

Plateaux ép. 19 mm



MG



N5



MA



R2



RI



R3



N6



M9



MK

Mélangé noir velours

Métal

Piètement



SO



SA



SG

Installation simple et rapide



Basculement rapide et sécurisé



Assemblage sans outils
Par boutons moletés
(inclus)



Stockage optimisé :
Rangement par emboîtement
en position basculée

TARIF P. 88

Détails et disponibilités

TOUTES LES RESSOURCES EN LIGNE





Emi

+ Mobile & Flexible



Un style unique

Design des chaises et table assorti

Sens du détail

Piètement et roulettes chromés
Chant noir assorti au voile de fond

Stockage optimisé

Table abattante à l'horizontale

Mobile

Roulettes sol souple et dur

Nuancier

Méla mine

Plateau blanc/chant noir ép. 25 mm



MM

Métal

Piètement



SQ



Manette de basculement facile d'utilisation



Chaises EMI assorties à la table Cf. P.240

Fabriqué en France



Surface antibactérienne



TARIF P. 113

Détails et disponibilités

TOUTES LES RESSOURCES EN LIGNE





Tables polyvalentes

+ Économiques & fonctionnelles



Cadre porteur anthracite

Piètement équipé de vérins de réglage

Configuration variée

Plan droit, demi-lune ou trapèze

Nuancier

Mélangé

Plateaux ép. 19 mm



MG



N5



R2



RI

Métal

Piètement



SO



SA



SC

Fabriqué en France



Surface antibactérienne



TARIF P. 89

Détails et disponibilités

TOUTES LES RESSOURCES EN LIGNE





Nuancier

Mélamine

Plateaux ép. 25 mm



MG



N5



MA



R2



RI



R3



N6



M9



MK

Mélamine
noir velours

Métal

Piètement



SA

Tables à dégagement latéral

+ Légères & Modulaires



Piètement à dégagement latéral

Facilite le passage des chaises
ou des jambes

Table ronde, carrée ou rectangulaire

H. 73,5 cm

Synoptique

Tables rectangulaires

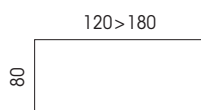
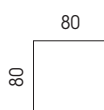
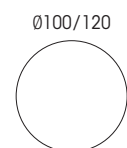

Table carré



Tables rondes



Angle 90°

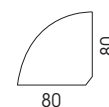

TARIF P. 90

Détails et disponibilités

TOUTES LES RESSOURCES
EN LIGNE



Fabriqué
en France



Surface
antibactérienne





Tables pliantes

+ Un rangement facilité



Modulaires

Tables rectangulaires et 1/2 lune
H. 72 cm

Chant assorti au plateau

Fabriqué
en France



Surface
antibactérienne



Nuancier

Mélanine

Plateaux ép. 25 mm



MG



N5



R2



RI

Métal

Piètement



SQ



Individuelles

Tables rectangulaires

Double barre de renfort
en acier sous le plateau

Mélanine

Plateaux ép. 18 mm



GR

Gris clair

Métal

Piètement



SG



Option : Chariot

Idéal pour le transport et le stockage

Capacité :
10 tables pliantes,
20 chaises collectivité 4 pieds
ou 14 chaises pliantes

Sangle incluse pour le maintien
des chaises pliantes



TARIF P. 91

Détails et disponibilités

TOUTES LES RESSOURCES
EN LIGNE





Eloise

SE RESTAURER, SE RÉUNIR DE TOUTES LES FAÇONS !

Idéales pour aménager vos espaces de réunion et/ou de restauration, les tables individuelles ELOISE vous offrent un large choix de types de piétements et de plateaux.

Fabriqué
en France





Alliant praticité et robustesse, cette gamme sera capable de répondre à tous vos besoins d'aménagement. ELOISE propose également des solutions d'électrification pour vos salles de réunion.



Synoptique

Tables rondes



Mélangé Ép. 25 ou 38 mm
Stratifié (uniquement Ø120cm)

Tables carrées

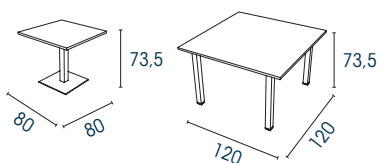

Mélangé Ép. 25 ou 38 mm
Stratifié (uniquement sur table avec pied central)

Tables tonneau

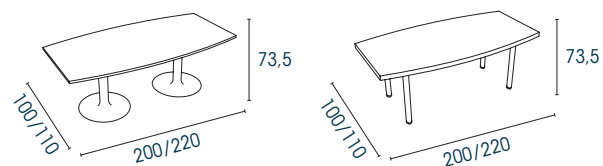

Mélangé Ép. 25 ou 38 mm

Tables rectangulaires

Mélangé ép. 38 mm

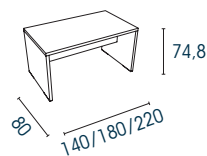
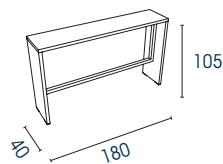
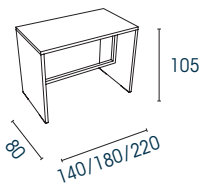
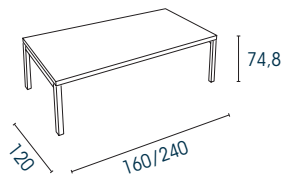

Banc

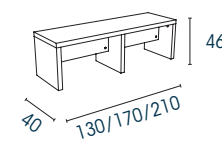

Manges debout

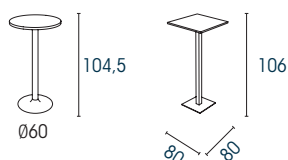

Mélangé Ép. 25 mm ou stratifié



Une table pour chaque usage !



Nuancier

Mélamine

Plateaux ép. 25 mm ou 38 mm*



MG



N5



MA



R2



RI



R3



N6



M9



MK

Mélamine noir velours

* Plateaux ép. 38 mm disponible uniquement en MG, RI, N6, M9

Stratifié

Plateaux ép. 23,6 mm



HZ



VW

Métal

Piètement



SO



SA



SC



SG

TARIF P. 92

Détails et disponibilités

TOUTES LES RESSOURCES EN LIGNE



Formes variées

- Table carrée, ronde ou rectangulaire
- Mange debout pour les pauses cafés

Choix des matières

Stratifié ou mélaminé

Choix des postures

- Des versions hautes H. 105/106 cm
- ou standard H. 73,5/74,8 cm

Multi-espaces

- Des tables adaptées autant aux espaces réunion et/ou restauration
- La console P40 permet d'aménager des espaces intermédiaires d'attente pour se restaurer ou travailler

Connectée

Table nue ou électrifiable selon les versions :

- Plateaux pré-perçés pour obturateurs
- Plateaux découpés pour trappe : tables carrées, rectangulaires et tonneaux (hors version pieds panneaux)



Evasion

POUR UN ESPACE NATUREL !

Alliance subtile du métal et du hêtre naturel, la gamme EVASION séduit grâce à ses lignes graphiques et élancées. Complète, elle propose des tables et des assises coordonnées.

Fabriqué
en France





Disponible en plusieurs formes et dimensions, EVASION s'adapte aussi bien aux espaces de restauration qu'aux espaces de réunion.



Nuancier

Stratifié

Plateaux ép. 23,6 mm



HZ



VW

Métal/Bois

Piètement



ZOMS



ZPMS

Evasion

+ Moderne & Naturelle



Style naturel

Pieds en hêtre massif

Configurations variées

Tables rondes ou rectangulaires

Varié les postures

Des versions hautes (H. 105 cm) ou H. 73,5 cm

Résistants & lavables

Plateaux stratifiés résistants aux tâches et aux rayures

Zooms



Insert métal

Blanc ou noir, assorti au plateau



Chant multiplis

Décor hêtre

TARIF P. 94

Détails et disponibilités

TOUTES LES RESSOURCES
EN LIGNE





Clara

+ Un piétement qui se joue des lignes !



Choix des matières

Stratifié

- Pour les espaces restauration (plus résistant)

Méliné

- Pour les espaces réunion

Style contemporain

Piétement constitué d'un jeu de croisement de lignes, qui apporte légèreté et style à la table

Varié les postures

Des versions hautes (H. 105 cm) ou H. 73,5 cm

Nuancier

Mélamine

Plateaux ép. 25 mm



MG



N5



MA



R2



RI



R3



N6



M9



MK

Mélamine noir velours

Stratifié

Plateaux ép. 23.6 mm



HZ



VW

Métal

Piétement



ZO



ZP



TARIF P. 94

Détails et disponibilités

TOUTES LES RESSOURCES EN LIGNE





Lucie

+ Un style épuré outdoor ou indoor



Choix des versions :

- 2 hauteurs 73,5 et 105 cm
- 1 dimension de plateau : 60 x 60 cm

Usage indoor

Piètement métal et plateau mélamine

Usage outdoor

Plateau et piètement métal, traité anticorrosion

Nuancier Indoor

Métal
Piètement



ZP

Mélamine
Plateau ép. 25 mm



MG



N5



MA



R2



RI



R3



N6



M9



MK*

Outdoor

Métal
Plateau**, piètement



ZP SG

Fabriqué
en France



* MK Mélamine noir velours ** Métal ép. 3 mm

TARIF P. 95
Détails et disponibilités
TOUTES LES RESSOURCES
EN LIGNE





Iris

+ Un produit outdoor au rangement optimisé



Choix des versions

- 2 hauteurs : 73 ou 110 cm
- 1 dimension de plateau : ø 69 cm

Résistante aux UV et à l'humidité

Plateau et piétement métal traités anticorrosion avec peinture anti UV

Rangement facilité

Table fixe ou rabattable

Nuancier

Métal

Piétement, plateau



SO



Manette de basculement facile d'utilisation

Fabriqué
en France



TARIF P. 95

Détails et disponibilités

TOUTES LES RESSOURCES
EN LIGNE







Assises





Sièges de travail



Seven

Basculant décentré

DIRECTION

Page 210 >

.....



Attitud

Synchrone ergonomique

DIRECTION

Page 211 >

.....



Elton

Basculant décentré

DIRECTION

Page 212 >

.....



Manhattan

Basculant décentré

DIRECTION

Page 213 >

.....



Harly

Basculant décentré

DIRECTION

Page 213 >

.....



Coach

Synchrone confort
ou ergonomique

ERGONOMIQUE

Page 214 >

.....



Opus

Synchrone confort,
ergonomique ou ergo +

ERGONOMIQUE

Page 215 >

.....



Eliott

Synchrone autorégulé ou latéral
Translation d'assise systématique

ERGONOMIQUE

Page 216 >

.....



Leon

Synchrone latéral ou
ergonomique

ERGONOMIQUE

Page 218 >

.....



Oscar

Synchrone autorégulé
confort ou ergonomique

ERGONOMIQUE

Page 220 ›

.....



Alter

Synchrone

OCCASIONNEL

Page 222 ›

.....



Mia

Contact
permanent

OCCASIONNEL

Page 223 ›

.....



Tom

Assise active
Pivotante à 360°

ASSIS / DEBOUT

Page 224 ›

.....



Globe XXL

Synchrone
ergonomique

GRANDE TAILLE

Page 226 ›

.....



24H Pro

Basculant
décentré

INTENSIF

Page 226 ›

.....



Polyuréthane

Réglable en hauteur
Forte résistance

TECHNIQUE

Page 227 ›

.....



Multiusage

Réglable en hauteur

Page 227 ›

.....



85%

des maladies professionnelles déclarées en 2010 concernaient des TMS et des lombalgies.

Comment bien régler son siège de travail ?

A chaque morphologie, son assise. Pour s'adapter aux spécificités de chacun, il est important de personnaliser son siège de travail. Une assise bien réglée, soulage les tensions musculaires, évite les troubles musculo-squelettiques et les problèmes de dos.

Confort de l'assise

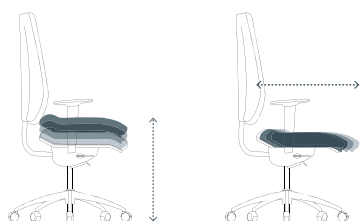

Réglage de la hauteur et profondeur de l'assise

Confort du dos

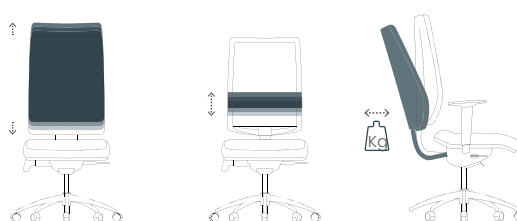

Réglage de la hauteur du dossier et/ou du soutien lombaire
Inclinaison et ajustement de la tension du dossier



Choisissez votre mécanisme EOL



Contact permanent

Système d'articulation du dossier, indépendant de l'assise

Le dossier du siège suit les mouvements du dos pour rester en « contact permanent » avec lui, tandis que l'assise reste fixe.



Basculant

Système de bascule synchrone de l'assise et du dossier vers l'arrière selon un angle constant. Il existe 2 types de mécanisme basculant :

1 - Basculant centré : point de rotation au centre de l'assise

2 - Basculant décentré : point de rotation plus près de l'avant de l'assise pour un basculement plus souple



Synchrone

Système d'inclinaison synchrone du dossier et de l'assise dans un angle différencié.

Il apporte au corps une surface de contact optimal avec le siège en soutenant parfaitement colonne et bassin. Il s'agit de la solution la plus ergonomique.

Autorégulé pour un réglage automatique de la tension du dossier

Confort ou **Latéral** : sans translation d'assise, le réglage de la tension du dossier se fait grâce à une molette frontale ou latéral

Ergonomique : avec translation d'assise, le réglage de la tension du dossier se fait grâce à une manette latérale

Ergo+ : comme le mécanisme ergonomique, avec de plus grandes amplitudes et une assise négative.

Confort de la nuque



Ajouter une option tête
Selon modèle, réglage en hauteur ou inclinaison

Confort des épaules

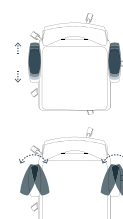
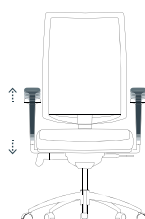

Opter pour des accoudoirs

1D : Réglage en hauteur

3D : Réglage en hauteur, largeur et profondeur

4D : l'ensemble des réglages, avec la rotation en plus



Seven

+ Statuaire & contemporain



Contemporain

Des lignes épurées
et modernes



Confort de la nuque

Tête fixe grande largeur pour un
bon maintien des cervicales

Détail des finitions

Accoudoirs fixes chromés

Nuancier

Cuir

Siège de travail



YB

Simili Cuir

Chaise



YA

Aluminium

Piètement



SQ

Chromé

Mécanisme



Basculant
décentré



TARIF P. 98

Détails et disponibilités

TOUTES LES RESSOURCES
EN LIGNE





Attitud

+ Un siège à l'allure soignée



Confort de la nuque

Tête fixe grande largeur pour un bon maintien des cervicales

Confort du dos

Dossier réglable en hauteur (+ 6 cm)

Confort de l'assise

Une assise large et confortable (51 cm)

Détail des finitions

Dossier tapissé des 2 côtés. Accoudoirs 4D avec manchettes soft touch

Nuancier

Cuir

Assise et dossier



YB

Tissu

Assise et dossier



Cat. A
BONDAÏ



Cat. B
**STEP / STEP
MÉLANGE / CHILI**



Cat. C
SECRET

Nylon / Aluminium

Piètement



SV
Noir



SQ
Chromé

Mécanisme

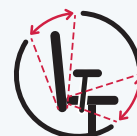

Synchrone ergonomique avec translation d'assise

Fabriqué en France



TARIF P. 98
Détails et disponibilités

TOUTES LES RESSOURCES EN LIGNE





Elton

+ Jeu de transparence !



Multi-espace

Il s'adapte aux espaces de travail ou de réunion



Confort souple

- Un siège tout en resille du dossier à l'assise
- Dossier souple, il suit les mouvements du dos

Confort de l'assise

Assise galbée et rembourrée à l'avant pour plus de confort

Nuancier

Résille

Assise et dossier



TI

Mécanismes



Basculant décentré (siège)



Oscillant (chaise)



TARIF P. 99

Détails et disponibilités

TOUTES LES RESSOURCES
EN LIGNE





Manhattan



Détails des finitions

Accoudoirs fixes chromés avec manchettes souples



Harly



Détail des finitions

Accoudoirs fixes chromés avec manchettes souples



Confort de la nuque

Tête fixe grande largeur pour un bon maintien des cervicales

Nuancier

Cuir

Vachette pleine fleur
Assise et dossier



YB
Noir



YC
Blanc

Mécanisme

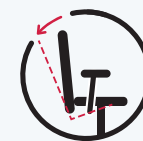

Basculant
décentré

TARIF P. 99

Détails et disponibilités

TOUTES LES RESSOURCES
EN LIGNE



Nuancier

Cuir

Croûte de cuir
Assise et dossier



YB
Noir

Mécanisme

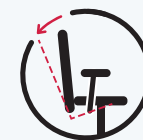

Basculant
décentré

TARIF P. 99

Détails et disponibilités

TOUTES LES RESSOURCES
EN LIGNE





Coach

+ L'élégance & le confort en plus



Confort de la nuque

Dossier résille : tête fixe
Dossier tissu : tête inclinable (30°) et ajustable (+ 6 cm)

Confort de l'assise

Assise au galbe accentué à l'avant pour favoriser la circulation sanguine

Confort du dos

- Dossier tissu réglable en hauteur (+ 6 cm)
- Dossier résille avec soutien lombaire (+ 6 cm)

Nuancier

Tissu

Assise et dossier



Cat. A
BONDÁI



Cat. B
STEP / STEP
MÉLANGE / CHILI



Cat. C
SECRET



Cat. E
CUIR

Résille

Dossier



IL

Nylon / Aluminium

Piètement



SV
Noir



SQ
Chromé

Mécanismes



- Synchrone
- Confort
 - Ergonomique avec translation d'assise

Fabriqué
en France



Hors accoudoirs



TARIF P. 100

Détails et disponibilités

TOUTES LES RESSOURCES
EN LIGNE





Opus

+ Un classique ultra personnalisable



Confort de la nuque

Tête RH inclinable (40°)
et ajustable (+6 cm)



Confort du dos

- Réglage en hauteur (dossier tissu et résille + 6 cm)
- Soutien lombaire optionnel pour (dossier résille uniquement +11cm)

Confort de l'assise

Une assise large et confortable (51 cm)

Version "Ergo +" pour plus de confort

- Assise négative
- Accoudoirs chromés pivotants à 360°
- Amplitudes de réglages de l'assise plus importantes

Nuancier

Tissu

Assise et dossier



Cat. A
BONDAÏ



Cat. B
**STEP / STEP
MÉLANGE / CHILI**



Cat. C
SECRET



Cat. E
CUIR

Résille

Dossier



IZ

Nylon / Aluminium

Piètement



SV
Noir



SQ
Chromé

Mécanismes



Synchrone

- Confort
- Ergonomique et Ergo + avec translation d'assise

Fabriqué
en France



Hors accoudoirs



TARIF P. 101

Détails et disponibilités

**TOUTES LES RESSOURCES
EN LIGNE**





Eliott

[] 3 types de dossiers



◀ **Dossier résille**



◀ **Dossier tissu**
(haut ou bas dossier)



◀ **Dossier matelassé**

Fabriqué
en France



Hors dossier matelassé et
piètement SQ



Le confort en un geste !

Posture haute
Version dessinateur



Population nomade ou sédentaire

Mécanisme autorégulé
ou personnalisable

Confort de l'assise

Un confort ferme
(assise moulée ép. 40 mm)
Avec translation
d'assise intégrée

Confort du dos

Dossiers tissu ou résille
fixes avec soutien lombaire
réglable intégré (+ 6 cm)

Zooms



Accoudoirs 3D
Manchette soft touch



Translation d'assise intégrée
Bouton de réglage sur l'assise

Nuancier

Tissu

Assise et dossier



Cat. A
BONDAÏ



Cat. B
**STEP
STEP MÉLANGÉ
CHILI**



Cat. C
SECRET



Cat. E
CUIR

Polypropylène

Dossier



Noir



Blanc

Résille

Dossier



IR
Blanc



IW
Noir

Nylon / Aluminium

Piètement



SV
Noir



SQ
Chromé

Mécanisme

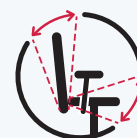

Synchrone

- Autorégulé
- Latéral
- Translation systématique intégrée à l'assise

TARIF P. 102

Détails et disponibilités

**TOUTES LES RESSOURCES
EN LIGNE**





Léon

[] 3 types de dossiers



◀ **Dossier tapissé**
avant / arrière



◀ **Dossier tissu**
Avant tapissé,
arrière polypropylène



◀ **Dossier résille**

Fabriqué
en France



◦ Bureaux ARIAL, p.100 - Écrans SOLANGE, p.116 - Tower
◦ GUSTAVE, p.128 - Rehausses, p.133



Personnalisable à l'envi !

Confort de la nuque

Tête à ajustable >



Confort de l'assise

- Un confort ferme (assise moulée, ép. 46,2 mm)
- Mécanisme ergonomique avec translation d'assise

Décoratif

La version tapissée au dos apporte une touche de couleur aux espaces

Confort du dos

Réglage en hauteur intuitif des dossiers (+6 cm)
Soutien lombaire intégré au dossier résille (+6 cm)

Nuancier

Tissu

Assise et dossier



Cat. A
BONDAÏ



Cat. B
**STEP
STEP MÉLANGE
CHILI**



Cat. C
SECRET

Polypropylène

Dossier



Noir



Blanc

Résille

Dossier



HB
Noir

Nylon / Aluminium

Piétement



SV
Noir



SQ
Chromé

Mécanismes



Synchrone

- Latéral
- Ergonomique avec translation d'assise

TARIF P. 103

Détails et disponibilités

**TOUTES LES RESSOURCES
EN LIGNE**



Zooms



Accoudoirs

1D ou 4D avec manchette soft touch



Poignées latérales

Pour réglage en hauteur du dossier



Oscar

[] 2 types de dossiers



◀
Dossier tissu



◀
Dossier résille

Fabriqué
en France



Pour dossier tapissé et
résille hors piètement SQ



Le design & le confort à prix accessible

Posture haute
Version dessinateur



Population nomade ou sédentaire

Mécanisme autorégulé
ou personnalisable

Confort ferme

Assise moulée
ép. 50 mm

Confort du dos

- Dossier tissu réglable en hauteur (+ 7 cm)
- Dossier résille avec soutien lombaire (+ 6 cm)

Zooms



Accoudoirs 1D ou 4D
Manchette soft touch



Soutien lombaire réglable
Intégré au dossier résille (+6 cm)

Nuancier

Tissu

Assise et dossier



Cat. A
BONDAÏ



Cat. B
**STEP
STEP MÉLANGE
CHILI**



Cat. C
SECRET

Polypropylène

Dossier



Noir



Blanc

Résille

Dossier



IW
Noir

Nylon / Aluminium

Piètement



SV
Noir



SQ
Chromé

Mécanismes

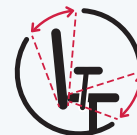

Synchrone

- Autorégulé
- Confort
- Ergonomique avec translation d'assise

TARIF P. 104

Détails et disponibilités

**TOUTES LES RESSOURCES
EN LIGNE**





Alter



Choix des options

- Dossier tissu ou résille
- Accoudoirs fixes ou 1D

Sol souple

Roulettes Ø50 mm

Pratique

Crochet portemanteau intégré au dossier

Nuancier

Tissu

Assise et dossier



KE



KC

Résille

Dossier



TI

Nylon

Piètement



SV

Noir

Mécanisme



Synchrone

TARIF P. 105

Détails et disponibilités

TOUTES LES RESSOURCES
EN LIGNE





Mia



.....
Dossier réglable en hauteur
Par volant (+ 7 cm)

.....
Accoudoirs fixes

Nuancier

Tissu

Assise et dossier



BI
Noir



BE
Bleu



SV
Noir

Nylon

Piètement

Mécanisme



Contact
permanent

TARIF P. 105

Détails et disponibilités

**TOUTES LES RESSOURCES
EN LIGNE**





Tom

VARIER LES POSTURES DE MANIÈRE LUDIQUE !

TOM est une assise ludique adaptée aux assises temporaires, par exemple pour attendre, téléphoner, prendre un café ou pour les réunions informelles courtes. Il est aussi idéal pour un moment de repos dans le cadre d'un travail debout.





Active & ludique

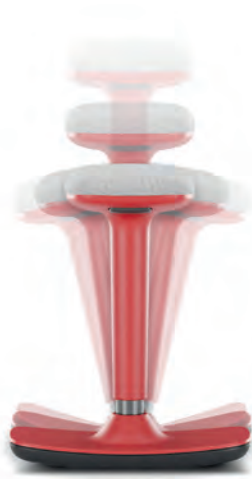

Assise active

Système de balancier pour éviter une posture statique et solliciter le bas du corps

Pratique

Il se déplace facilement de pièce en pièce

Debout ou semi-debout

Assise réglable en hauteur (de 53 à 76 cm)

Assise pivotante à 360°

Nuancier

Tissu

Assise



Cat. A
BONDAÏ



Cat. B
**STEP
STEP MÉLANGE
CHILI**



Cat. C
SECRET

Nylon

Piètement



SG



ZY

TARIF P. 106

Détails et disponibilités

TOUTES LES RESSOURCES EN LIGNE



⋮ Déconseillé pour les postes assis/debout qui nécessitent un siège de travail ergonomique en position assise



Nuancier

Tissu

Assise et dossier



Cat. A
BONDAÏ



Cat. B
**STEP
STEP MÉLANGE
CHILI**



Cat. C
SECRET

TARIF P. 106

Détails et disponibilités

TOUTES LES RESSOURCES EN LIGNE



Globe XXL



Fabriqué
en France



Hors accoudoirs



150 kilos supportés

(mécanisme avec ressort renforcé)

Mousse haute densité

non feu

Piètement métal

laqué noir

Mécanisme



Synchrone
Ergonomique avec
translation d'assise

Nuancier

Tissu

Assise et dossier



UD

24H Pro



Usage intensif

Siège 24 / 24H

Tissu haute résistance

et non feu EN1021-1,2

Supporte jusqu'à 150 kg

Mécanisme

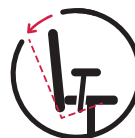

Basculant décentré

TARIF P. 106

Détails et disponibilités

TOUTES LES RESSOURCES EN LIGNE



Polyuréthane



Assises spécifiques en polyuréthane (forte résistance aux taches, agressions chimiques ou étincelles) pour laboratoires et ateliers.

.....
Assise réglable
en profondeur et en hauteur

.....
Repose-pied fixe
base chromée

.....
Patins antidérapants

Fabriqué
en France



Multiusage



.....
Revêtement
tissu noir Bali

.....
Assise réglable
en hauteur (10 cm)

.....
Roulettes
sol souple



Nuancier

Polyuréthane
Assise et dossier



PA

TARIF P. 107

Détails et disponibilités

**TOUTES LES RESSOURCES
EN LIGNE**



Nuancier

Tissu
Assise



FA

TARIF P. 107

Détails et disponibilités

**TOUTES LES RESSOURCES
EN LIGNE**





Chaises & tabourets



Isabel

RÉUNION

DIRECTION

Page 230 ›

.....



Inventiv

RÉUNION

Page 232 ›

.....



Elton

RÉUNION

DIRECTION

Page 234 ›

.....



Romy

RÉUNION

FORMATION

RESTAURATION

Page 236 ›

.....



Emi

RÉUNION

FORMATION

Page 240 ›

.....



Scott

RÉUNION

RESTAURATION

Page 244 ›

.....



Rosalie

RÉUNION

FORMATION

RESTAURATION

Page 246 ›

.....



Meeting+

RÉUNION

FORMATION

RESTAURATION

Page 248 ›

.....



Anthra+

RÉUNION

FORMATION

Page 249 ›

.....



Geo

RÉUNION
FORMATION

Page 249 ›

.....



Evasion

ESPACE INFORMEL
RESTAURATION

Page 250 ›

.....



Sofia

ESPACE INFORMEL
RESTAURATION

Page 252 ›

.....



Tara

ESPACE INFORMEL
RESTAURATION

Page 254 ›

.....



Line

OUTDOOR
RESTAURATION

Page 256 ›

.....



Gelati

OUTDOOR
RESTAURATION

Page 258 ›

.....



Spoon

RESTAURATION

Page 260 ›

.....



Tic

RESTAURATION

Page 261 ›

.....



Isabel

L'INDISPENSABLE CHAISE VISITEUR

Conçue pour les espaces de réunion et de direction, ISABEL est une chaise qui se caractérise par son design intemporel et son confort. Disponible en version bas ou haut dossier, avec piétement luge ou conférence, elle s'adapte à tous les usages et habille avec élégance les espaces.

Fabriqué
en France



Luge



Elégante & confortable

Dossier tissu ou résille

Un choix esthétique et de confort (dossier résille plus respirant)



Détails des finitions

Dossier tapissé des 2 côtés



Multi-espace

Espace de travail ou réunion

Confort ferme et durable

(mousse moulée ép. 50 mm)

Choix des piétements

- Piétement luge : il offre un léger amorti à l'assise
- Piétement conférence avec mécanisme basculant (croix ou 5 branches roulettes)

Nuancier

Tissu

Assise et dossier



Cat. A
BONDAÏ



Cat. B
STEP
STEP MÉLANGE
CHILI



Cat. C
SECRET

Cuir

Assise et dossier



YB
noir

Résille

Dossier



IN
noir

Métal

Piétement



SB
Gris



SG
Noir



SQ
Chromé

TARIF P. 110

Détails et disponibilités

TOUTES LES RESSOURCES
EN LIGNE





Classique ou colorée



Inventiv'

Multi-espace

Espace de travail, réunion ou formation

Douceur des lignes

Pieds légèrement galbés

Dossier tissu ou résille

Un choix esthétique et de confort
(dossier résille plus respirant)

Finitions variées

Résille blanche ou noir
3 couleurs de piétement

Fabriqué
en France



4 pieds fixe



Avec tablette
écrivain



Luge





Nuancier

Tissu

Assise et dossier



Cat. A
BONDAÏ



Cat. B
STEP
STEP MÉLANGE
CHILI



Cat. C
SECRET

Résille

Dossier



UH
Noir



UM
Blanc

Métal

Piètement



SP
Blanc



SB
Gris



SG
Noir



Zooms



Accoudoirs avec tablette écriteire
À droite



Chariot de transport
Il permet d'empiler jusqu'à
6 chaises 4 pieds

TARIF P. 111

Détails et disponibilités

**TOUTES LES RESSOURCES
EN LIGNE**





Elton

UN CONCENTRÉ D'ERGONOMIE, DE TECHNOLOGIE ET DE DESIGN

ELTON est issu d'une technologie qui permet d'obtenir une assise entièrement en résille. La souplesse de la maille associée au mécanisme des sièges offrent un confort optimal pour des assises prolongées. Une technologie haute résistance qui apporte confort et style épuré aux espaces de réunion ou direction.





Jeu de transparence !

Accoudoirs fixes



Tous types de sol

Roulettes sol souple
sol dur 65 mm

Confort souple

Un siège tout en resille
du dossier à l'assise

Confort de l'assise

Assise galbée et rembourrée
à l'avant pour plus de confort

Confort du dos

Dossier souple, il suit
les mouvements du dos

Nuancier

Résille

Assise et dossier



TI
Noir

Nylon

Piètement



SV
Noir

Mécanisme

Dossier



Oscillant

TARIF P. 99

Détails et disponibilités

TOUTES LES RESSOURCES
EN LIGNE





Romy

LA CHAISE RESPONSABLE ET MODERNE

A l'origine de ROMY, une conception innovante qui permet un assemblage sans vis et sans outils de la chaise par un système de verrouillage modulaire. Une solution intelligente qui facilite son recyclage tout en lui apportant une versatilité d'usages et de couleurs.

Fabriqué
en France





Mobile ou fixe, avec ou sans accoudoirs, avec ou sans tablette, ROMY se personnalise à l'envi. Enfin, la forme de l'assise et du dossier a été dessinée spécifiquement pour apporter un confort immédiat à son utilisateur.



Responsable & moderne



Multi-espace

Espace de travail, réunion, formation ou restauration

Multiusage

- Mobile ou fixe,
- Avec ou sans tablette
- Placet d'assise en option

Multicolore

Assise color block ou bicolore : couleurs à mixer entre les assises et les pieds



En version polypropylène, ROMY est fabriquée avec des matériaux 100% recyclables (assises et pieds)

- L'assise, le dossier et les accoudoirs en polypropylène contiennent 63% de matières recyclées
- Son assemblage sans vis garantit un démontage simple.



Nuancier

Tissu

Placet d'assise

Cat. A
BONDAÏCat. B
STEP
STEP MÉLANGE
CHILICat. C
SECRET

Polypropylène

Dossier, assise,
accoudoirs**PX Gris****PT Blanc****PU Noir****PW Jaune****PZ Rouge**

Métal

Piétement

**SB Gris****SP Blanc****SG Noir****SX Jaune****ZY Rouge**

* Couleur des assises,
des dossiers et des
accoudoirs, toujours
identiques - Possibilité
de varier la couleur du
piétement.

TARIF P. 112

Détails et disponibilités

**TOUTES LES RESSOURCES
EN LIGNE**

Confort immédiat

Une assise large avec
un dossier enveloppant

Pratique

- Chaise résistante, lavable
- Empilable (jusqu'à 15 chaises sur chariot)

Tablette amovible

Sans outils

Options



Pièces d'accroche

Pour chaise sans accoudoirs



Pour chaise avec accoudoirs



Emi

ELLE SE PLIE À VOS ENVIES !

EMI a été spécialement conçue pour créer des espaces flexibles et polyvalents. Sa conception ingénieuse lui permet de reconfigurer les espaces avec une étonnante facilité.

Fabriqué
en France



Assises en poly-
propylène pieds
fixes ou roulettes



Assise
tapisée
pieds fixes



Assise
tapisée
pieds roulettes



GARANTIE
5
ANS



12
%



Ses assises fixes ou mobiles se déplacent avec légèreté. Il suffit d'un geste pour basculer les tables, plier les chaises afin de les ranger. Empilable horizontalement et verticalement jusqu'à 20 pièces, EMI optimise les espaces de stockage.



Empilable à la verticale & à l'horizontale





Mobile & flexible



Multi-espace

Espace de travail,
réunion ou formation



Options multiples

- Assises fixes ou rabattables
- Avec ou sans accoudoirs
- Avec ou sans roulettes



Stockage optimisé

Empilement vertical ou horizontal
(jusqu'à 20 chaises)



Confort immédiat

Mousse moulée ép. 20 mm

Nuancier

Tissu

Assise



Cat. A
BONDAÏ



Cat. B
**STEP
STEP MÉLANGE
CHILI**



Cat. C
SECRET

* Tissu sur base
polypropylène noir PU

Polypropylène

Assise et dossier



PU
Noir

Résille

Dossier



UH
Noir

Métal

Piètement



SQ
Chromé

TARIF P. 113

Détails et disponibilités

**TOUTES LES RESSOURCES
EN LIGNE**





Scott

NOUVEAU

UNE ASSISE COSY ET MULTIUSAGE

Grâce à son dossier enveloppant, SCOTT apporte un grand confort d'assise et habille avec élégance les espaces. Disponible en version 4 pieds en polypropylène, en bois, en fibre de bois ou pieds conférence, avec 7 couleurs au choix dont 3 issus de matériaux 100% recyclés, SCOTT permet de répondre à tous les espaces et styles. SCOTT est également proposé en version entièrement tapissée, disponible dans 47 tissus.

Fabriqué
en France





Enveloppante & multiusage



Piètement fibre de bois

Assise enveloppante et confortable

Version entièrement tapissée

Multi-espace
Espace de travail, restauration, réunion ou informel



Personnalisable

- 47 tissus disponibles
- 7 couleurs de coque avec placet d'assise en options
- 4 types de pieds :
 - 4 pieds bois
 - 4 pieds fibre de bois
 - 4 pieds polypropylène
 - Piètement conférence

Durable

- 1 catégorie de tissu Chili
- 100% polyester recyclé
- 3 nuances issues de matériaux 100% recyclés

Lavable

(coque polypropylène)

Nuancier

Tissu

Assise*, dossier* et placet d'assise



Cat. A
BONDAÏ



Cat. B
STEP STEP MÉLANGE CHILI



Cat. C
SECRET



Cat. D
FENICE

* Sauf CAT D Secret

Polypropylène Assise



PB
Neige



QW
Taupe



PM
Rose poudré



PN
Turquoise

Polypropylène recyclé Assise



OQ
Noir



OZ
Gris clair



O9
Brique

TARIF P. 115

Détails et disponibilités

TOUTES LES RESSOURCES EN LIGNE





Rosalie

Zooms



Manette de réglage de la hauteur d'assise

Piètement conférence : + 13 cm
Piètement roulettes : + 12,5 cm



Tablette écrivain

Fabriqué en France





Ludique & polyvalente



Nuancier

Tissu

Placet d'assise



Cat. A
BONDAÏ



Cat. B
**STEP
MÉLANGE
CHILI**



Cat. C
SECRET



Cat. D
**FENICE
VOGUE**

Polypropylène

Assise



PS
Blanc crème



PQ
Gris



PJ
Jaune



PR
Noir

Métal

Piétement



SQ
Chromé



SG
Noir

Facile à déplacer

Prise de main
intégrée à
la coque

Version campus

Une version tout
en un avec tablette
écrivain pivotante à
360° et dépose sac
intégré

Multi-espace

Espace de
travail, réunion ou
formation

Assise enveloppante et confortable

Placet d'assise en option

TARIF P. 116

Détails et disponibilités

TOUTES LES RESSOURCES EN LIGNE





Nuancier

Polypropylène

Assise



PT
Blanc



PY
Anthracite



PU
Noir



PZ
Rouge



PC
Vert sapin

Métal

4 pieds



SQ
Chromé



SO
Blanc



X1
Anthracite



SG
Noir



ZY
Rouge



SW
Vert sapin

Meeting+

Légères

Elles se transportent et s'empilent facilement (jusqu'à 15 pièces)

.....

Non feu

Coque M2 (option)

.....



.....

Colorées

5 couleurs d'assises au choix sur piétement chromé ou de couleur assortie à la coque



.....

Tablette écrioire
(option)

TARIF P. 117

Détails et disponibilités

**TOUTES LES RESSOURCES
EN LIGNE**



Surface
antibact rienne



Sans
accoudoirs



Avec tablette
 crioire



GARANTIE
2
ANS



Anthra+



Multifonction

Elle s'accessorise facilement



Dossier au choix

Tissu ou résille



Empilable

Jusqu'à 12 pièces



sans
accoudoir
sans tablette
écritoire



avec
accoudoir
sans tablette
écritoire



Géo



Piante



Maniable

Polyvalente

Nuancier

Tissu

Assise et dossier



Cat. A
BONDAl



Cat. B
STEP

Résille Dossier



TI Noir

Métal Piétement



SB Gris



SG Noir

TARIF P. 118

Détails et disponibilités

TOUTES LES RESSOURCES EN LIGNE



Nuancier

Tissu

Assise et dossier/
Piétement



FA/SG
Noir céleste / Noir



FG/SG
Gris orage / Noir

Simili cuir

Assise et dossier/
Piétement



YA/SQ
Noir / Chromé

TARIF P. 118

Détails et disponibilités

TOUTES LES RESSOURCES EN LIGNE





Évasion

POUR UN ESPACE NATUREL

Alliance subtile du métal et du hêtre naturel, la gamme EVASION séduit grâce à ses lignes graphiques et élancées. Complète, elle propose autant des tables que des assises coordonnées. Disponible en plusieurs formes et dimensions, EVASION s'adapte aussi bien aux espaces de restauration qu'aux espaces de réunion.

Fabriqué
en France





Moderne & chaleureux



Faciles à déplacer

Prise de main intégrée au dossier

Lavable et résistante

(assise en hêtre multipli stratifié, chant huilé)



Confortable

Repose-pieds zingué anti-traces



Détails des finitions

Décor métallique du pied bois coordonné aux assises (blanc ou noir)

Nuancier

Hêtre

Assise et décor



VKZOMS

Blanc
hêtre massif



VMZPMS

Noir
hêtre massif

Possibilité de sélectionner d'autres finitions métal, cf. nuancier général

TARIF P. 119

Détails et disponibilités

**TOUTES LES RESSOURCES
EN LIGNE**





Sofia

LA CHAISE À L'ESPRIT 50'S

SOFIA allie subtilement le charme rétro des années cinquante et la rigueur du style nordique. Cette double alliance lui donne une grande polyvalence de style, tantôt ludique dans ses couleurs les plus chaudes, tantôt sobre et élégante dans ses tonalités les plus froides.





Esprit 50's

Multi-espace

Le tabouret est idéal pour les tables hautes dans les espaces projets ou restauration



Généreuses et confortables

Largeur d'assise L. 44 cm

Facilement lavable

(coque polypropylène)

Nuancier

Polypropylène Assise



Métal 4 pieds



TARIF P. 119

Détails et disponibilités

TOUTES LES RESSOURCES EN LIGNE





Tara

UNE ASSISE AU CONFORT SOUPLE

En y prenant place, TARA surprend par la souplesse et le confort de son dossier qui assure à son utilisateur une sensation de confort immédiat. Les matériaux employés sont réduits au minimum, rendant la chaise optiquement et physiquement légère.



Fabriqué
en Europe



Chaises



Tabourets



GARANTIE
2 ans



53
%



Originale & colorée



Légères

Elles se transportent
et s'empilent facilement
(jusqu'à 6 pièces)

Dossier flexible

pour un confort souple



Facilement lavable

(coque polypropylène)



Color block

Couleur des pieds assortie à la couleur de la coque

Nuances

Polypropylène/ Métal

Assise et piétement



PTSO
Blanc



POZ5
Rouge grenat



PPZ6
Vert foncé



PUSG
Noir



XKZY
Rouge



PIZ7
Gris chaud

TARIF P. 120

Détails et disponibilités

**TOUTES LES RESSOURCES
EN LIGNE**





Line

LA CHAISE BISTROT REVISITÉE

Inspirée des chaises de café des années 20, LINE surpasse ses ancêtres en bois par sa technicité. Fabriquée en une pièce de polypropylène, LINE résiste aux vents et aux intempéries. Indoor ou outdoor, pratique et confortable, elle signe les espaces restauration d'un style vintage revisité.





Rétro & outdoor



Légères

Elles se transportent et s'empilent facilement (jusqu'à 6 pièces)

Color block

Couleur des pieds assortie à la couleur de la coque



Lavable et pratique

La version avec accoudoirs permet un appui sur table pour faciliter le nettoyage des sols



Indoor et outdoor

Traitement anti-UV

Nuancier

Polypropylène

Assise, dossier et piétement



PT
Blanc



PO
Rouge grenat



PP
Vert foncé



PU
Noir



QF
Sable



QG
Marron



PI
Gris chaud

TARIF P. 120

Détails et disponibilités

**TOUTES LES RESSOURCES
EN LIGNE**





Gelati

LA CHAISE CONTEMPORAINE

GELATI est une chaise au style contemporain qui s'intègre facilement dans tous les espaces.

Son assise légère, traitée anti-UV, permet un usage en intérieur comme en extérieur. Disponible en version chaise ou tabouret, elle complète autant les tables restauration que les tables projets des espaces de travail.





Indoor & outdoor



Multi-espace

Le tabouret est idéal pour les tables hautes dans les espaces projets ou restauration

Indoor et outdoor

Traitement anti-UV et anti-corrosion (piètement blanc et noir uniquement)



Personnalisable

3 couleurs de pieds au choix : chromé, noir ou blanc



Lavable

(coque polypropylène)

Nuancier

Polypropylène Assise



PT
Blanc



QA
Gris



PU
Noir



PV
Bleu ciel



QH
Vert forêt



XK
Rouge

Métal Piètement



SQ
Chromé



SO
Blanc



SG
Noir

TARIF P. 120

Détails et disponibilités

**TOUTES LES RESSOURCES
EN LIGNE**





Spoon

+ L'alliance du bois et de la couleur



Lavable et résistante

Revêtement stratifié

Monocouleur ou bicouleur

Blanc/rouge ou blanc/bleu

Confortable

Repose-pieds zingué anti-traces

Tabouret avec lift réglable

en hauteur (+ 26 cm)

Nuancier

Méla mine

Assise



VK
Blanc



RN
Blanc/Rouge



RI
Chêne clair

Métal

Piètement



SQ
Chromé

TARIF P. 121

Détails et disponibilités

TOUTES LES RESSOURCES
EN LIGNE





Tic

+ Idéale pour les espaces de restauration



.....

Lavable et résistante

Hêtre verni

.....

Facile à déplacer

Prise de main intégrée
au dossier

Nuancier

Hêtre

Assise



WP

Métal

Piètement



Gris
aluminium

TARIF P. 121

Détails et disponibilités

**TOUTES LES RESSOURCES
EN LIGNE**



Chaises



Appui sur
table



Garantie
2 ans





Accessoires





Accessoires



Luminaires

Page 266 ›

.....



Végétaux décoratifs

Page 268 ›

.....



Tri sélectif

Page 270 ›

.....



Porte-manteaux & Vestiaire

Page 272 ›

.....



Tableaux écritoire & affichage

Page 273 ›

.....



Bras support écrans

Page 274 ›

.....



Supports Multimédia

Page 277 ›

.....



Accessoires de bureau

Page 277 ›

.....



Connectique

Page 278 ›

.....



Lampes



OL05 - 810 lumen
3 articulations



DL05 - 806 lumen
Abat jour façon bois ou lin
Pied bois teinté



OL08 - 810 lumen
2 articulations avec rotules



OL02 - 650 lumen
5 intensités d'éclairage
3 températures de couleur
Port USB + chargeur induction



DL08 - 2 x 806 lumen
Look rétro
Métal laqué



OL07 - 510 lumen
3 intensités d'éclairage
3 températures de couleur
Bras flexible



Lampadaires



FL09 – 9059 lumen

- Eclairage direct / indirect
- Avec ou sans détecteur de présence



CL05 – 1100 lumen

- Abat jour façon bois ou lin
- Pied bois teinté



FL02 - 2100 lumen

- Variateur d'intensité
- Métal peint



CL09 – 1100 lumen

- Abat jour en chinz
- Pied avec tablette intégrée en métal peint



Autres coloris disponibles cf. tarif

TARIF P. 124

Détails et disponibilités

TOUTES LES RESSOURCES
EN LIGNE



Végétaux décoratifs en pot



Graminée
H. 90 à 180 cm



Ficus bonzaï
H. 149 à 180 cm



Bambou
H. 160 à 200 cm



Herbes des champs
H. 125 cm

Des ensembles complets
Pot, plante et gravier inclus

Bois naturel
Feuillage artificiel

Finition laquée brillante
Pour les pots ronds

Finition mate
Pour les pots carrés

Nuancier

Laqué
Pots ronds



07
Blanc



05
Taupe



08
Noir

Mat
Pots carrés



0G
Blanc



06
Taupe



0K
Anthracite

Fabriqué
en France





Végétaux décoratifs en bac



Papyrus
H. 127 cm



Bambou
H. 197 cm



Graminée folle
H. 70 à 200 cm



Sépare les espaces
Différentes hauteurs au choix

3 types de plantes
Papyrus, graminée folle ou bambou

Habillage de finition
Gravillons décoratifs en quartz ou calcaire

Léger & qualitatif
Bac en fiberstone matériau léger

Nuancier

Fiberstone



OG
Blanc



OF
Noir



Ensemble éco-responsable :
pour chaque bac acheté, des
arbres sont plantés

Fabriqué
en France



TARIF P. 126
Détails et disponibilités
TOUTES LES RESSOURCES
EN LIGNE





Tri sélectif

Poubelle individuelle



Corbeille principale 26 L.

Adaptée pour le format A4
Fabrication 100% recyclée
(coloris noir uniquement)

[o] Options



◀
Bac 5 L.
pour déchets
organiques



◀
Bac 9 L.
pour déchets
plastiques



◀
Couvercles
pour les bacs 5 et 9 L.

Fabriqué
en France





Poubelles collectives

+ Responsables & modulaires



Capacité 60 L.

Avec bac plastique extractible (inclus)

Pictogrammes colorés

Pour identifier la destination des déchets

Mobile

Elle se déplace facilement

Robuste

Tôle d'acier ép. 10/10

Options



Pièces de liaison



Couvercle
(recommandé pour la poubelle organique)



Porte arrière

Fabriqué en France



TARIF P. 127
Détails et disponibilités

TOUTES LES RESSOURCES EN LIGNE





Porte-manteaux

30%
%

Wotan

- 8 patères
- 4 accroches pour sac
- 4 anneaux porte-parapluies



Basty

- 8 patères
- 4 accroches pour sac
- 4 anneaux porte-parapluies



Flora

- 7 patères
- 4 emplacements parapluies



Aloès

- 6 patères oblongues
- 2 emplacements parapluies

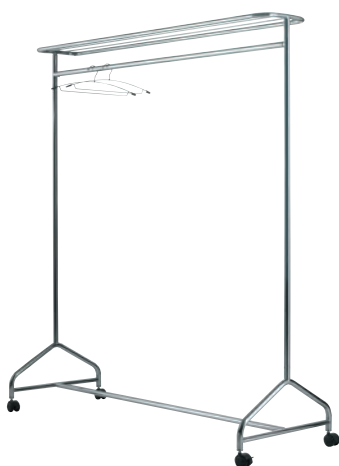

Vestiaire mobile



Avec porte chapeaux,
Capacité : 40 manteaux



Patères magnétiques

29%
%

Fixation sur tout support métallique
Résistance 9 à 11 kg



Nuancier

Wotan



Noir

Basty



Chromé

Flora



Blanc



Noir

Aloès



Aluminium

TARIF P. 128

Détails et disponibilités

TOUTES LES RESSOURCES
EN LIGNE

Tableaux écritoire

09 %

Fixation verticale ou horizontale (visserie fournie)



- Cadre aluminium**
- Laqué - 90 x 120 cm
 - Émaillée 60 x 90 cm, 90 x 120 cm, 120 x 180 cm
 - Surface magnétique et effaçable à sec



- Sans Cadre**
- Laqué : 75 x 115 cm
 - Surface magnétique et effaçable à sec



- Chevalet mobile**
- H. 186 cm
 - Fond magnétique en tôle laquée



- Kit accessoires**
- Marqueurs + aimants + brosse magnétique + produit nettoyant

14 %

Tableau affichage

14 %

Fixation verticale ou horizontale (visserie fournie)



- Tableau affichage**
- Liège naturel ép. 12 mm
 - 60 x 90 cm – 90 x 120 cm

TARIF P. 129
Détails et disponibilités

TOUTES LES RESSOURCES EN LIGNE



Accessoires de bureau

56 %



- Tiroir vide poches**
- En métal
Fixation sous plateau



- Repose pieds**
- Selon modèle, hauteur réglable sur :
- 2 positions et 6 angulations
 - 4 positions et 4 angulations



- Corbeille métallique**
- Capacité 20L

TARIF P. 130
Détails et disponibilités

TOUTES LES RESSOURCES EN LIGNE





Bras supports écrans

Leurs systèmes de réglages permettent d'adapter la hauteur de l'écran et ainsi éviter les problèmes de dos et de cervicales

Sur plateau ?

Leurs avantages : ils se fixent facilement peu importe le plateau. Ils se glissent à travers une échancrure, un obturateur ou ils viennent simplement se pincer sur le plateau

Sur rail ?

Une solution gain de place qui optimise encore plus la surface de votre espace de travail ! A fixer sur un panneau écran LUCIEN (cf. p. 123)



Tous nos bras supports écrans sont compatibles avec la norme VESA 75 ou 100 mm



À fixer sur plateau

Un système évolutif, pour 1 ou 2 écrans !

1. Choisir sa longueur de bras



Portée 28 cm - Simple extension
Bras simple ou double



Portée 43 cm - Double extension
Bras simple ou double

2. Choisir sa fixation



Fixation 3 en 1

- Pour plateaux ép. 10 à 50 mm
- Sur pince P. 25 mm
- Sur tige via l'obturateur ou par percement du plateau



Sur pince P. 65 mm

- Pour plateaux ép. 13 à 25 mm
- Compatibles avec panneaux écrans SOLANGE (cf. p. 116)



Pinces disponibles pour 1 ou 2 écrans

Besoin de passer de 1 à 2 écrans ?

Il suffit de commander une nouvelle pince 2 écrans et 1 bras supplémentaire !

Caractéristiques techniques

- Bras articulé en aluminium à vérin pneumatique simple ou double extension (portée 28,3 cm ou 43,3 cm).
- Guide câbles intégré
- Pivote à 360°
- Taille d'écran : jusqu'à 27 pouces. Charge maxi : 7 kg



Bras support écran

À fixer sur plateau

Economique

- 4 articulations sur mat
- Pour 1 ou 2 écrans
- Taille d'écran : de 10 à 32 pouces
- Charge maxi : 8 kg
- Fixation au plateau : sur pince ou tige (par percement plateau)



1 écran



2 écrans

Standard

- 4 articulations avec ressort à gaz
- Pour 1 ou 2 écrans
- Taille d'écran : de 17 à 32 pouces.
- Charge maxi : 9 kg
- Fixation au plateau : sur pince ou tige (par percement plateau)



A fixer sur rail

Economique



1 écran

- Charge maxi : 8 kg, L.13 cm
- 2 articulations.



1 écran

- Charge maxi : 6 kg, L. 24,5 cm
- 3 articulations.

TARIF P. 131

↓ Détails et disponibilités

TOUTES LES RESSOURCES
EN LIGNE



Compatible avec les panneaux écrans LUCIEN



Support clavier



Finition ABS

Fixation sous plateau
Porte crayons intégré
Réglage en hauteur de 2 à 5 cm

Supports UC



Support par bras métal

- Finition gris aluminium, blanc ou noir
- Conseillé pour bureaux AXEL & LUTZ 2



Support par bras métal

Finition gris aluminium



Support par sangles réglables

Finition gris aluminium

Tables informatiques



Table multiusage mobile

- Plateau mélamine blanc ép. 25 mm
- Structure métallique gris aluminium



Poste informatique

- Plateau mélamine hêtre ép. 19 mm
- Structure métallique gris clair
- Équipée de 4 roulettes dont 2 avec freins



TARIF P. 132

Détails et disponibilités

TOUTES LES RESSOURCES
ON LINE



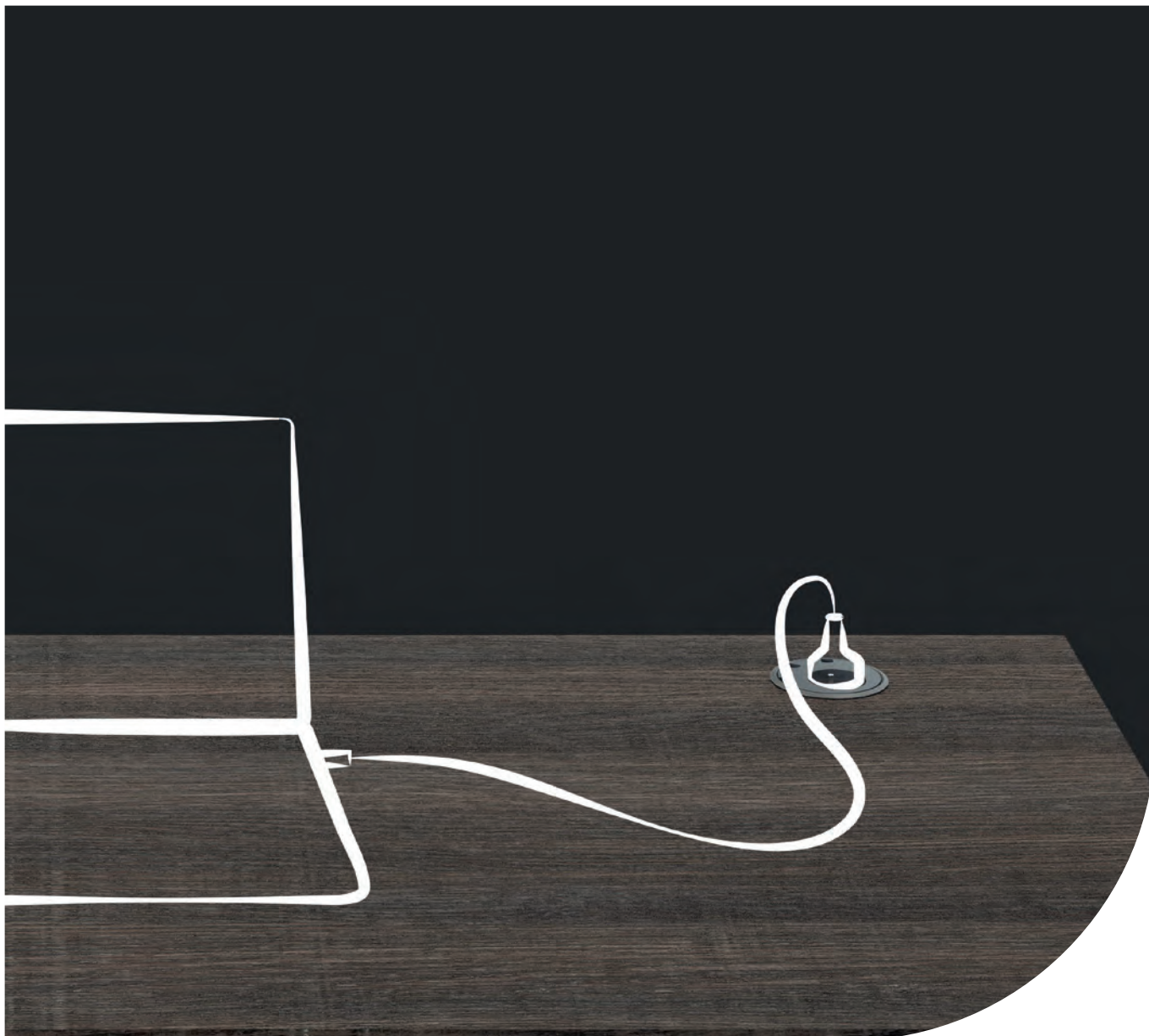

Connectique

Quelle connectique pour mon bureau ?

La connectique est un élément important du bien-être des collaborateurs ! Elle doit être facilement accessible et discrète pour ne pas prendre trop de surface de travail. Pour connecter son smartphone, sa tablette, son PC, les solutions sont nombreuses et s'adaptent à votre usage.



TARIF P. 133
Détails et disponibilités
**TOUTES NOS SOLUTIONS
D'ELECTRIFICATION**





Pour les populations nomades ou les espaces flexibles

Le choix d'une connexion directe : un mode de connexion rapide et pratique



Obturbateurs électrifiés

- Avec ou sans capot coulissant
- Selon modèle avec courant fort, port USBA ou C, RJ45 ou HDMI



Boîtiers nomades

- Cube multiprises à poser
- Boîtier design à poser ou à fixer
- Bloc prises à fixer

Pour les populations sédentaires ou les espaces premium

Le choix du confort et de l'esthétique avec une trappe d'accès : elle masque le bloc prises, tout en permettant un accès direct à la connectique

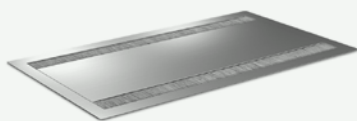

Trappes soft-closing

Trappe simple accès
ou double accès



Avec ou sans bloc prises

Connectique au choix :
Avec ports USBA ou C,
RJ45 ou HDMI

Pour une solution économique

Optez pour un obturbateur simple pour le passage des câbles, ou un bloc prise posé directement dans la goulotte. Il sera accessible à travers un plateau coulissant, avec échancrure ou via une trappe sans nourrice

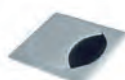

Obturbateurs simples



Bloc prises avec courant fort

Connectique au choix avec
port USBA ou C, RJ45 ou HDMI



Câbles d'alimentation

2 ou 3 mètres



Gestion des fluides

Comment bien organiser les câbles ?

Pour un espace ordonné propice à la concentration et au bien-être des collaborateurs, mieux vaut organiser la gestion des câbles. Goulotte simple ou double, carter ou vertèbre, nous avons la solution à votre usage !

TARIF P. 135

Détails et disponibilités

TOUTES NOS SOLUTIONS
D'ELECTRIFICATION





Organisez les câbles sous le plateau

Grâce à une goulotte ou un organisateur de câbles
Pour poste solo ou partagé

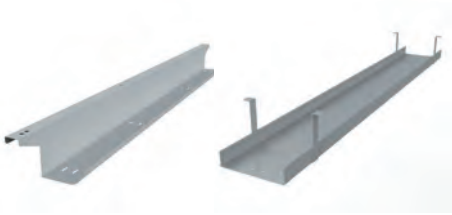

^
Goulottes métalliques
Simple ou double



^
Goulotte filaire



^
Organisateur de câbles
(lot de 2)

Masquez les câbles qui descendent vers le sol

Au choix : un carter aimanté ou à clipser sur le pied ou des solutions plus souples
comme la vertèbre extensible ou la gaine zippée



^
Carters métalliques
Clipsé ou aimanté



^
Vertèbres extensibles
Pour bureaux fixes ou
réglables en hauteur



^
Gaine zippée
3 longueurs au choix

Choisissez un voile de fond

Spécifique au bureau individuel, appelé aussi voile de courtoisie, il complète l'aspect
d'un bureau ordonné



^
Voiles de fond métalliques



^
Voiles de fond tissu

- Rabattable
- Plaque métallique de rigidification



^
**Voiles de fond
méla mine ép. 19 mm**

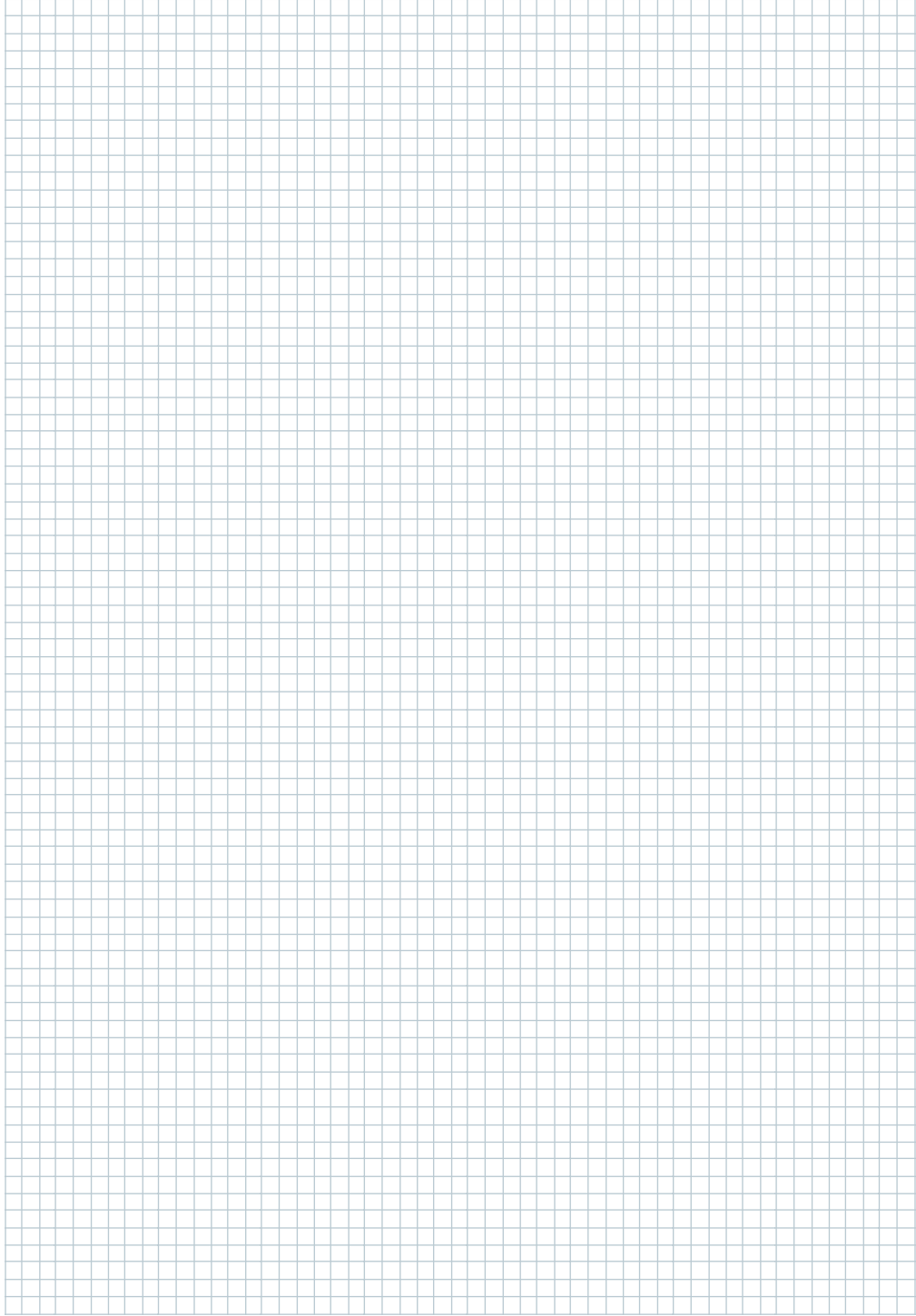



Nuancier

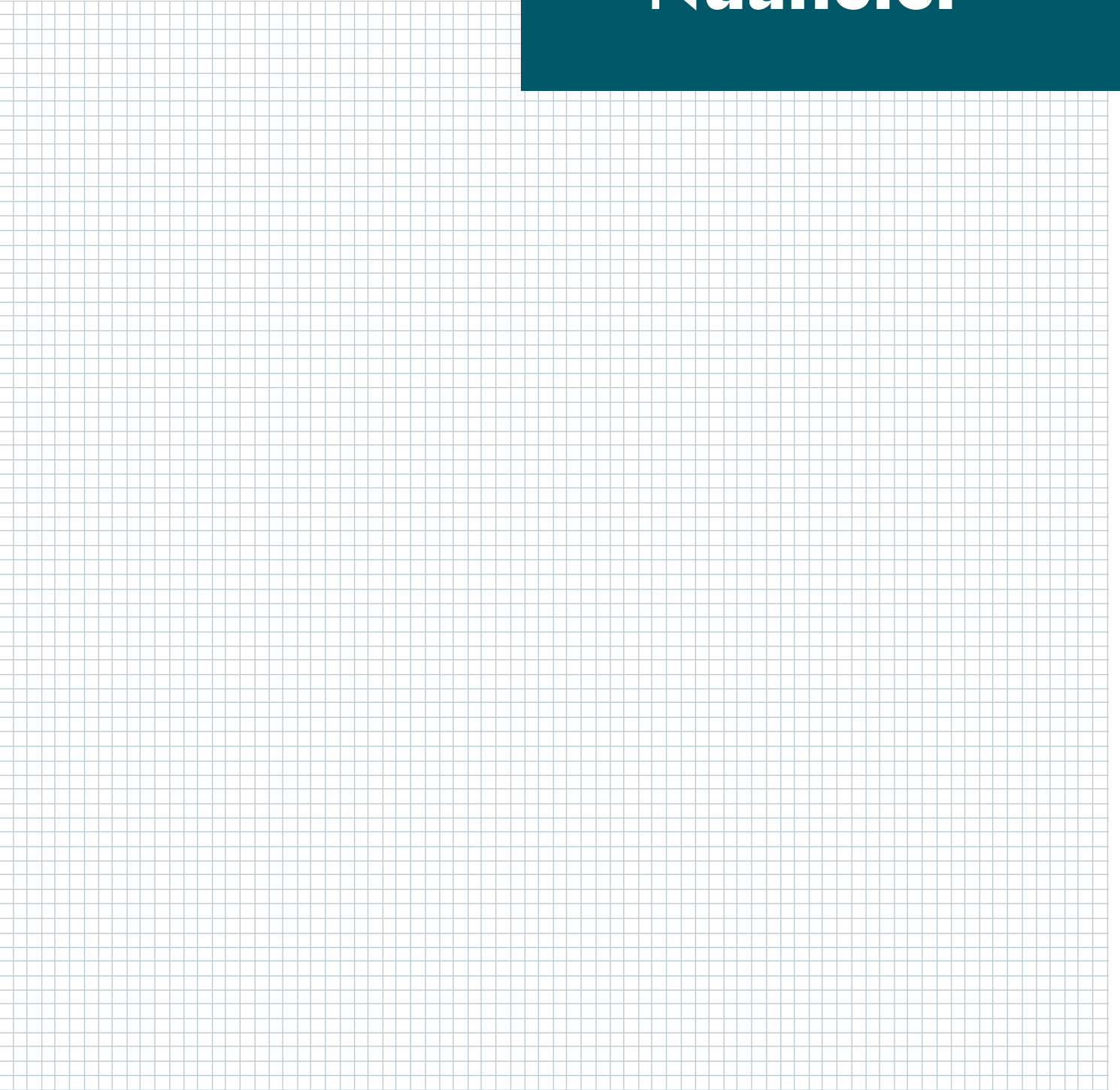



Mélangine bois



MA
Érable blanc



R2
Hêtre de Honfleur



RI
Chêne clair



RZ
Acacia de Lakeland

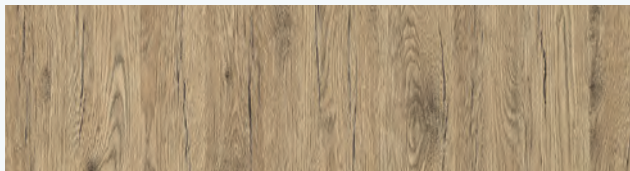

R3
Chêne Brunswick



N8*
Pin maritime

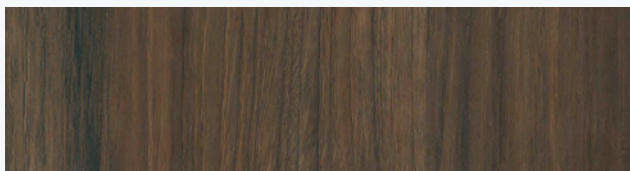

N6
Noyer brun

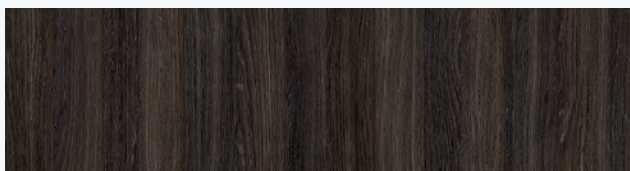

M9
Chêne café

Mélangine unis



MG
Blanc neige



M5
Gris brume



N7
Gris perle

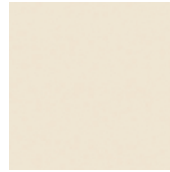

N5
Lin



M7
Vert Fjord



N9
Noir

Mélangine soft touch



MK
Noir velours



Toucher
velours



Effet
mat

Stratifié

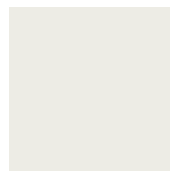

HZ
Blanc



VW
Noir

*N8 Pin maritime : chants spécifiques multiplis

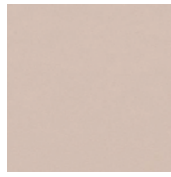
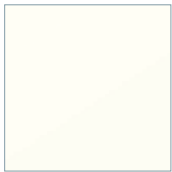
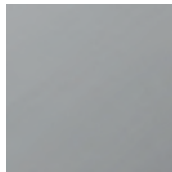
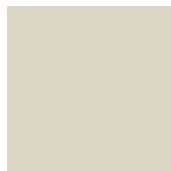
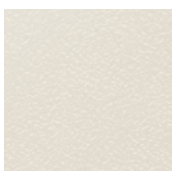
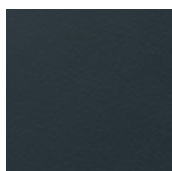
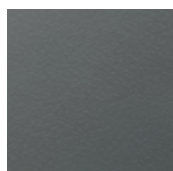
**Linoléum****LU**
Gris ardoise**L4**
Gris taupe**L2**
Vert pistache**L1**
Rose poudré**Altuglas®****OA**
Blanc satin**Verre****GS**
Blanc**Métal lisse****SO**
Blanc**SA/SB*/Z4****
Gris aluminium**SD**
Gris clair**SG**
Noir**X1**
Anthracite**X2**
Gris platine**X4**
Bleu cobalt**X8**
Vert pâle**SH**
Tomette**ST**
Vert anglais**ZC**
Blanc nacré**Z3**
Laiton**Métal structuré****ZO**
Blanc**SC**
Anthracite**SU**
Gris souris**ZP**
Noir

*SB : spécifique Rangements

**Z4 : spécifique Bureaux AXEL et LUTZ 2



Bondaï (Cat. A)

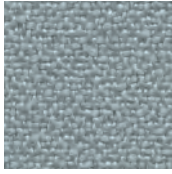

KD
Gris nuage

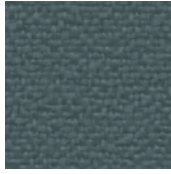

KA
Gris orange



KE
Noir

Chili (Cat. B)

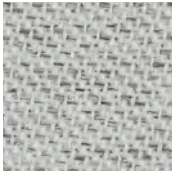

BC
Gris clair chiné



BD
Gris Noir

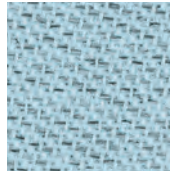

BF
Bleu givré chiné

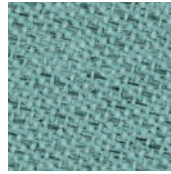

BG
Céladon chiné

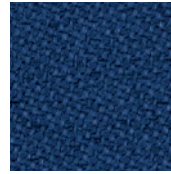

BH
Bleu minuit chiné

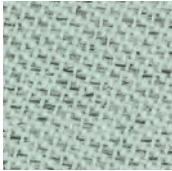

BJ
Opaline chiné

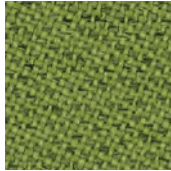

BK
Vert olive chiné

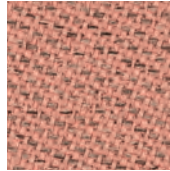

BL
Saumon chiné

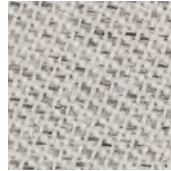

BM
Beige chiné

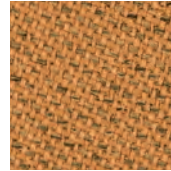

BO
Curcuma chiné

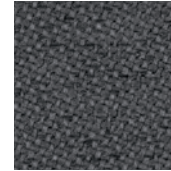

BN
Chocolat chiné

Step/Step Mélange (Cat. B)

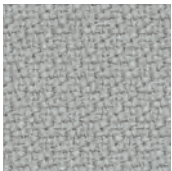

E5
Gris clair



A6
Noir

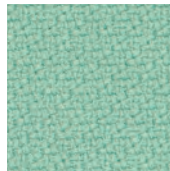

E4
Vert d'eau

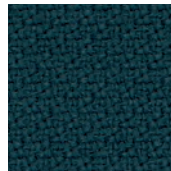

A4
Bleu pétrole

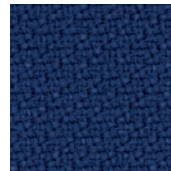

A3
Bleu marine

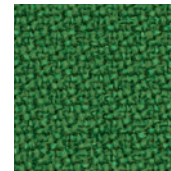

A1
Bambou

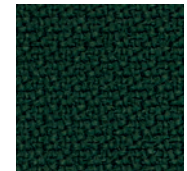

A9
Vert anglais

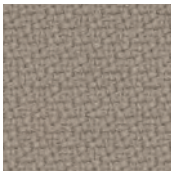

A2
Beige

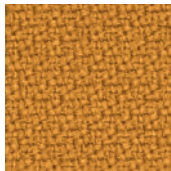

A5
Jaune moutarde



E6
Tomette

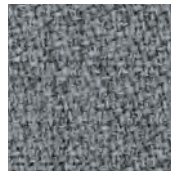

B5
Gris clair chiné



B1
Anthracite chiné



E7
Vert d'eau chiné



B4
Bleu denim chiné



B6
Marine chiné

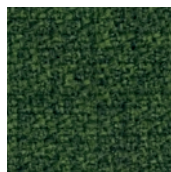

B2
Bambou chiné



E8
Vert olive chiné

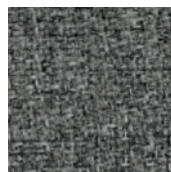

B3
Beige chiné



E9
Jaune moutarde
chiné

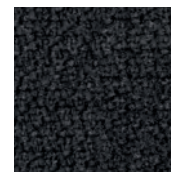

B7
Marron foncé chiné



Secret (Cat. C)



CA
Gris perle



CB
Noir

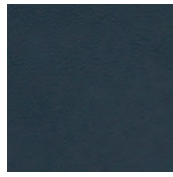

CC
Bleu minéral



CD
Noisette



CE
Vert olive



CF
Vert de gris foncé



CG
Argile



CH
Taupe

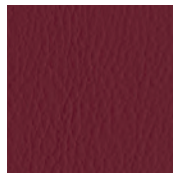

CI
Grenat

Fenice (Cat. D)

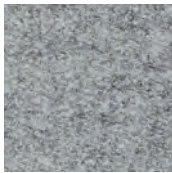

DA
Gris clair chiné

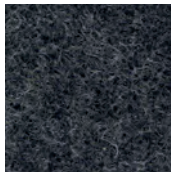

DB
Antracite chiné



CQ
Noir

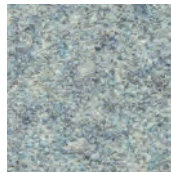

CJ
Bleu clair chiné

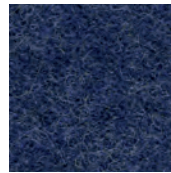

DC
Bleu foncé chiné

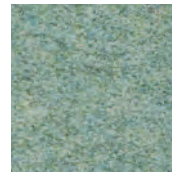

DF
Céladon chiné

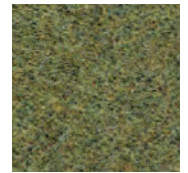

DE
Vert olive chiné

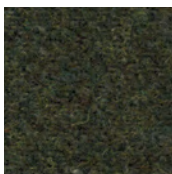

DG
Vert foncé chiné



DH
Rose poudré

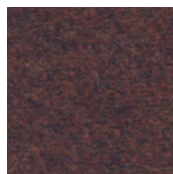

DZ
Terre de Sienne

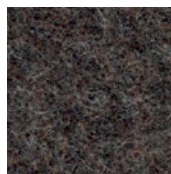

DD
Chocolat chiné



DI
Curcuma chiné



DJ
Rouille chiné

Vogue (Cat. D)



LA
Gris clair

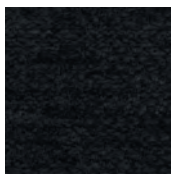

LB
Noir



LC
Vert olive

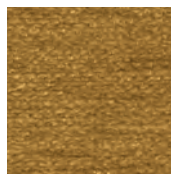

LD
Jaune moutarde

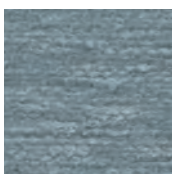

LE
Bleu horizon

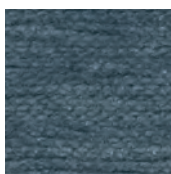

LF
Bleu fumé

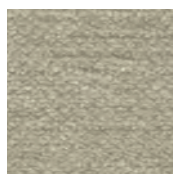

LG
Beige

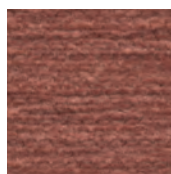

LH
Vieux rose

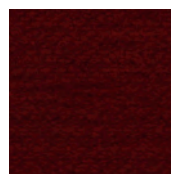

LI
Rouge bordeaux

Cuir (Cat. E)

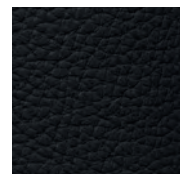

YB
Noir

TABLEAU DES FINITIONS



CONSULTER LE DÉTAIL
DES FINITIONS PAR GAMME
P.142 DU TARIF !





Caractéristiques techniques

Mélamine Stratifié Linoléum	Mélamine					Stratifié	Linoléum
	Epaisseur 19 mm		Epaisseur 25 mm	Epaisseur 30 mm	Epaisseur 38 mm	Epaisseur 23,6 mm	Epaisseur 20,6 mm
	Plateaux	Portes / Corps / Habillages	Plateaux	Plateaux	Plateaux	Plateaux	Plateaux
Revêtement double face, traité anti-reflets	✓	✓	✓	✓	✓	✓	Propriété antistatique
Finitions	MG - RI	Toutes	Toutes	MG - RI	MG - RI - N6 - M9	HZ - VW	LU - L1 - L2 - L4
Finition Noir velours MK Toucher velours, effet mat, bonne résistance aux traces de doigts : 3 couches de laque haute qualité	-	-	✓	-	-	-	-
Chants plats ABS anti-chocs et rayonnés ⁽¹⁾	✓	✓	✓	✓	✓	✓	Chants multiplis
Anti-bactérien (excepté le coloris Noir velours MK)	✓	✓	✓	✓	✓	✓ Traitement Sanitized®	✓
Densité ⁽²⁾	620 > 690 kg/m ³		600 > 670 kg/m ³	640 kg/m ³	630 kg/m ³	650 kg/m ³	750 kg/m ³
PEFC (issus de forêts gérées durablement)	✓	✓	✓	✓	✓	✓	✓
Certifiés E05 / E1 (conforme à la norme NF EN 717)	E05					E1	E1
Classement au feu (conforme à la norme NF EN 13501-1)	Classement M3 (D-S2,d0 EUROCLASS) pour tous les décors / M2 pour le décor blanc MG						
% moyen issu de matière recyclées (pré- et post-consommation)	68%. Les coloris R3, M9, N9, MK, N7, N8 sont certifiés CRADLE to CRADLE.					40%	28%
% recyclabilité	100%					100%	28%
Entretien	Passer un chiffon humide avec une eau savonneuse (doux sans peluche pour le linoléum et Noir velours MK). A éviter : produits abrasifs et détergeants.						

(1) Chants assortis au coloris du plateau excepté pour le coloris N8 (chants multiplis) et les plateaux stratifiés de la gamme Evasion
Chants ABS 2 mm (majoritairement) et 1 mm non rayonnés

(2) Densité : Tolérance +/- 10%



Caractéristiques techniques

Tissu	Composition	Poids du tissu	Nombre de tours d'abrasion	Tenue à la lumière	Résistance au frottement	Normes anti feu	Environnement
Bondaï Cat. A	100% polyester	350 g/ml (lm) 250 g/m ² ±5%	150 000 EN ISO 12947-2	6 EN ISO 105-B02	4-5 EN ISO 105 x 12 Mouillé-Sec	EN 1021 - 1&2 BS 7176 BS 5852 Crib5	STANDARD 100 by OEKO-TEX®
Chili Cat. B	100% polyester recyclé post-consommation fr (fr à l'intérieur de la fibre)	470 g/ml (lm) (15.16 oz / lin yd)	60 000 EN ISO 12947-2	5-8 EN ISO 105-B02	4-5 EN ISO 105 x 12 Mouillé-Sec	EN 1021 - 1&2 NFP 92-503/504/505 M1 NF D 60-013 AM18 BS 7176 BS 5852 Crib 5 DIN 4102 B1 EN 13501	STANDARD 100 by OEKO-TEX® Fibre 100% recyclé Basse émission de COV
Step Step Mélange Cat. B	100% trevira® CS	470 g/m ² (15.16 oz / lin yd)	100 000 EN ISO 12947-2	5-7 EN ISO 105-B02	4-5 EN ISO 105 x 12 Mouillé-Sec	EN 1021 - 1&2 NFP 92-503/504/505 M1 NF D 60-013 AM18 BS 7176 BS 5852 Crib 5 DIN 4102 B1 EN 13501	STANDARD 100 by OEKO-TEX® EU Ecolabel Teintures non métalliques Basse émission de COV
Secret Cat. C	76% PVC - 22% PES - 2% PU Protection antibactérienne	540 g/ml (lm) ±10 g/m ²	60 000 EN ISO 5470-2	6-7 EN ISO 105-B02	5-5 EN ISO 105 x 12 Mouillé-Sec	EN 1021 - 1&2 BS 5852 1&2 UNI 9175 class 1IM TB 117:2013	Sans Phtalates
Fenice Cat. D	75% Laine 25% PA	335 g/m ² ±7% 500 g/ml (lm) ±7%	100 000 ±20% EN ISO 5470-2	6 ±1% EN ISO 105-B02	4-5 EN ISO 105 x 12 Mouillé-Sec	EN 1021 - 1&2 BS 5852 Crib 5 CLASS 1 IM CALIFORNIA TB 117	Tissu recyclable
Vogue Cat. D	100% polyester trevira CS	700 g/ml (lm) 500 g/m ²	200 000 EN ISO 12947-2	6 EN ISO 105-B02	4-5 EN ISO 105 x 12 Mouillé-Sec	EN 1021 - 1&2 NFP 92-501-7 M1 NF D 60-013 AM18 BS 7176 BS 5852 Crib 5 DIN 4102 B1 CA UNI 9174 UNI 8456 CALIFORNIA TB 117 IMO for upholstery Part 8	STANDARD 100 by OEKO-TEX®

Index



A	Accessoires de bureau	273	L	Lampadaires	267
	Accessoires de réunion	273		Lampes de bureau	266
	Accessoires pour rail	121 - 123 - 129		LÉON	218
	ALTER	222		LINE	256
	ANTHRA+	249		LUCIE	202
	ARIAL Bureaux	106		LUCIEN	123
	ARIAL réunion	168		LUTZ 2	92
	ARIV	144			
	ARMAND	140	M	MANHATTAN	213
	Armoires démontables	148		MARGOT	28
	Armoires à rideaux	144-146		MARTIN	180
	ATTITUD	211		MEETING+	248
	AXEL 2	86		MELINA	130
				MIA	223
B	Banc	153 - 196		MODULO	164
	Banques d'accueil	42-48		MOKA	70
	Banquettes	22 - 28 - 184	N	NAVERT	146
	BIP	34			
	Boîtiers prises	279	O	Obturateurs	278
	Bras supports écrans	274		OPUS	215
	Bureaux mobiles	92 - 106		OSCAR	220
			P	Panneaux écrans	116 - 122 - 123
C	Câbles d'alimentation	279		PING	178
	Caissons mélamine	130 - 133		Portemanteaux - Patères	272
	Caissons mélamine éco	133		Poutres	54-55
	Caissons métal	134	R	Rayonnages	150 - 151
	CAMILLE	136		Rehausse	133
	Canapés	22 - 28 - 38 - 39		Repose-pieds	273
	CHATBOX	184		RIO	74
	CHEST	39		ROBIN bureaux	96
	Chevalet	273		ROBIN direction	78
	CLARA	201		ROBIN réunion	174
	Classeurs	149		ROMY	236
	Cloisons	116 - 122		ROSALIE chaises	246
	COACH ergo	214		ROSALIE poutres	55
	CONNECT	100	S	SCOTT	244
	Corbeilles de bureau	135 - 270 - 273		SEVEN	210
	Corbeilles de tri selectif	270		Sièges 24H Pro	226
				Sièges dessinateurs	216 - 220 - 227
E	ELIOTT	216		Sièges polyuréthane	227
	ELOISE	194		SOFIA	252
	ELTON	212 - 234		SOLANGE	116
	E-MEETING	176		SOSIE poutres	55
	EMI table	192		SPOON	260
	EMI chaises	240		Support clavier	277
	EVASION chaises	250		Support UC	277
	EVASION poutres	54	T	Tableaux	180 - 273
	EVASION tables	198		Tables à dégagement latéral	191
				Tables abattantes	188 - 192
F	FORSTYL	114		Tables basses	40
				Tables informatiques	277
G	GALWAY	38		Tables outdoor	202 - 203
	GELATI	258		Tables pliantes	193
	GEO	249		Tables polyvalentes	190
	Gestion des fluides	280		Tabourets multiusage	227
	GLOBE XXL	226		Tabourets	246 - 250 - 252 - 254 - 258 - 260 - 261
	GRETA	48		TARA	254
	Goulottes	281		TIC	261
	GUEST	42		TOM	224
	GUSTAVE	128		TOWERS	128
				Trappes	279
H	HARLY	213		TWINS	122
	Home office	82 - 92 - 220 - 234	V	Végétaux décoratifs	268
	HOMÈRE	82		Vestiaires	136 - 140 - 152 - 272
				Voiles de fond	281
I	IDOL	110	Z	ZÉLIE	22
	INVENTIV	232			
	IRIS	203			
	ISABEL	230			
J	JAMES	126			
K	KARA	64			
	KARL	60- 158			





Mobilier disponible sur stock
Livraison & installation rapides
eol-group.net