



EUROPEES
FABRIKANT
VAN KANTOOR-
MEUBILAIR



Collectie 2023 / 2024
eol-group.net

EOL

ontwerpt en vervaardigt meubelcollecties voor de inrichting van unieke werkomgevingen die bijdragen tot het welzijn van de werknemers

Frans design vormt de inspirerende rode draad door ons aanbod heen.
Functioneel, creatief en duurzaam. Leverbaar uit voorraad of personaliseerbaar op verzoek.



EOL MAAKT HET VERSCHIL OP 3 COMPETENTIENIVEAUS

Ontworpen en vervaardigd in eigen land

Wij beheersen alle vakgebieden
in het productieproces: hout- en
metaalbewerking, stoffering...

Inrichtingsadvies

Opdat uw meubilair perfect voldoet
aan de noden van uw bedrijf

Een gestructureerde en globale logistieke organisatie

Wij staan in voor de opslag, de levering
en de installatie van uw meubilair



+ 250
medewerkers



**2 productie-
vestigingen**
In Frankrijk



+ 7
meer dan 7 landen snel
beleverbaar uit voorraad
(FR, BENELUX, UK, IRL en CH)



20 000 m²
opslagruimte voor
afgewerkte producten

Concrete initiatieven voor duurzame ontwikkeling

Sinds 2017 houdt EOL in zijn strategie rekening met de uitdagingen van de klimaatverandering en het respect voor ons ecosysteem. Daartoe werden 30 ecologisch verantwoorde initiatieven opgezet.

In 2022 stemde EOL zijn bedrijfsvoering af op de duurzame ontwikkelingsdoelstellingen van de VN. Deze doelstellingen werden uitgewerkt in actieplannen voor de teams en de partners van EOL.

Op basis van een effectenanalyse van de activiteiten van EOL, werden 9 doelstellingen geselecteerd als prioritair in het vooruitzicht van 2025



Onze 9 vooruitgangsthema's voor duurzame ontwikkeling



GOEDE GEZONDHEID EN WELZIJN

- › Verminderen van de ernst/het aantal arbeidsongevallen
- › Gebruik van persoonlijke beschermingsmiddelen
- › Zwaar werk verminderen (investeringen in nieuwe machines voor de fabriek van EU)
- › Geen gebruik van CMR-stoffen of solventen
- › REACH-conform (Europese verordening inzake chemische producten)
- › Gebruik van OEKO-TEX schuimvullingen en stoffen (textielkwaliteitslabel)
- › Organisatie van telewerk voor ondersteunende functies



BETAALBARE EN DUURZAME ENERGIE

- › Vermindering van het gas- en elektriciteitsverbruik
- › LED-relamping in onze werkplaatsen
- › Elektrische heftoestellen
- › Herinjectering van warmte uit de houtbewerking
- › Investeringen in performantere machines
- › Transitie naar energiezuinigere processen
- › Verlaging van de temperatuur in de lokalen
- › Installatie van timersystemen op de verlichting
- › Optimalisering van de temperatuur in de droogoven



VERANTWOORDE CONSUMPTIE EN PRODUCTIE

- › Vermindering van het verbruik van grondstoffen en optimalisering van de productie-uitval (hout, metaal, textiel)
- › Gebruik van recyclebare materialen of op basis van gerecycleerde producten
- › Transitie naar alternatieve materialen met een lagere impact op het milieu
- › Besparing op verpakkingsmateriaal en gebruik van recyclebare verpakkingen
- › Hergebruik van primaire of secundaire verpakkingen (pallets, metalen kooien, hoekbeschermingen, stoelverpakkingen, ...)
- › Intermodulariteit van de onderdelen



EERLIJK WERK EN ECONOMISCHE GROEI

- › Vermindering van het aantal arbeidsongevallen
- › Beroep doen op sociale werkplaatsen
- › Lokale tewerkstelling
- › Aanwerving van personen met een beperking



GENDERGELIJKHEID

- › Verhouding mannen/vrouwen in de ondersteunende functies
- › Invoering van loonroosters om de verhouding verantwoordelijkheid/loon te objectiveren



SCHOON WATER EN SANITAIR

- › Vermindering van het waterverbruik (ontvettingscabine)
- › Waterlozing conform met de reglementering
- › Oppervlaktebehandeling met baden in omgekeerde cascade



MAATREGELEN IN DE STRIJD TEGEN DE KLIMAATVERANDERING

- › Beroep doen op vervoerders die het CO²-charter onderschrijven
- › Geoptimaliseerde belading
- › Vermindering van het aantal papieren catalogi. Transitie naar een digitaal aanbod



LEVEN OP HET LAND

- › Gebruik van hout met PEFC-certificering (biodiversiteit en strijd tegen de ontbossing)
- › Geen vervuiling (bodem, water, lucht) door de geldende reglementeringen na te leven



PARTNERSCHAP OM DOELSTELLINGEN TE BEREIKEN

- › Giften aan verenigingen
- › Actieve zoektocht naar industriële toeleveranciers van gerecycleerde onderdelen



Onze engagements

Onze strategie, onze dagelijkse activiteiten, ons gedrag, onze producten en diensten worden gedreven door sterke waarden met de volgende doelstellingen:

Het welzijn

van de gebruikers bevorderen

De kwaliteit

en de veiligheid van onze producten garanderen

Innovatie

centraal plaatsen in onze ambities

Een positieve impact

op de samenleving nastreven

ONZE FILOSOFIE

EEN AANBOD VOOR ELKE TOEPASSING

Wij plaatsen de gebruiker centraal in onze productontwikkeling en inrichtingsadviezen



Onze diensten: Globale oplossingen voor unieke projecten

Meer dan ooit is de inrichting van kantoorruimten een belangrijk aspect van prestatiebevorderend management. Met meer dan 30 jaar ervaring in de sector kunnen wij u begeleiden door alle fasen van uw project.



LUISTEREN

NODEN IN KAART BRENGEN

De perimeter van uw project bepalen

Uw uitdagingen en noden aflijnen

.....



ANALYSEREN

HET PROJECT MATERIALISEREN

Oplossingen uitwerken die aansluiten bij uw noden en budget

.....



FABRICAGE

IN EIGEN BEHEER

Kennis van verschillende vakgebieden: hout- en metaalbewerking, stoffering (2 fabrieken in de Bourgogne en Normandië)

Productie van standaardmeubilair of maatwerk voor volumeprojecten

.....

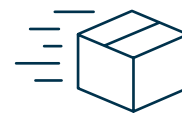

OPSLAG

SNELLE LEVERING

De meeste producten en de meest voorkomende afwerkingen zijn leverbaar uit voorraad

Follow-up in real time van de productbeschikbaarheid (EOL.net)

.....



INSPIREREN

TRENDS EN TOEKOMST

Maatschappelijke trends, gebruiken en nieuwe technologieën onderkennen

Corporate identity, stijluniversum en werksfeer

.....



INRICHTEN

INTEGRATIE EN BEGELEIDING

Integratie van de werkstromen en werkmethodes

Visualisering en 2D in 3D simulaties om te beslissen en te communiceren

.....



LEVEREN EN INSTALLEREN

LOGISTIEKE SERVICE OP MAAT

Levering van het meubilair, al dan niet met montage

12 degroupageplatformen, professionele installatieteams

.....



OPVOLGING EN KWALITEIT

NAVERKOOPSERVICE

Gecertificeerde producten onder garantie

Opvolging van het meubilairpark éénmaal in gebruik

.....

Inspiraties 2023-2024

Gevoel met de trends

Om u te begeleiden in de creatie van unieke werkomgevingen ontwikkelde onze designstudio 8 decoratieve stijlen. In elk van die stijlen worden de materialen en kleuren uit ons algemeen aanbod naar voren gebracht.



MA

Minimal

Eenvoud
Essentie
Sereniteit



DF

DH



MG

Green working

Natuurlijk
Bewust
Levend



RI

B2



B3

New classique

Traditie
Uitstraling
Soberheid

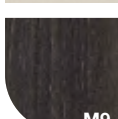
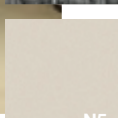
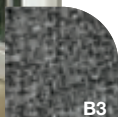

N5

M9



DI

Ocr'attitude

Aards
Natuurlijk
Warm



DJ

DZ

Focus op fluweelzacht zwart MK



Een fluweelzacht gevoel, hoge slijtvastheid



Een mat effect dat de ruimte meer uitstraling biedt



Toegepast in geselecteerde bureau- en vergadercollecties



All in black

Karakter
Diepgang
Elegantie

MK

LE

ZP



Néo rustique

Less but better
Zwart & hout
Archetype

R3

B5

SG



Oxygen

Oasegevoel
Frisheid
Zachtheid

N6

DF

A9



Cocoon

Uitgezuiverd
Rustgevend
Organisch

N5

ZC

BM

Werken in hybride modus: het nieuwe normaal

Een nieuw tijdperk is aangebroken

Nu 4 op 5* grote ondernemingen in Europa een hybride werkorganisatie hebben doorgevoerd, dienen zich nieuwe uitdagingen aan op het niveau van de inrichting van de werkomgeving.

WAARVOOR STAAT HYBRIDE WERKEN?

Het betekent dat de werktijd verdeeld wordt tussen fysiek aanwezig zijn op de werkvloer en werken vanop afstand (thuis of op een andere plek).



IN MIJN BUBBEL

Chatbox stiltecabines ter vervanging van de klassieke vergaderruimte.

Ze maken optimaal gebruik van de beschikbare ruimte en bieden medewerkers akoestisch comfort in een open space kantoor.

Om zich te concentreren, te telefoneren of te overleggen in alle vertrouwelijkheid.

› Chabox p. 184



NOMADISME NIEUWE STIJL

Gaande van zelfregelende stoelen tot rechtstreeks toegankelijke aansluitpunten. Medewerkers moeten zich kunnen connecteren en installeren zonder tijdverlies.

› Stoelen Elliott p. 116 - Oscar p. 220

› Nieuwe connectiekoplossingen p. 278

* Studie JLL "Het regenererende kantoor voor werknemers die zich duurzaam ontplooiën en engageren", uitgevoerd bij 3 500 werknemers wereldwijd.

DE UITDAGINGEN?

› Het accent op het collectieve:

Het gaat om veel meer dan het aanbieden van 'loungy' ruimtes, maar om het creëren van werkomgevingen waar maximaal rendement wordt gehaald uit de fysieke aanwezigheid van het team. Collectief, creatief en efficiënt.

› Motiverende werkomgeving*:

Welzijn in de ruimste betekenis. Het gaat erom de fysieke en mentale ontplooiing van de medewerkers te bevorderen en de basis te leggen voor teamprestaties.

› Flexibele inrichting:

Meubilair dat zich aanpast aan de omstandigheden en het aantal aanwezigen op een bepaald moment. Optimale benutting van de beschikbare ruimte zonder afbreuk te doen aan het comfort en het welzijn van de medewerkers.



COLLECTIEF RENDEMENT

Een omgeving creëren die uitnodigt om elkaar te ontmoeten, te overleggen en ideeën te delen op een ongedwongen manier.

Een bijkomende ontspanningsruimte met een Ping tafel om tussen 2 vergaderingen te bewegen en op adem te komen.

Ruimte om te herbronnen en de teamspirit te bevorderen.

› Margot p. 28

› Ping p. 178



FLEXIBELE INRICHTING

Een polyvalente ruimte met mobiele elementen die zich aanpast aan het projectteam.

Een ruimte die reserveerbaar is voor het projectteam en die na afloop weer wordt omgevormd tot flexplek.

› Arial mobiel p. 168 - Martin p. 180 - Solange p. 116

Richt uw kantoor in volgens uw eigen tijdsplanning

UIT VOORRAAD OF MAATWERK? OPLOSSINGEN DIE AANSLUITEN BIJ UW NODEN

Ons aanbod werd zodanig ontwikkeld dat het een antwoord kan bieden op de meest uiteenlopende inrichtingsprojecten en zich aanpast aan uw stijlvoorkeuren en tijdsplanning.

Vandaar dat wij u verschillende levertermijnen kunnen voorstellen afhankelijk van de gekozen producten en uitvoeringen.

UITVOERINGEN UIT VOORRAAD

Een ruim aanbod van producten en kleuren uit voorraad

LEVERING BINNEN
10 dagen

UITVOERINGEN MET LEVERTIJD

Een aanbod van producten en kleuren met levertijd

LEVERING BINNEN
4 tot 6 weken

MAATWERK

Wij passen ons meubilair aan uw uitgewerkte project aan (kleuren, afmetingen, ...)

LEVERING BINNEN
6 tot 8 weken

WAARVOOR STAAN DE PICTOGRAMMEN?



Productie in Frankrijk

Frans fabrikant



Productie in Europa

Europees fabrikant



Zelf te monteren stoel



Voorgemonteerde stoel (zit en rug gemonteerd, gaslift, poten en wielen nog te monteren) – Uitzonderd armleuningen



Stapelbare stoelen



Stapelbaar op transportwaggen

Een papieren catalogus of online informatie om uw leven eenvoudiger te maken

EEN ONTDEKKINGSTOCHT OFF LINE EN ON LINE

Onze catalogus staat synoniem voor een inspirerende ontdekkingstocht.
Voor meer informatie over een bepaald product scant u de bijbehorende QR-code.

Die biedt toegang tot gedetailleerde informatie:
beeldbank, technische fiches, kleurenkaart...

- 1 -

Kies

de producten die u
interesseren in de
catalogus



- 2 -

Scan

de QR-code

ALLE
INFORMATIE
ONLINE



- 3 -

Raadpleeg

de technische fiches en alle
bijkomende informatie op
de website



Kleurenkaart stoffen
Cat. A, B, C, D met levertijd.
Volledige kleurenkaart op pagina 284



Verwijzing naar de pagina's "connectiek"



Antibacterieel oppervlak voor alle melamine bladen, met
uitzondering van decor Fluweelzwart MK



Percentage gerecycled materiaal



Meubilair geschikt voor personen
met beperkte mobiliteit (PBM)

Inhoud

Lounge en receptieruimte 18

Moduleerbaar zitmeubilair	22
Receptiestoelen en zitbanken	28
Lage tafels	40
Ontvangstbalies	42
Zitbalken	54

Bureauruimte 56

Directiebureaus	58
Projectbureaus & privacy	80
Home office	82
Waarom een zit-sta bureau?	84
Zit/sta-bureaus	86
Vaste bureaus	96
Privacy	116
Opbergmeubilair	124
Opbergmodules	126
Tower & ladeblokken	128
Lockers	136
Kasten	140
Ander opbergmeubilair	149
Rekken	150
Garderobekasten	152

Vergaderruimten en gemeenschappelijke ruimten 154

Vergadertafels	158
Vrijdbaar presentatie meubel	180
Stiltecabines	184
Universele tafels	188
Restauranttafels	198

Zitmeubilair

204

Bureaustoelen

206

Het belang van een juiste zithouding

208

Directiestoelen

210

Ergonomische stoelen

214

Projectstoelen

222

Specifieke stoelen

224

Stoelen

228

Bezoekersstoelen

230

Universele stoelen

236

Restaurantstoelen

250

Accessoires & elektrificatie

262

Accessoires

264

Verlichting

266

Decoratieve planten

268

Sorteerafvalbakken

270

Kapstokken

272

Vergaderaccessoires

273

Bureau-accessoires

273

Schermhouders

274

Multimediamebuair

277

Elektrificatie

278

Connectiek

278

Kabelgeleiding & frontpanelen

279

Kleurenkaart

282





Lounge en receptieruimte





Lounge en receptie



Zélie

LOUNGE

MEETING

BRAINSTORMING

Pagina 22 ›

.....



Margot

LOUNGE

MEETING

Pagina 28 ›

.....



Bip

LOUNGE

Pagina 34 ›

.....



Lage tafels

LOUNGE

ONTHAAL

Pagina 40 ›

.....

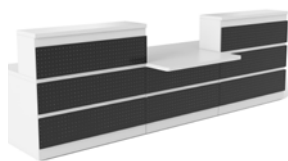

Guest

ONTHAAL

Pagina 42 ›

.....



Greta

ONTHAAL

Pagina 48 ›

.....



Galway

LOUNGE

Pagina 38 ›

.....



Chest

LOUNGE

Pagina 39 ›

.....



Évasion

ONTHAAL

Pagina 54 ›

.....



Rosalie

ONTHAAL

Pagina 55 ›

.....



Sosi

ONTHAAL

Pagina 55 ›

.....



Zélie

SPELEN MET VORMEN EN KLEUREN

Met zijn geometrische vormen voegt ZÉLIE een resoluut eigentijds accent toe aan de werkomgeving.

Productie
in Frankrijk

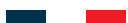



Hoekmodules, vierkante of rechthoekige modules, verrijdbaar of vast, de veelzijdigheid van ZÉLIE staat garant voor een unieke en comfortabele inrichting.





Dynamisch & modulair



Configureerbaar
1-, 2- of 3-zit, met of
zonder rugleuning

**Vast of
verrijdbaar**
Poef en zitbanken

Schrijfplateau
Makkelijk verplaatsbaar

Geconnecteerd
De connectiek is geïntegreerd
in de hoekmodule

Zoom



Hoekmodule
Met geïntegreerde connectie
1 stopcontact + 2 USB-A



Verrijdbaar
2 wielen achteraan



Koppelsysteem
Uittrekbaar



ZÉLIE samenstellen

Voorbeelden van opstellingen



Vergaderen

Het schrijfplateau voegt werkoppervlak toe en wordt makkelijk verplaatst



Brainstormen

In de verrijdbare versie wordt ZÉLIE naar wens opgesteld om te brainstormen



Overzicht

Zitmeubels zonder rug

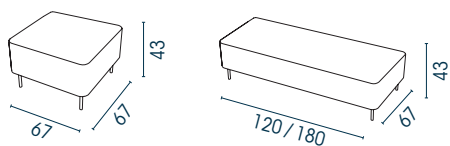

Koppelmodule

Met of zonder connectiek

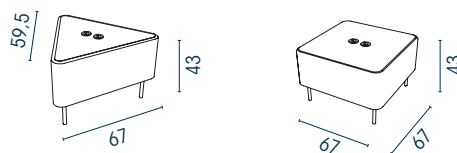

Zitmeubels met rug

Vast

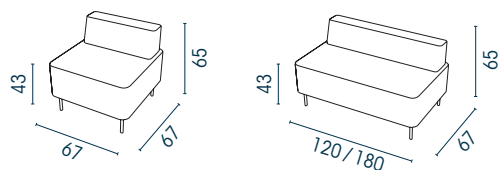

Vrijdbaar

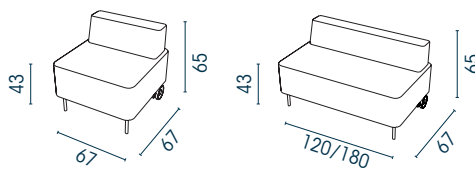

Poef

Vast of vrijdbaar

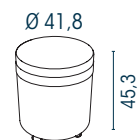

Lage tafels

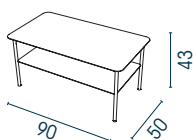
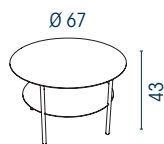

Schrijfplateaus

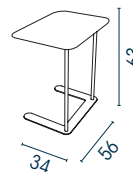
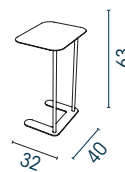

Kleurenkaart

Stof

Zit en rug



Cat. A
BONDAÏ



Cat. B
STEP
STEP MÉLANGE
CHILI



Cat. C
SECRET



Cat. D
FENICE
VOGUE

Metaal

Poten, tafels



SO



SG



ZO
Gestructureerd



SC



Onthaal

S-vorm

De hoekmodule biedt originele mogelijkheden

Lounge

Dankzij de hoekmodules en het zitcomfort zijn er oneindige zitoplossingen

PRIJSLIJST P. 6

Details en levertijden

**ALLE INFORMATIE
ONLINE!**





Margot

ART DE VIVRE

MARGOT geeft een verfijnde invulling aan de werkomgeving. De gedurfde vormen, waarbij comfortabel gevulde kussen worden gecombineerd met de zuivere lijnen van het onderstel, levert een unieke elegantie op.

Productie
in Frankrijk





Een expressieve stijl die functionaliteit niet in de weg staat. In de zittingen zijn stopcontacten geïntegreerd. Dit maakt het meubilair geschikt voor zowel receptieruimtes als informele vergaderruimtes.



Stopcontact
Links en rechts



Onderstel
Hout of metaal



**Draaibaar
schrijfplateau**
Melamine of
linoleum



Modern & expressief



Veelzijdig

De zitmeubels, met of zonder wanden, zijn bijzonder veelzijdig in gebruik: als vrijstaand zitmeubel, in wachruimtes, ontspanningsruimtes of informele vergaderruimtes (Box voor 2 of 4 personen)



Geconnecteerd

Zitmodules en tafels zijn uitgerust met connectiek (Stopcontact + USB-A)



Verfijnde afwerking

De vormen worden geaccentueerd met een elegant biesje





MARGOT samenstellen

Voorbeelden van opstellingen



Ontspannen

Versie met lage rug

Ideaal voor een zithoek in een directiekantoor, ontspanningsruimte of receptie



Ontvangen

Hoge rug als ruimte-indeling

Met de hoge versies kunnen open ruimten of doorgangen afgebakend worden



Overzicht

Fauteuils en 2-zits bank

Lage rug
Met of zonder connectiek

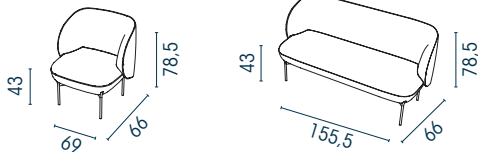

Hoge rug
Met of zonder connectiek

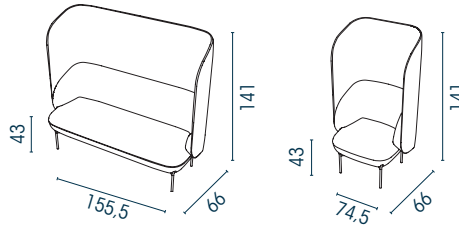

Wanden met tafel

Met connectiek

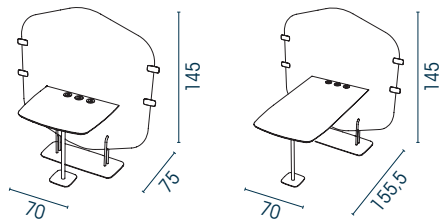

Méridienne

Met of zonder connectiek

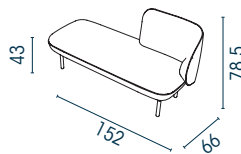

Tafels

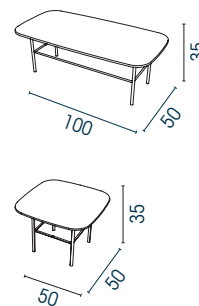

Poef

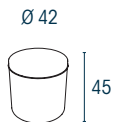

Accessoires

Schrijf-
plateau

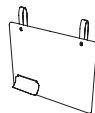

Stoffen hoofd-
steun of kussent



Draaibaar
schrijfplateau



Connectiek



Concentreren

Bank met hoge rug

Om ongestoord te werken



Onthaal

Voor 2 of 4 personen

Spelen met de hoogtes
Hoge versie om open ruimtes
of circulatie zones af te bakenen

Kleuren- kaart

Stof

Zit en rug



Cat. B
STEP
STEP MÉLANGE
CHILI



Cat. C
SECRET



Cat. D
FENICE
VOGUE

Metaal

Poten, tafels



SO



SG



ZO



SC

Gestructureerd

Metaal / Hout

Poten zitmeubilair



ZOMS



SUMS



ZPMS

Linoleum

Bladdikte 20,6 mm



LU

PRIJSLIJST P. 7

Details en levertijden

ALLE INFORMATIE
ONLINE!





Bip

RUIME VORMEN VOOR OPTIMAAL COMFORT

BIP staat voor eigentijdse zitmeubels met een omhullende en comfortabele kuip.





Vast of draaibaar, diverse pootversies, BIP is zowel geschikt voor de receptieruimte als voor de ontspanningsruimte of de vergaderruimte



Specifieke kleurenkaart

Stof EVO Cat. A



TS
Zwart

TH
Muisgrijs

Kunstleder VALENCIA Cat. C



F1
Parelgrijs

F2
Grijs

F3
Zwart

F4
Marineblauw

F5
Maisgeel

F6
Olijfgroen

F7
Terracotta

F8
Graanaat

F9
Beige

Stof STEP Cat. B



A1
Bamboe

A2
Beige

A3
Marineblauw

A4
Petroleumblauw

A5
Mosterdgeel

A6
Zwart

A9
Engels groen

E4
Watergroen

E5
Lichtgrijs

E6
Tomette



Ruim & comfortabel



Zitmeubels voor elke toepassing

Verschillende pootversies: spinonderstel, 4 poten, draaibaar of in hoogte verstelbaar

Zitmeubels voor elke ruimte

Onthaal, ontspannen, vergaderen

Afgeronde lijnen

Omhullende zit

Contrasterend stiksel

Voor een unieke stijl

Verrijdbaar

Wielen voor harde of zachte vloeren

Stof SYNERGIE Cat. C



Q1
Gespijkeld licht beige



Q2
Gespijkeld bruin



Q3
Gespijkeld rookgrijs



Q4
Gespijkeld antraciet



Q6
Gespijkeld koraal



Q7
Gespijkeld zalmroze



G1
Gespijkeld donkerblauw



Witte stiksels voor zwarte kleuren (TS, A6, F3, YB).
Zwarte stiksels voor alle andere kleuren.

Leder Cat. E



G2
Gespijkeld chocolade



G3
Donker celadon



G4
Watergroen



YB
Zwart



Y1
Taupe

PRIJSLIJST P. 10
Détails en levertijden
ALLE INFORMATIE ONLINE!





GALWAY



Een tijdloze klassieker met strakke lijnen



Stevig zitcomfort



Brandwerende versie (schuimvulling en stof Mirage)

Specifieke kleurenkaart

Kunstleder Inca, Cat. A



EG
Zwart



EH
Lichtgrijs



EI
Zand



EJ
Beige



EK
Donkergroen



EL
Marineblauw



EM
Bordeaux



EN
Pompoen

Brandwerende stof Mirage, Cat. B



WA
Zwart



WB
Donkergrijs



WD
Lichtgrijs



WE
Beige



WF
Lichtgroen



WG
Navy blauw

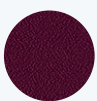

WH
Pruim



WI
Oranje

Leder Cat. E



YB
Zwart



PRIJSLIJST P. 11
Détails en levertijden
**ALLE INFORMATIE
ONLINE!**





CHEST



Zachte en afgeronde lijnen
voor een omhullend comfort

Voorzien van 5 steldoppen
om oneffenheden in de vloer te
compenseren

Specifieke kleurenkaart

Stof Bondai, Cat. A



KZ
Rood



KE
Zwart



K2
Marineblauw



KD
Wolkgrijs



KA
Stormgrijs

Kunstleder, Cat. B



YA
Zwart



PRIJSLIJST P. 11
Détails en levertijden

**ALLE INFORMATIE
ONLINE!**





Lage tafels

IN ALLE STIJLEN EN VORMEN

Een ruim en gevarieerd aanbod voor alle omgevingen: van klassiek of minimalistisch tot uitgesproken eigentijds. In hout, metaal of linoleum, om te werken of gewoon een koffie te drinken, voor elke toepassing een tafel!

Productie
in Frankrijk



Behalve BIP



Behalve ZELIE



Behalve BIP,
ZELIE



5
jaar



MARGOT

43 %



H.35 x B.100 x D.50 cm

ZÉLIE

55 %



H.43 x B.90 x D.50 cm

ÉVASION

19 %



H.48 Ø60 cm



H.35 x B.50 x D.50 cm



H.43 Ø67 cm



H.63 x B.40 x D.32 cm



H.63 x B.56 x D.34 cm

SUSHI

33 %



H.32 x B.60 x D.60 cm

STAR

34 %



H.45 x B.60 x D.60 cm

PURE

23 %



H.43 x B.76 x D.59 cm



H.32 x B.110 x D.70 cm



H.45 Ø75 cm

PRIJSLIJST P. 12
Détails en levertijden
ALLE INFORMATIE
ONLINE!





Guest

PERSONALISEER UW RECEPTIE!

GUEST is een volledig personaliseerbare ontvangstbalie.

Productie
in Frankrijk



Antibacterieel
oppervlak





Met de verschillende modules, de ruime keuze uit afwerkingen en de 4 frontbekleding en stelt u met GUEST een unieke ontvangstruimte samen.



Connectiek



<
**Standaard
kabeldoppen**
 (behalve modules
PBM)



<
**Met of zonder
uitsparing**
 (computer-schermen
tot 22 inch)



<
Metalen goot
 Voor
kabelgeleiding
 (optie)



Moduleerbaar & personaliseerbaar

Bekleding

Hout of metaal
(4 decors naar keuze)



Melamine

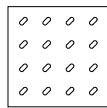

Schuin

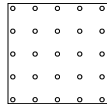

Punten

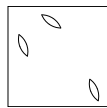

Blaadjes

Decoratieve elementen



Neutraal topblad



Topblad met boodschap + optionele ledkit, wit of gekleurd

Decoratief

Structuur en paneelpoten in wit melamine, aan te kleden met decoratieve elementen naar keuze

Configuraties voor elke toepassing

4 modules die naar wens kunnen gecombineerd worden

Gebruikerscomfort

Aangepaste tussenpoten voor maximale beenruimte





GUEST samenstellen

Voorbeelden van opstellingen



Gesloten balie

De 2 hoekmodules, links en rechts, voegen privacy toe voor de gebruikers en bieden altijd een opgeruimde indruk voor de bezoekers



Open balie

Door een PBM module aan het uiteinde of in het midden toe te voegen kan er zowel zittend als staand gewerkt worden



OVERZICHT

Lage module

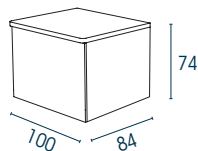

Hoge module

Met of zonder uitsparing
(B.120 en 160)

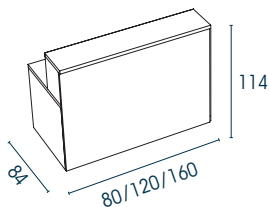

Hoekmodule

90° R of L

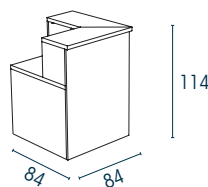

PBM Modules

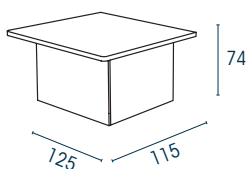
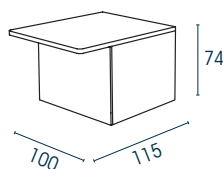

Bekledingen

(Voor elke balie moet een bekleding
besteld worden)

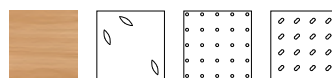

Kleuren- kaart

Melamine

Bladdikte 38 mm

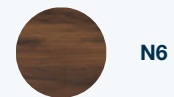
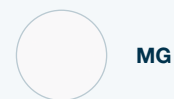

Melamine

Bekleding dikte 19 mm

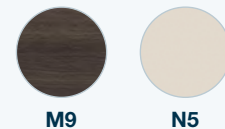
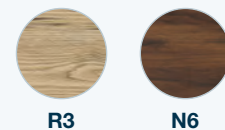
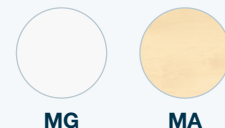

Metaal

Bekleding

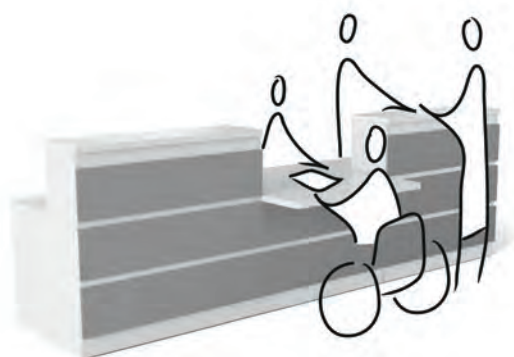
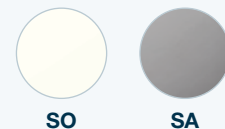

Aangepast

Voeg modules toe om een extra
ruime balie samen te stellen

PRIJSLIJST P. 13

Details en levertijden

**ALLE INFORMATIE
ONLINE!**





Greta

ALTIJD DE GESCHIKTE ONTVANGSTBALIE

Met de diverse modules en het bijbehorende opbergmeubilair creëert u met GRETA de perfecte receptieruimte. De decoratieve front- en zijpanelen voegen een elegante uitstraling toe.

Productie
in Frankrijk



Antibacterieel
oppervlak





De functionele bladen en opbergmeubels hebben uitsparingen voor discrete kabelgeleiding.

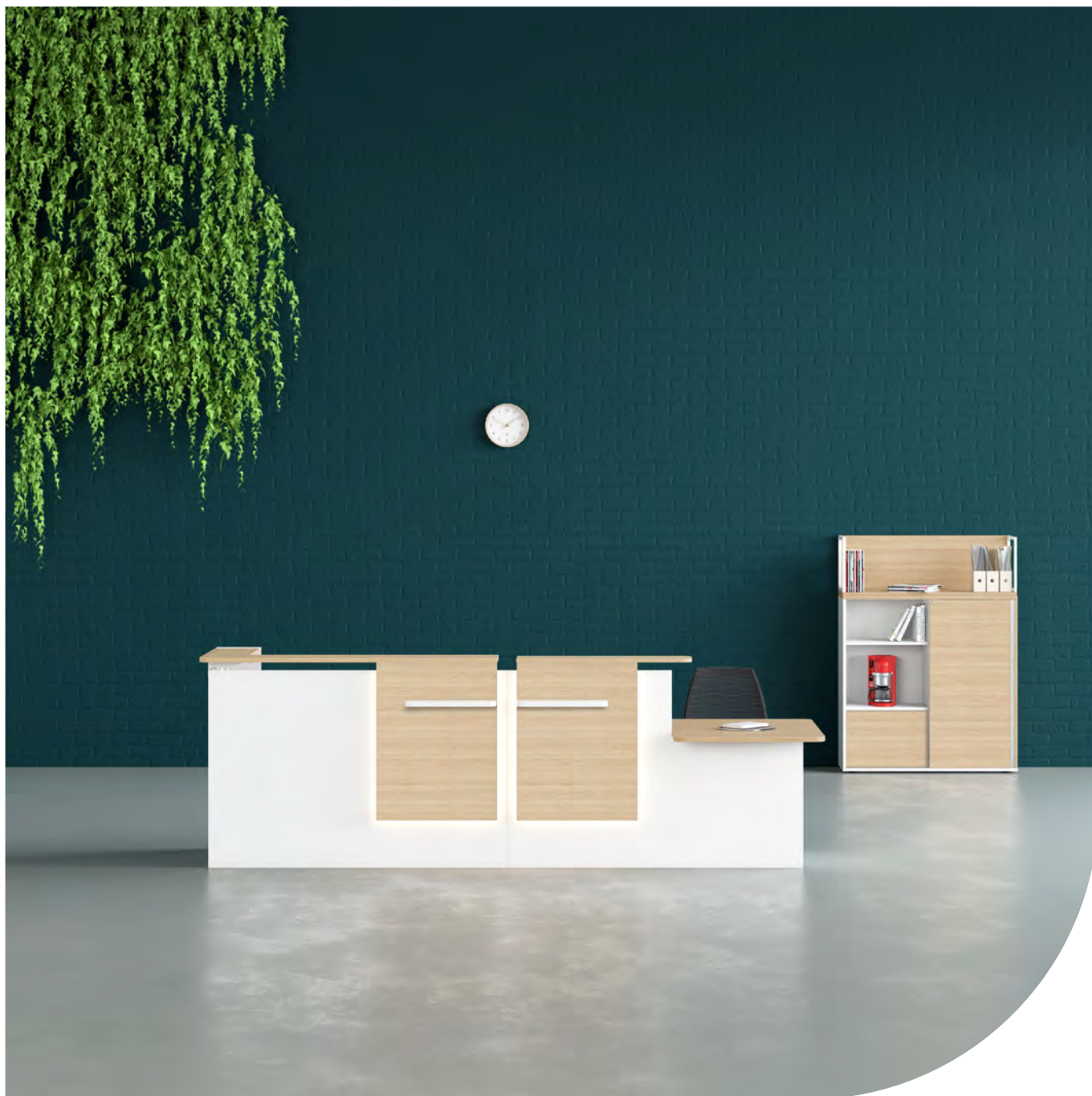

Zoom



Ergonomie voor de gebruiker Blad met uitsparing voor computerschermen tot 21 inch

Opties



Discrete kabelgeleiding Geïntegreerde uitsparing onderaan in de opbergmeubels



Ledkit Wit of gekleurd (wordt achter de frontbekleding geplaatst)



Lade Voor hangmappen (optie)



Compleet & functioneel

Ontvangstbalie

Met compacte afmetingen



Frontpaneel

Met handtasplateau

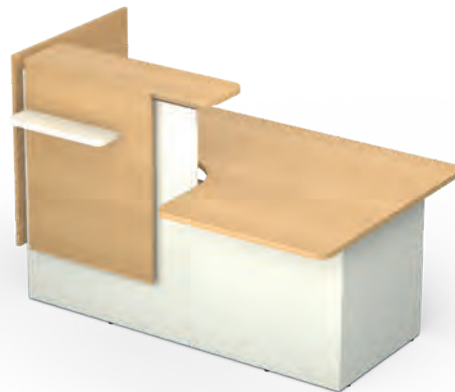

Decoratieve panelen

Structuur van wit melamine waarop frontpanelen (optie) of zijpanelen worden aangebracht. Bekleding in de kleur van de bladen

Module PBM

Aangepast voor personen met beperkte mobiliteit

Bijpassend opbergmeubilair

- Topblad voorgeboord voor optionele kabeldop
- Met schuifdeur
- + geïntegreerd slot
- Optie: hangmappenlade



GRETA samenstellen



Voorbeelden van opstellingen



Hoekbalie

Ontvangstbalie met een hoekmodule rechts en een eindmodule PBM links



Geïntegreerd opbergmeubilair

Door opbergmeubilair toe te voegen creëert u:

- Extra opbergruimte aan de gebruikerszijde
- Ruimte om bedrijfsdocumentatie aan te bieden aan de bezoekerzijde



Overzicht

Hoge module

Hoekmodule

- Zittend onthaal
- Werkblad H 73.5 cm

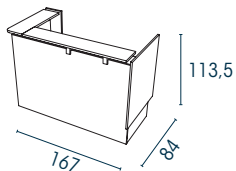

Rechte module

- Zittend onthaal
- Werkblad H 73.5 cm

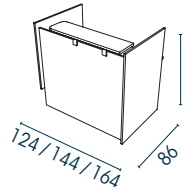

- Staand onthaal
- Werkblad H 95 cm

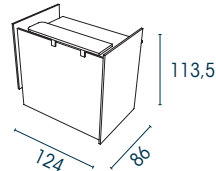

Module PBM

Zittend/staand onthaal

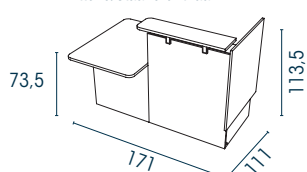

Zittend onthaal

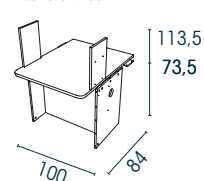

Opbergmeubilair

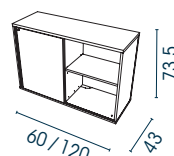
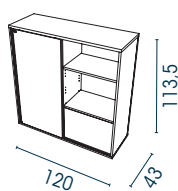

Opties

Lade

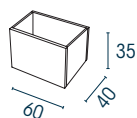

Te plaatsen of aan een muur te bevestigen legbord

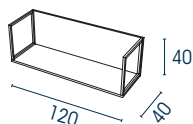

Frontbekleding

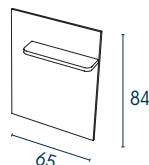

Kleuren-kaart

Melamine

Structuur balie dikte 25 mm
Ombouw kasten 19mm



MG



MG



RI



R3



N6



M9



N5

Zij - en frontpanelen 19mm dikte



Aangepast

Door een module PBM toe te voegen aan het uiteinde of in het midden creëert u een zittend of staand onthaal

PRIJSLIJST P. 15

Details en levertijden

ALLE INFORMATIE ONLINE!





Evasion

+ Modern & warm



Een eigentijds design met zitschalen van gelaagd beuken

Voor een warm en modern onthaal

De poot steekt uit achter de zitschalen

(voorkomt wrijving tegen de muur)

De plaats van de zitschalen en tussentafels kan vrij gekozen worden

Poten van geborsteld aluminium

Kleurenkaart

Multiplex beuken

Zitschalen



VK
Wit



VM
Zwart

Metaal

Draagbalk



SB
Aluminium



SG
Zwart

Productie
in Frankrijk



PRIJSLIJST P. 17
Détails en levertijden

**ALLE INFORMATIE
ONLINE!**





Rosalie



De poot steekt voorbij de zitschalen
(vermijdt wrijving tegen de muur)

4 kleuren naar keuze
Voor een onthaal in stijl

Omhullende en comfortabele zitschaal

Afwasbare zitschaal
(polypropyleen)

Plaats van de zitschalen en tussentafel
vrij te kiezen

Poten van geborsteld aluminium

Productie
in Frankrijk



Sosi



Afwasbare en slijtvaste schaal
(metalen zit en rug)

Draagbalk met of zonder tussentafeltje

De zitschalen en tussentafeltje kunnen naar
keuze worden gemonteerd

Vloerbevestiging op aanvraag
(vraag inlichtingen)



Kleuren- kaart

Polypropyleen
Zit



PS
Crème wit



PQ
Grijs



PJ
Geel



PR
Zwart

Metalen
Draagbalk



SB
Aluminium



SG
Zwart

PRIJSLIJST P. 17

Details en levertijden

**ALLE INFORMATIE
ONLINE!**



Kleuren- kaart

Metalen
Draagbalk



SB
Aluminium



SG
Zwart

PRIJSLIJST P. 17

Details en levertijden

**ALLE INFORMATIE
ONLINE!**







Bureauruimte







Directiebureaus



Karl
Elegant & Hoogwaardig

Pagina 60 ›

.....



Kara
Statig & Compleet

Pagina 64 ›

.....



Moka
Tijdloos & Functioneel

Pagina 70 ›

.....



Rio
Modern & sober

Pagina 74 ›

.....



Robin
Trendy & Naturel

Pagina 78 ›

.....



Karl

ELEGANTIE EN UITSTRALING!

KARL valt op met zijn elegante design en hoogwaardige materialen. De strakke lijnen voegen een aparte stijl toe aan het managementkantoor. Leverbaar in standaard melamine, linoleum of zwart melamine met fluweelstructuur. Slijtvaste bladen met een soft touch textuur maken een duurzaam verschil.

Productie
in Frankrijk

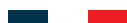



Voor managers die inzetten op teamwerk is er de vierkante tafel waaraan gewerkt of vergaderd kan worden.





Overzicht

Individuele bureaus

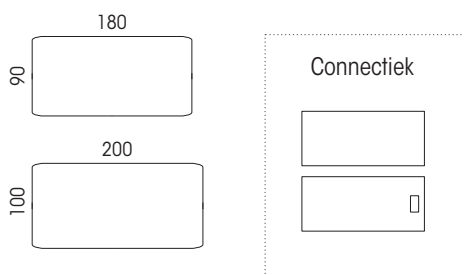

Bureaus / Vergadertafels

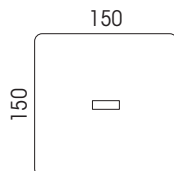

Opbergmeubilair

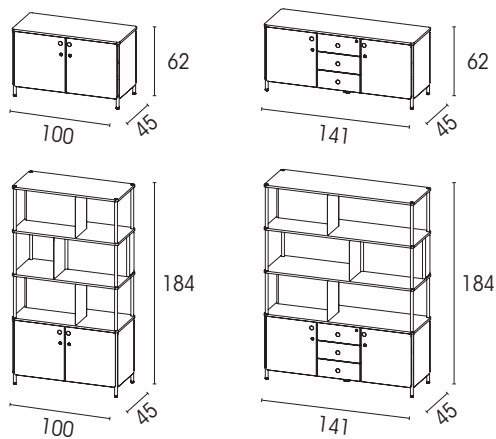

KARL bestaat ook in versie vergadertafels, zie p. 158



Elegant & Hoogwaardig



Elegante uitstraling

Zachte vormen en hoogwaardige materialen (massief eiken poten)

Zachte en unieke texturen

Naar keuze,

- Slijtvaste fluweelstructuur met melamine MK
- Zacht aanvoelend, mat oppervlak van linoleum (meer kleuren, zie p. 285)

Discrete kabelgeleiding

Kabeldoorgangen geïntegreerd in het onderstel. Technisch luik in de kleur van het blad

Kleurenkaart

Melamine

Bladdikte. 25 mm, topblad wandmeubels



N5



MK
Fluweelzwart melamine

Topblad wandmeubel en legborden



RI

Linoleum

Bladdikte. 20,6 mm



LU

Massief hout

Bureauonderstel



CM

Metaal

Bureaustructuur, structuur hoog opbouwmeubel, deuren en frontpaneel



ZP



ZC



Zoom



Poot met kabelgeleiding

De kabels zijn toegankelijk dmv vast te schroeven plaatje, enkel voor versie met softclosing



Softclosing luik tweezijdige toegang

In de kleur van het blad

PRIJSLIJST P. 20

Details en levertijden

ALLE INFORMATIE ONLINE!





Kara

FUNCTIONALITEIT EN ELEGANTIE HAND IN HAND

KARA valt vooral op met zijn robuuste werkbladen en tijdloze lijnen. De dragende aanbouwblad biedt extra oppervlakte.

Productie
in Frankrijk





Met het bijpassende opbergmeubilair wordt het managementkantoor compleet.



Ladeblok
2 of 3 laden



Lage kasten



**Wandkast met
vakken en deuren**

Naar keuze:

- Met draai-en/of schuifdeuren
- Met of zonder ladeblok



Statig & Compleet

Klassevol

Strakke vormen en een robuust blad geven extra karakter aan het managementkantoor

.....

Compleet

Gevarieerde samenstellingen en bijpassend opbergmeubilair

.....

Afwerkingsdetails

Ladeblok en aanbouwwand, met of zonder glazen topblad

.....

Discrete kabelgeleiding

Het bureaublad en de aanbouwwand zijn voorgeboord voor kabeldoppen

.....





KARA samenstellingen



Diverse mogelijkheden voor de aanbouw!

.....

Met een dragend ladeblok voor extra oppervlakte en opbergmogelijkheden binnen handbereik

.....

Aanbouw in lijn voor een optimale benutting van de beschikbare ruimte

.....

Met overstekende aanbouw voor extra oppervlakte en een volledig vrij bureau



Overzicht

Individuele bureaus

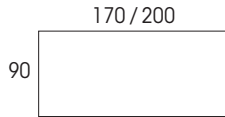

Bureaus met aanbouw

In lijn

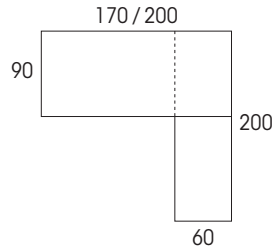

Overstekend

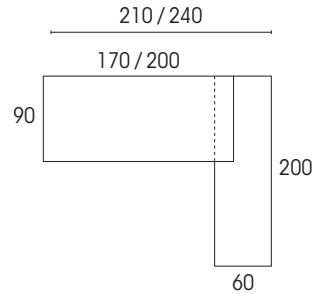

Bureaus met dragend ladenlok

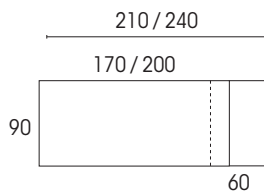

Bureaus met aanbouwen dragend ladeblok

In lijn

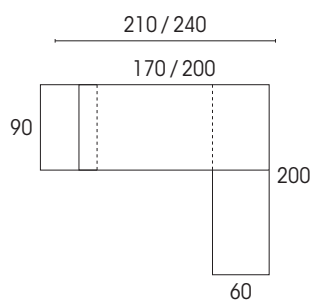

Overstekend

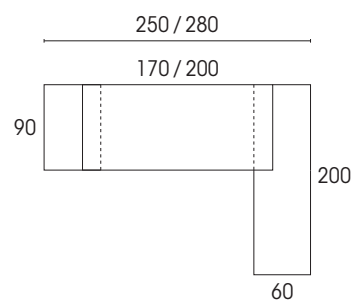

Opbergmeubilair

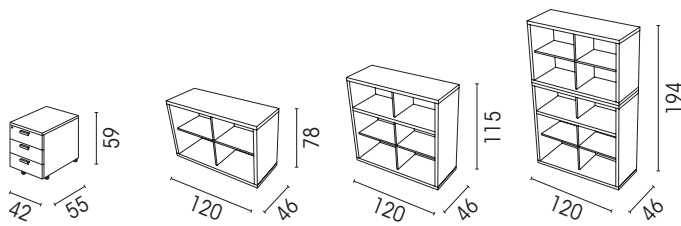

Opbergmeubilair, open of gesloten: verschillende indelingen leverbaar, zie prijslijst

Connektiek (voor melamine blad)

Bureaus

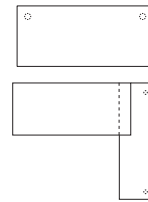

Kleuren- kaart

Melamine

Bladdikte
38mm, onderstel,
aanbouw en ladeblok



RI



N6



M9

Glas

Topblad ladeblok,
aanbouw, dikte 6mm



GS



Nog meer opbergmeubilair;
zie ARMAND p. 140

PRIJSLIJST P. 21

Details en levertijden

**ALLE INFORMATIE
ONLINE!**



Moka

DE TIJDLOZE KLASSIEKER!

MOKA is een klassieker binnen ons aanbod van directiemeubilair. De paneelpoten met een tussenregel voegen allure toe aan het geheel.

Productie
in Frankrijk



Antibacterieel
oppervlak



De slimme aanbouw biedt bijkomende opbergmogelijkheden en vergroot het werkoppervlak. De schuifdeuren van de aanbouw kunnen naar keuze naar binnen of buiten toe worden geplaatst.



Overzicht

Vrijstaande bureau

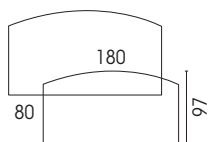

Opbergmeubilair

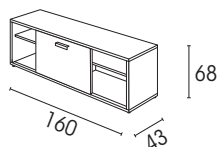

Bureaus met dragende aanbouw

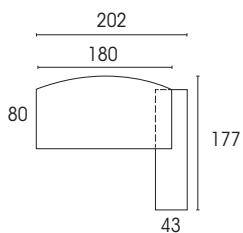
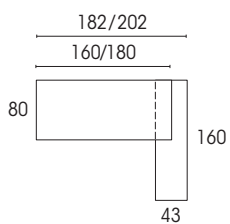

Samengestelde bureaus

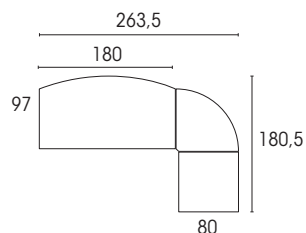
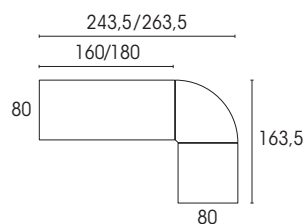

Koppelblad

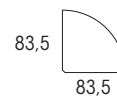

Connectiek

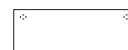

 Nog meer opbergmogelijkheden, zie ARMAND p. 140



Tijdloos & functioneel



Kleuren- kaart

Melamine
Bladdikte 25 mm
paneelpoten,
opbergmeubilair



RI



N6



M9

Schuifdeur van het
opbergmeubel altijd
in N5



N5

Opstellingen

Met aanbouw op dragend
opbergmeubel of panoramisch
bureau

Structureel frontpaneel

Met perforaties bovenaan
voor kabeldoorgangen

Kabeleleiding

Bladen voorgeboord voor
kabeldoppen (optie)

Dragende aanbouw



Deur open

Aan gebruikerszijde



Aan bezoekerszijde

PRIJSLIJST P. 24

Details en levertijden

**ALLE INFORMATIE
ONLINE!**





Rio

GLANZEND EN LICHT!

Met zijn sobere en eigentijdse uitstraling leent RIO zich zowel voor open werkomgevingen als voor het individuele kantoor. In de glazen versie voegt het glans en licht toe.

Productie
in Frankrijk





Diverse opstellingen: met of zonder aanbouw, glazen of melamine blad, RIO past zich aan elke werkomgeving aan.



Overzicht

Vrijstaande bureaus

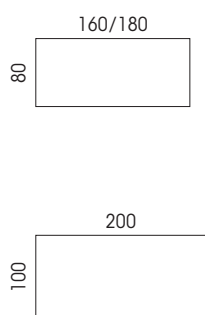

Bureaus met dragend opbergmeubel

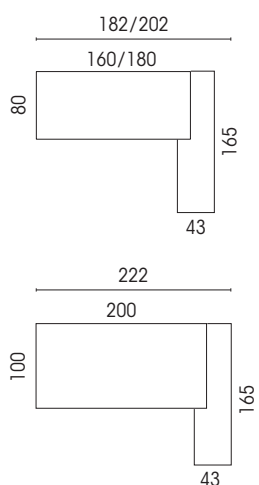

Bureaus met aanbouwblad

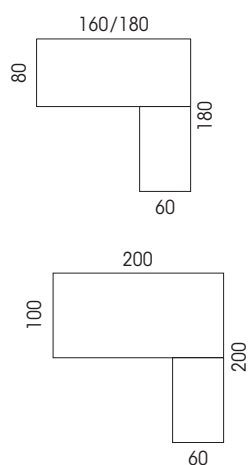

Connectiek

Voor melamine bureaubladen

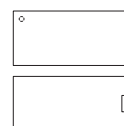

Voor vergadertafels



Aanbouwblad

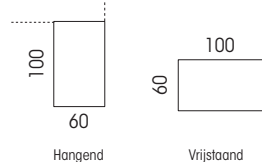

Vergadertafels

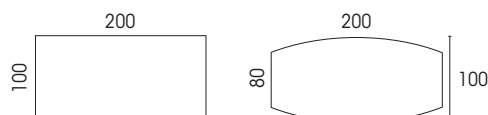



Modern & sober



Tijdloos design

Portaalpoot met rechthoekige doorsnede-(60 x 30 mm)

Elegant

Zwevend effect doordat het blad iets hoger is gemonteerd

Connectiek

Kabeldoppen of technisch luik

3 typesaanbouw



Met dragend
aanbouwmeubel



Hangend



Vrijstaand

Kleuren- kaart

Melamine

Bladdikte 25 mm



RI



R3



N6



MK
Zwart
melamine
met fluweel-
structuur

Glas

Bladdikte 8mm



GS

Metaal

Onderstel



SO



SA



SG

Altuglas

Schuifdeur aan
gebruikerszijde



OA

PRIJSLIJST P. 26

Details en levertijden

**ALLE INFORMATIE
ONLINE!**





Robin



2 posities voor het
aanbouwmeubel



Overstekend



In lijn



Optie



Hangmappenlade
Opent met een
druk op de lade

Productie
in Frankrijk

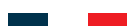

Antibacterieel
oppervlak





Trendy & Naturel



Eigentijds design

Houten poot. Voegt warmte en een zachte uitstraling toe aan het managementbureau

Veilig opbergen

Deur met vouwsleutel

Kabelgeleiding

Kabeldoppen of technisch luik aan de zijkant. Verticale kabelgeleiding door het dragend opbergmeubel

Overzicht

Vrijstaande bureaus

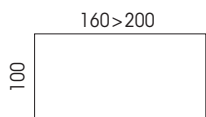

Bureaus met dragend opbergmeubel

In lijn

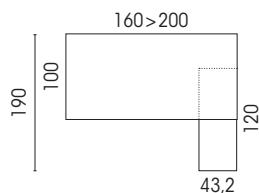

Overstekend

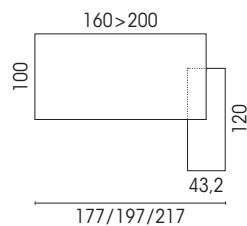

Connectiek

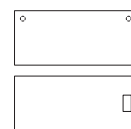

(kan rechts of links geplaatst worden)



Bestaat ook in co-working versie, zie p.96 en in versie vergadertafel, zie P.174

Kleurenkaart

Melamine

Bladdikte 25mm, ombouw van de opbergmeubels(schuifdeur passend bij het blad)



MG



N5



RI



MK/N9*

*Zwart melamine met fluweelstructuurMK voor de horizontale oppervlakken (verticale oppervlakken in N9 zwart melamine)

Metaal

Onderstel (handgreep passend bij de dwarsbalk)



SO



SG

Hout

Onderstel



MS

PRIJSLIJST P. 28

Details en levertijden

ALLE INFORMATIE ONLINE!





Bureauruimte & privacy-panelen en scheidingswanden



Homère
Draaibaar blad

HOME OFFICE

Pagina 82 ›



Axel 2 **NIEUW**
I-poot
Elektrisch of hendel

ZIT/STA-BUREAU

Pagina 86 ›



Lutz 2 **NIEUW**
I onderstel
elektrisch

ZIT/STA-BUREAU

Pagina 92 ›



Robin
4 houten
poten

BUREAUS

Pagina 96 ›



Conect
Bridge of
frame poot

BUREAUS

Pagina 100 ›



Arial
Bridge poot
Vast, RH of op wielen

BUREAUS

Pagina 106 ›



Idol
L of I -poot

BUREAUS

Pagina 110 ›



Forstyl
L- of paneelpoot

BUREAUS

Pagina 114 ›



Solange

Schermen en
scheidingswanden

PRIVACY-PANELEN

Pagina 116 ›

.....



Twins

Schermen en
scheidingswanden

PRIVACY-PANELEN

Pagina 122 ›

.....

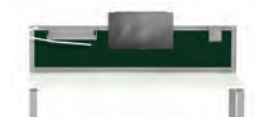

Lucien

Scherm met rail

PRIVACY-PANELEN

Pagina 123 ›

.....



Homère

Verrijdbaar

De wielen (waarvan 4 met rem) zijn geschikt voor alle vloertypes

Moduleerbaar

Draaibaar en uitschuifbaar blad

Praktisch

Opbergmeubel met vlakken en lade

Plaatsbesparend

Bepaalde vloeroppervlakte in ruststand

Productie
in Frankrijk



Antibacteriële
oppervlak





Het ideale bureau voor thuiswerkers!



Configuraties



Rustand

Gesloten positie met een
vloeroppervlakte van 0,51 m²
B. 102 x D. 50 cm



Werkstand

Bureau met blad in lijn,
vloeroppervlakte 0,81 m²
B. 161,5 x D. 50 cm



Werkstand

Bureau met blad in hoek,
vloeroppervlakte 1,2 m²
B. 107 x D. 112,5 cm

Kleuren- kaart

Melamine
Meubelombouw
dikte, 19 mm

**R3**

Draaibaar blad

**MG****MK**
Zwart
melamine
fluweel-
structuur**PRIJSLIJST P. 29**

Details en levertijden

**ALLE INFORMATIE
ONLINE!**



© Dragonimages

7u

Zolang brengt 70% van de bevolking per dag zittend op een stoel door

Waarom een zit-sta bureau?

Het menselijk lichaam is bestemd om te bewegen, maar door onze hedendaagse levensstijl en het ingeburgerde telewerk zijn velen van ons dagelijks urenlang aan een stoel gekluisterd. Die zittende levensstijl is niet zonder risico's voor onze gezondheid.

De risico's van een zittende levensstijl



Musculoskeletale aandoeningen



Mentale gezondheidsproblemen



Hart- en vaatziekten



Diabetes (Type 2)

Sta geregeld op en verander van houding

Gebruikers van bureaus met hoogteregeling getuigen*

88%

Geeft aan dat zit-sta bureaus gebruiksvriendelijk zijn

47%

Ervaart een verminderde spanning ter hoogte van de rug, nek en schouders

65%

Kan zich beter concentreren en is productiever

Staan werken **verhoogt de productiviteit met 10%***

De juiste houding

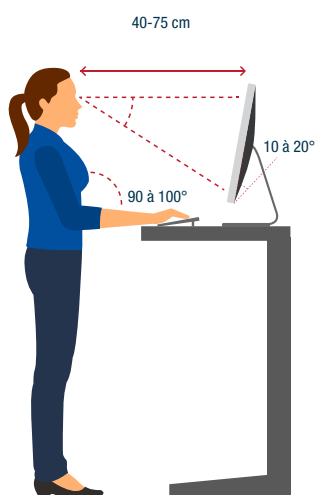

POSITIE VAN HET SCHERM

De bovenkant van het scherm moet zich op ooghoogte bevinden. Het scherm staat licht gekanteld. De ideale afstand tot het scherm is een gestrekte arm.

POSITIONNEMENT DES PIEDS

De voeten moeten stevig op de vloer staan, licht uit elkaar zodat er een driehoek ontstaat tussen de benen en het bekken.

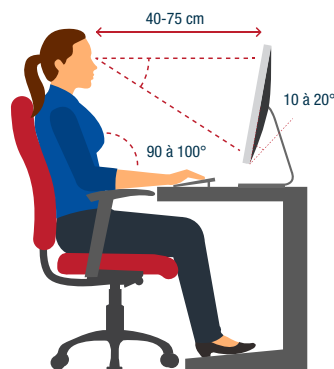

POSITIE VAN DE ARMEN

Als de hand op het bureau rust, moet de elleboog een rechte hoek vormen. De schouders moeten ontspannen zijn en de voorarmen evenwijdig met de vloer. De pols is minimaal gebogen.

HOE WISSEL JE AF VAN HOUDING?

Voor elke 30 minuten werken,

- Blijf 20 minuten zitten
- Werk 8 minuten staand
- Wandel rond en rek je uit gedurende de resterende 2 minuten.

Wissel om de 20 minuten van zittende naar staande houding

* Bron: US National Library of Medicine



Axel 2

NIEUW

HET BUREAU DAT AAN UW GEZONDHEID DENKT

Axel 2 draagt direct bij aan de gezondheid van de werknemers doordat gebruikers kunnen afwisselen tussen zitten en staan, waardoor zittend werk wordt voorkomen. Zowel voor individuele, groeps- of vergaderwerkplekken biedt Axel 2 de juiste ergonomische oplossing..





Axel 2 is verkrijgbaar in elektrische zit/sta of met hendel. Een compleet assortiment bureaus en vergadertafels ontworpen om zich aan elke situatie aan te passen en beweging gedurende de werkdag te stimuleren.



Multifunctioneel en ergonomisch

Meerdere ruimtes

Een gevarieerd aanbod voor open ruimtes met bureaus of vergaderzalen

.....

Personaliseerbaar

Bekablingsoplossingen op maat. Mogelijkheid om scheidingswanden toe te voegen

.....



.....

Optimaliseer

Een telescopische goot voor bladen van 120 tot 180cm

.....

Veiligheid

De elektrische versie heeft een geïntegreerd antiblokkeersysteem

.....

Krachtig motorsysteem

1 motor per zuil

Opties



Verrijdbaar

Discrete wielen met rem
Ø 40mm. Voor alle vloertypes



Privacy-panelen in stof

Geluiddempende
of standaardversie



Kies uw type afregeling



Regeling met hendel

Regelbaar H 71.5 tot 115.5 cm

- Voor een nauwkeurige positionering zonder elektrische aansluiting
- Hoogte regeling in stappen van 1cm
- Gemakkelijk te hanteren
- Hendel verdwijnt onder het blad
- Alleen voor de individuele bureaus en gedeelde frames



Gemotoriseerd verstelsysteem

Regelbaar H 65 tot 130 cm

Intuïtief bedieningspaneel, ideaal voor flexplekken:

- LCD-scherm met hoge resolutie met vervolgkeuze menu
- 4 gebruikers met elk 2 positiegeheugens: zittend of staand
- Alarm met herinnering om recht te staan
- Talrijke andere instellingen mogelijk



Directe toegang tot
1 USB-laadpoort (A+C)



Eenvoudig bedieningspaneel voor vergadertafels

- 4 geheugenposities



Opties



Bekabelingsoplossingen

Bij de bench kan op telescopische goot een extra groot schuifdeksel geïnstalleerd worden voor kabeldozen en kabels. Kabelkokers zie opties



Verticale kabeloplossing

Uittrekbare kabelkoker of magnetische kabelgoten



Axel 2 samenstellen



Individueel bureau

Twee bureaus tegenover elkaar of alleen, dankzij Axel 2 kan je gemakkelijk van houding wisselen..



Bureaus met aanbouw

Optimaliseer je werkoppervlak dankzij het Axel2 bureau met aanbouw.



Overzicht

Individuele bureaus

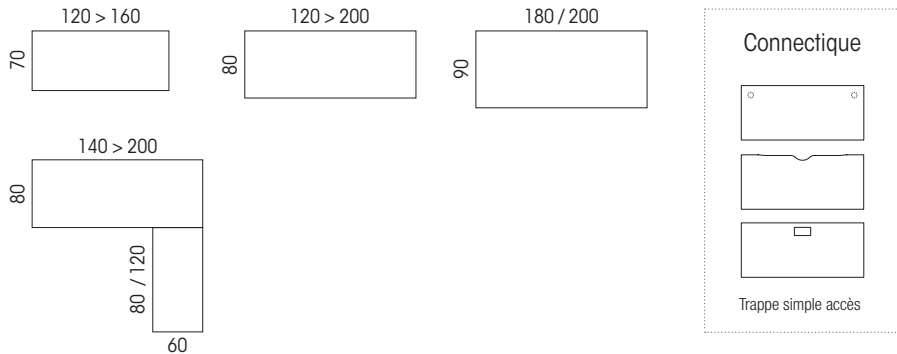

Bureaus met gedeeld onderstel

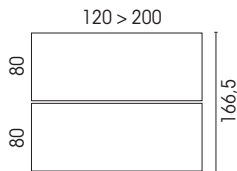

Privacy-panelen

Voor bureaus met gedeeld onderstel

Geluiddempende stof Non Geluiddempende stof



Voor individuele bureaus, zie privacy-panelen P. 116

Vergadertafels

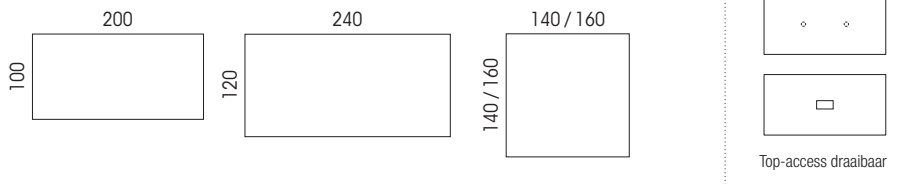

Kleurenkaart

Melamine

Bladdikte 25 mm

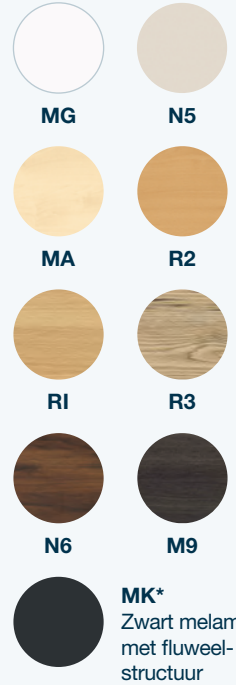

Metaal

Poten



Stof

Panelen

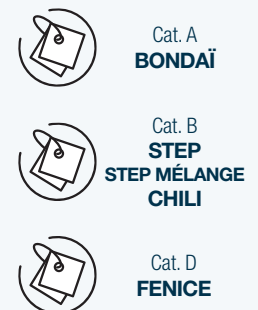

PRIJSLIJST P. 29

Details en levertijden

ALLE INFORMATIE ONLINE!



Bureaus gedeeld onderstel In vergadering

De duo-versie kan worden gebruikt in open ruimtes om de communicatie tussen collega's te stimuleren, ook al zit de ene neer en staat de andere recht.

Keuze uit verschillende tafelformaten om houdingen af te wisselen en uitwisselingen te stimuleren.



Lutz 2

NIEUW

TOEGANKELIJKE ZIT-STA BUREAUS

Een reeks individuele bureaus met een gemotoriseerd systeem tegen een voordelige prijs, om af te wisselen tussen zittend en staand werken en om langdurig zitten tegen te gaan.





Het praktische bedieningspaneel met geheugenfunctie biedt ook directe toegang tot een USB A+C oplaadpoort. Het heeft ook een ingebouwd alarm om gebruikers eraan te herinneren om recht te staan.



Overzicht

Dikte 19 mm

120 > 160



Dikte 25 mm

120 > 180



Connectiek



Dikte 19 mm

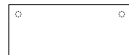

Dikte 25 mm

Bediening



Gemotoriseerd N

- In de hoogte verstelbaar van 71,5 tot 117,5 cm
- Bedieningspaneel met digitaal display
- 3 geheugenposities
- 1 geïntegreerde USB-oplader (A+C)
- Alarm ter herinnering om recht te staan
- Andere regelingen mogelijk



Zuinig en ergonomisch

Keuze van de bladen

Dikte 19 mm of 25 mm

Geoptimaliseerd

Telescopische structuur voor bladen
L. 120 tot 180 cm



Kabelgeleiding

Kabeldoppen,
uitsparing of luik

Veilig

Geïntegreerd
antiblokkeersysteem

Esthetisch

Afgeronde voetsteun met
steldoppen

Kleuren- kaart

Melamine

Bladdikte. 19 mm* of
25 mm



MG



N5



MA



R2



RI



R3



N6



M9



MK

Zwart
melamine met
fluweel-
structuur

* Bladdikte 19 mm alleen
leverbaar in afwerkingen
RI en MG

Metaal

Poten



SO



Z4



SG

Opties



Discrete wielen

ø 40 mm, met rem
(alle vloertypes)



Uittrekbare kabelkoker

(te bevestigen onder het
blad)



Magnetische kabelgoot

(te plaatsen op het
onderstel)

PRIJSLIJST P. 34

Details en levertijden

**ALLE INFORMATIE
ONLINE!**





Robin

ZACHTE EN NATUURLIJKE LIJNEN!

Bureaus met een huiselijke uitstraling. ROBIN valt op met zijn elegante massieffhouten poten. Die zijn licht afgerond en voegen een zachte en warme sfeer toe aan de werkomgeving.

Productie
in Frankrijk



Antibacterieel
oppervlak



Een uitgebreid aanbod, zowel voor het managementbureau en de co-working spaces als voor de vergaderruimte.



Overzicht

Individuele bureaus

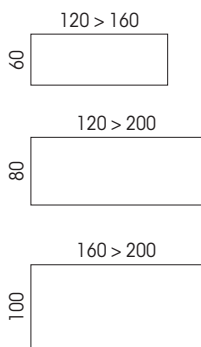

Bureaus met gedeeld onderstel

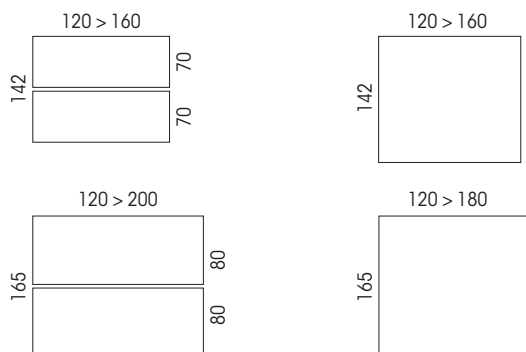

Aanbouwbladen

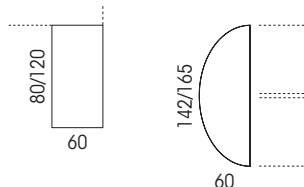

Connectiek

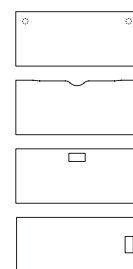

Alleen bladen D.100 cm



Trendy & Naturel



Bureaus met gedeeld onderstel

D.142 of 165 cm
Enkel of dubbel blad



Individuele bureaus

D. 60 tot 100 cm



.....

Eigentijds design

Houten Bridgepoot
Voegt een zachte en warme
toets toe aan de werkomgeving

.....

Kabelgeleiding

kabeldoppen,
uitsparing of luik

.....

Snelle montage

Poten en dwarsdrager
gemonteerd geleverd



Zoom



**Schuine poot van massief
beuken**



Opties



Frontpaneel
In stof, melamine of metaal

Kleuren- kaart

Melamine

Bladdikte. 25 mm



MG



N5



RI



MK*
Zwart
melamine
met fluweel-
structuur

Metaal

Dwarsdrager onderstel



SO



SG

Hout

Poten



MS

PRIJSLIJST P. 35

Details en levertijden

**ALLE INFORMATIE
ONLINE!**





Conect

DE LOGISCHE KEUZE VOOR GEDEELDE BUREAUS!

Bridgepoten of framepoten met strakke lijnen, een blad dat boven het onderstel lijkt te zweven... CONECT voegt lichtheid toe aan de werkomgeving.

Productie
in Frankrijk





De monobloc structuur leent zich optimaal voor gedeelde bureaus. Met het systeem basis en aanbouw kan CONECT eindeloos uitgebreid worden naargelang de beschikbare ruimte en het aantal medewerkers.



2 pootypes



Bridgepoot
VAST H. 73,5 cm
RH 62 tot 86 cm



Frame
VAST H. 73,5 cm



Tijdloos & polyvalent

Individuele bureaus

D.60 tot 80 cm



Bureaus met gedeeld onderstel

D.142 en 165 cm

Met enkel of dubbel blad



Tijdloos design

Portaalpoot of framepoot,
één geheel
Rechthoekige doorsnede
(60 x 30 mm)

Transparante stijl

Het blad lijkt boven het onderstel
te zweven voor een lichte
uitstraling

Kabelgeleiding

Kabeldoppen, uitsparing
of luik



CONNECT samenstellen



Voorbeelden van opstellingen



Werken

Extra werkruimte met een dragend ladeblok onder het hoekblad



Opbergen

Dragend opbergmeubel kies uw opbergsysteem
Het dragend opbergmeubel biedt zowel
extra werkoppervlak als opbergruimte



Overzicht

Individuele bureaus

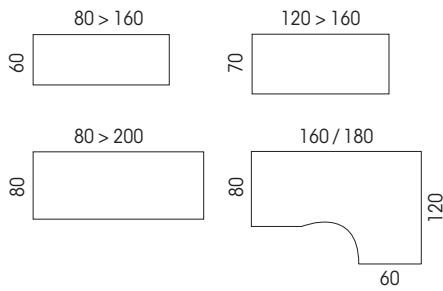

Bureaus met gedeeld onderstel

- bestaat ook met schuifblad

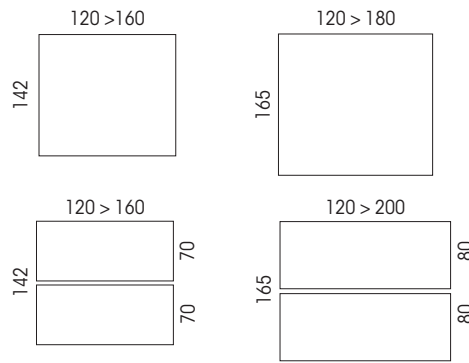

Individuele bureaus met opbergmeubel

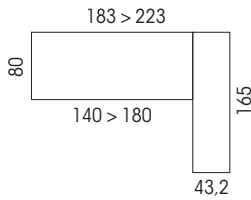

Bureaus met gedeeld onderstel met opbergmeubel

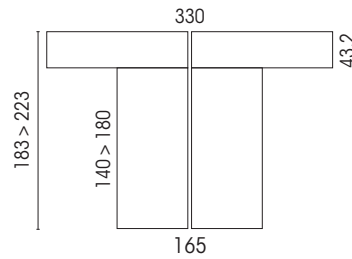

Aanbouw

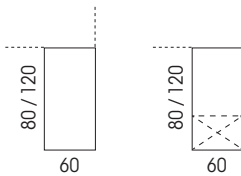

Aanbouwbladen

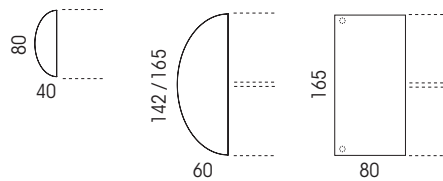

Connectiek

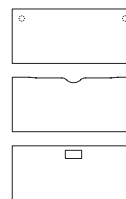

Vergaderen

De versie met enkel blad kan naargelang de gekozen connectiek gebruikt worden als bureau of vergadertafel!

Kleurenkaart

Melamine
Bladdikte. 25 mm

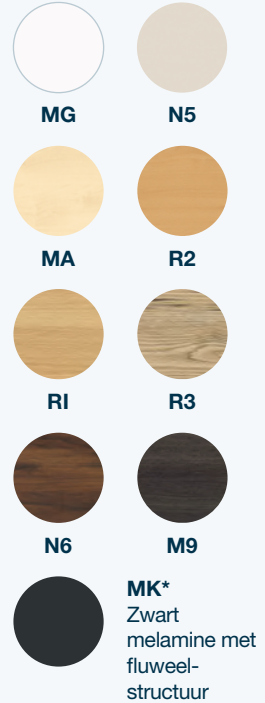

Metaal
Poten

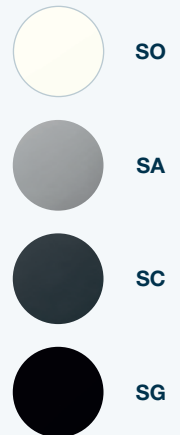

PRIJSLIJST P. 38

Details en levertijden

ALLE INFORMATIE
ONLINE!





Arial

DE DEFINITIE VAN EEN FLEXIBELE WERKOMGEVING!

Met de eenvoudige vormen en het uitgebreide modellenaanbod is ARIAL zowel geschikt voor werk- en vergaderruimtes als voor opleidingslokalen.

Productie
in Frankrijk



Alleen voor vaste bureaus (zonder wielen) en RH
bladikte 25 mm

Antibacterieel
oppervlak



De verrijdbare versie maakt de werkomgeving extra flexibel. De medewerkers passen de opstelling naar wens aan binnen dezelfde ruimte.



Overzicht

Individuele bureaus



d Leverbaar in verrijdbare versie H. 73,5 cm

Bureaus met gedeeld onderstel

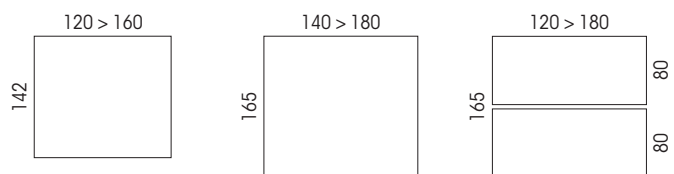

Aanbouw

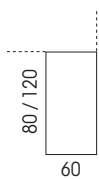

Connectiek

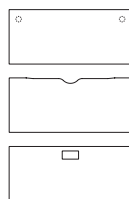

• Bladdikte 19 mm alleen leverbaar voor bureaus D. 80 en D. 165, bladen
 • zonder perforaties voor vrijstaande bureaus

 ARIAL is ook leverbaar in versie Vergaderen, zie p. 168



Eenvoudig & wendbaar

Individuele bureaus

D. 80 en 90 cm



Bureaus met gedeeld onderstel

D. 142 en 165 cm. Leverbaar met enkel of dubbel blad



Minimalistisch design

Eenvoudige vormen die passen in elke ruimte
Vierkante poot (50x50mm)

Polyvalent

Ruim modellenaanbod, zowel voor de werkomgeving en vergaderruimtes als opleidingslokalen (Arial vergaderen p. 168)

Kabelgeleiding

Kabeldoppen, uitsparing of luik



2 ondersteltypes

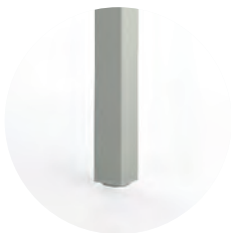

Bridge poten

Voor individuele bureaus en gedeeld onderstel

VAST H. 73,5 cm
RH 62 tot 86 cm (bij montage)



Verrijdbare bridge poten

Voor individueel bureau

VAST H. 73,5 cm
(Zwarte wielen met rem, alle vloeren)

Kleurenkaart

Melamine

Bladdikte 19 mm* of 25 mm



MG



N5



MA



R2



RI



R3



N6

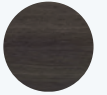

M9



MK Zwart melamine met fluweelstructuur

* Bladdikte 19 mm alleen leverbaar in afwerkingen RI en MG

Metaal

Poten



SO



SA



SC



SG

PRIJSLIJST P. 42

Details en levertijden

ALLE INFORMATIE ONLINE!





Idol

HET BUREAU VOOR HET DIGITALE TIJDPERK!

De pootvorm van IDOL staat voor maximaal gebruikscomfort met vrije beenruimte onder het bureau. Het afneembare deco paneel voegt een extra accent toe en verbergt kabels die door de poot worden geleid.

Productie
in Frankrijk





Tijdloos & polyvalent



Pootversies

Centraal of excentrisch voor vrije
beenruimte onder het blad

Bladversies

Rechte bladen, asymmetrische
of symmetrische hoekbureaus,
talrijke configuraties

Kabelgeleiding naar het blad

Blad vorgeboord voor
kabeldoppen (optie)

[] 2 pootversies



Centraal

Vaste H. 73.5 cm
Met of zonder deco paneel
RH. 62 TOT 86 cm
Inclusief deco paneel



Excentrisch

Vaste H. 73.5cm
Met of zonder deco paneel



Deco paneel

Verbergt kabels
door de poot



Frontpaneel

Structureel voor
excentrische vaste poot of
optioneel voor centrale poot

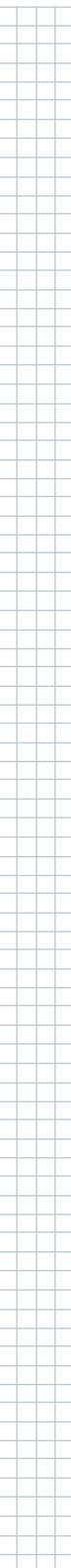



IDOL samenstellen



Maximale werkruimte

.....
Aanbouwblad met dragend ladeblok voor extra opberg-en werkruimte



.....
Excentrische poot met structureel frontpaneel



Overzicht

Individuele bureaus

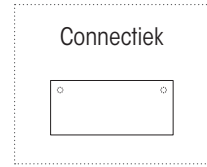
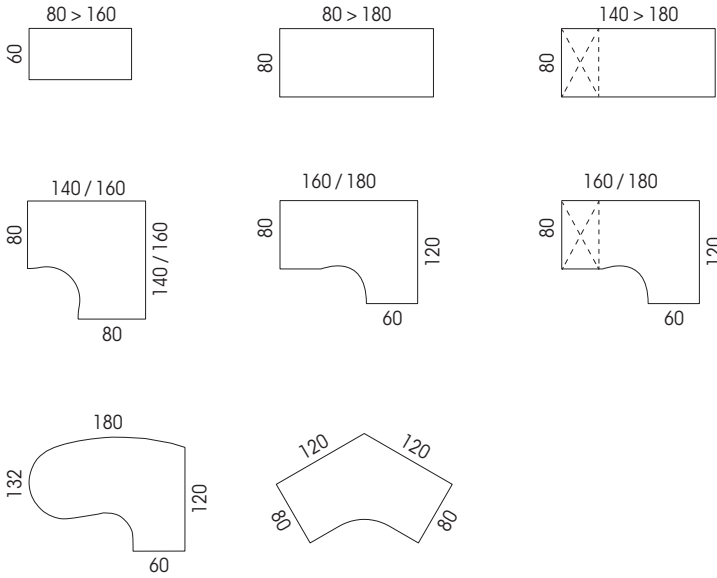

Aanbouw

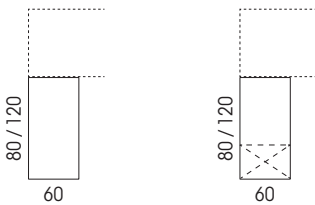

Aanbouwbladen

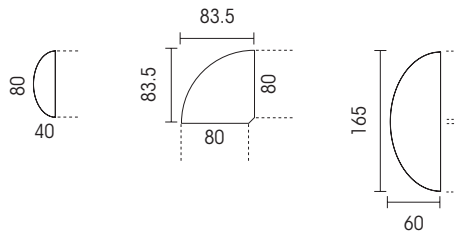

Kleurenkaart

Melamine
Bladdikte 25 mm

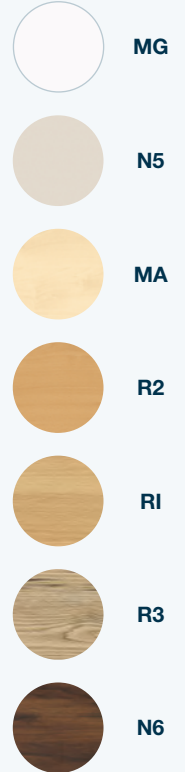

Metaal
Poten, deco panelen

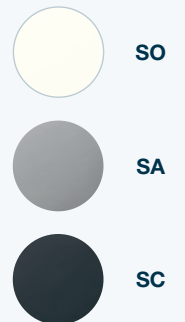

Gevarieerde opstellingen

Opstelling met drie bureaus voor co-working in alle comfort

PRIJSLIJST P. 44
Details en levertijden

**ALLE INFORMATIE
ONLINE!**





Forstyl

Overzicht

Individuele bureaus

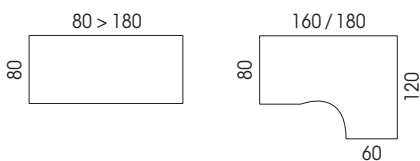

Aanbouwbladen

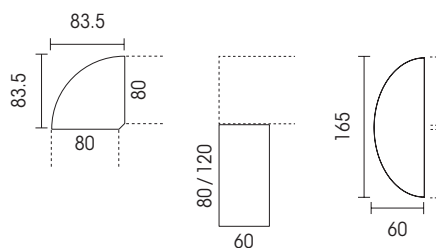

Connectiek



Productie
in Frankrijk





Decoratief & budgetvriendelijk



Kleuren- kaart

Melamine

Bladen, paneelpoten
dikte 25 mmn front-
paneel



MG



R2



R1

Metaal

Vloersteun L-poot



SA

Afwerkingen

Structureel frontpaneel in
de kleur van het blad

Connectiek op het blad

Blad voorgeboord voor
kabeldoppen (optie)

Kabelgeleiding

Frontpaneel met aan de twee
uiteinden een opening voor
kabelgeleiding

[] 2 onderstel versies



Paneelpoot
H.73,5 cm



L-poot
H.73,5 cm

PRIJSLIJST P. 47

Details en levertijden

**ALLE INFORMATIE
ONLINE!**





Solange

CO-WORKING IN ALLE PRIVACY

SOLANGE valt op met zijn ronde lijnen en biedt een elegante oplossing om co-working spaces op te delen zodat iedereen zich maximaal kan concentreren.

Productie
in Frankrijk

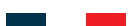



Met het doordachte koppelsysteem kunnen privacy-panelen en scheidingswanden zonder gereedschap gecombineerd worden om de werkomgeving volledig naar wens in te richten.



Doordacht en geluiddempend

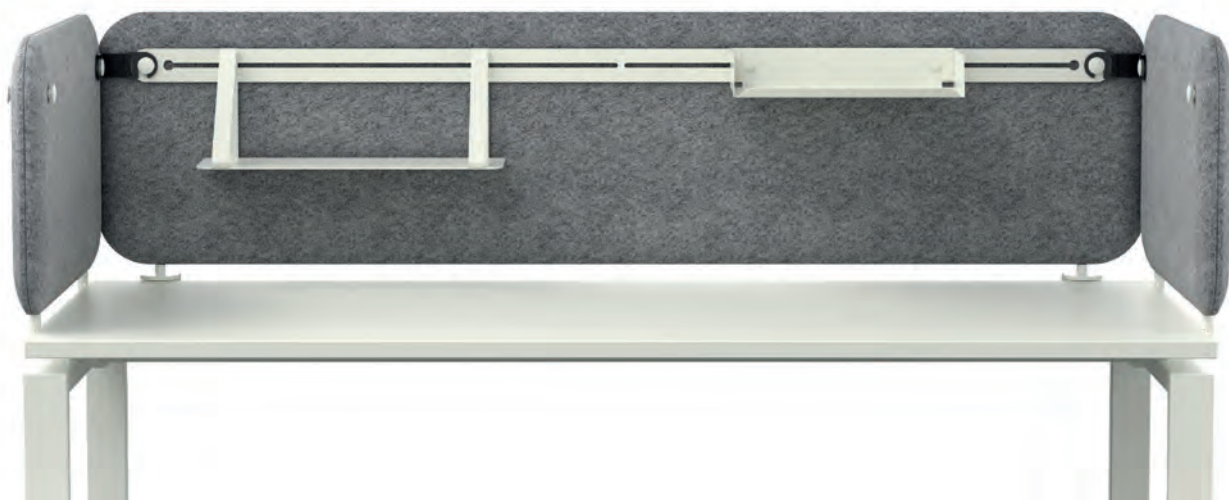

Privacy-panelen voor verschillende toepassingen

Frontaal of lateraal, los geplaatst of bevestigd

Geschikt voor bladdiktes 19 tot 30 mm

Praktisch

Accessoires makkelijk te bevestigen en verplaatsen

Geluiddempend*

Ongeveer 50% van de geluidshinder wordt geabsorbeerd

Gerecycleerd en duurzaam

Kern van gerecycled katoen voor 40 en 50 cm hoge privacy panelen.
Kern van honingraatkarton, vervaardigd uit 100% gerecycleerde vezels, overtrokken met ecologisch polyester-vezelschuim voor 70 cm hoge privacy panelen en geluiddempende scheidingswanden.

Zooms



◀ Knoppen

Esthetisch en functioneel



◀ Los geplaatst

Paneelversie met potenset



Montage & demontage zonder gereedschap



Afgeronde hoeken

Voor een eigentijdse stijl



Doordacht

Koppelset om 2, 3
of 4 wanden zonder
gereedschap met elkaar
te verbinden



Vast of verrijdbaar

Wielen voor alle
vloertypes

Versies

Geluiddempende
of standaardversie

[] Opties



◀ Koppelset

Om scheidingswanden
of privacy-panelen met
elkaar te verbinden



◀ Schrijfbord

Met pennenbakje.
Wordt bevestigd aan
een privacy-wand



Akoestische kast
CLAUDINE, (Exclu Web)
 - Bureau **CONNECT**, p.100

SOLANGE samenstellen



Vrije werkruimte

Accessoires om de werkpost van elke medewerker te personaliseren

Het privacy-paneel in versie H.70 cm is tegelijk een frontpaneel voor het bureau



Overview

Privacy-panels

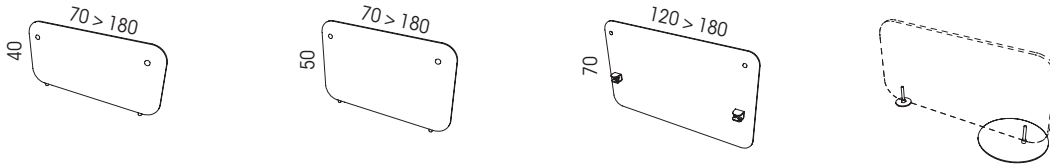

Bevestigingsklemmen - Geschikt voor bladdiktes 19 tot 30 mm

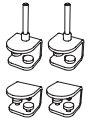

Frontale bevestiging voor individuele bureaus

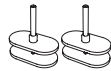

Dubbele bevestiging voor tegenover elkaar geplaatste of bench bureaus



Bevestiging door het blad voor bench bureaus met monoblad

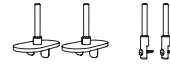

bureaus of aan het uiteinde

Rails en accessoires voor scherm

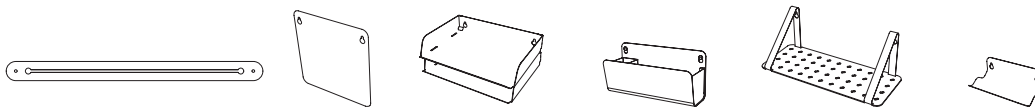

Laterale bevestiging tussen

Scheidingswanden

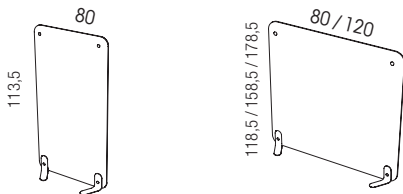

Accessoires

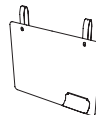

Wit schrijfbord met pennenbakje en metalen haken

Verbindingsset panelen en wanden



Poten voor wanden: vast (opstellingen met een of meerdere wanden) of op wielen



Ruimte-indeling

In li lledig naar wens in te richten

Kleurenkaart

Stof

Panelen dikte 42mm en wanden dikte 47 mm



Cat. A
BONDAI



Cat. B
STEP
STEP MÉLANGE
CHILI



Cat. D
FENICE

Metaal

Klemmen, poten, rail, accessoires



SO



SA



SC



SG

PRIJSLIJST P. 49

Details en levertijden

ALLE INFORMATIE ONLINE!





Kleuren-kaart

Melamine

Privacy-panelen dikte 19 mm, scheidingswanden dikte 25 mm



MG



N5



MA



R2



RI



R3



N6



M9



N9

Stof

Privacy-panelen en scheidingswanden dikte 25 mm



Cat. A
BONDAl



Cat. B
**STEP
STEP MÉLANGE
CHILI**



Cat. D
FENICE

Metaal

Klemmen, poten, rails, accessoires



SO



SA



SC



SG

PRIJSLIJST P. 52

Details en levertijden

ALLE INFORMATIE
ONLINE!



Twins

+ Ideaal voor kleine budgetten

Diverse afmetingen

Privacy-panelen H 40 cm (B 80 tot 200 cm)
Scheidingswand H 160 x B 80 cm

Diverse materialen

Melamine of stof

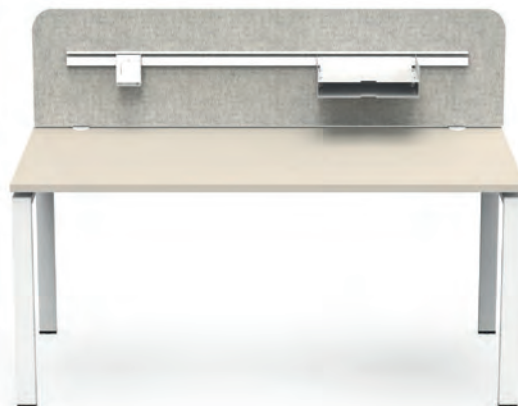

Gerecycleerd

Voor de stoffen versies wordt gebruik gemaakt van restanten of gedeclasseerde panelen

Praktisch

Accessoires worden bevestigd op een rail (postbakje en potloodbekertje)

* Klemmen naargelang de opstellingen (voor bladdiktes 19 tot 30 mm)

* Stabilisatiepoten voor wanden

Productie
in Frankrijk



Antibacterieel
oppervlak





Lucien

+ Robuust & geluiddempend

Robuust

Aluminium frame met geïntegreerde rail H.40 cm (B. 80 tot 180 cm)

Flatscreenhouder

Wordt op de rail bevestigd (zie P.274)

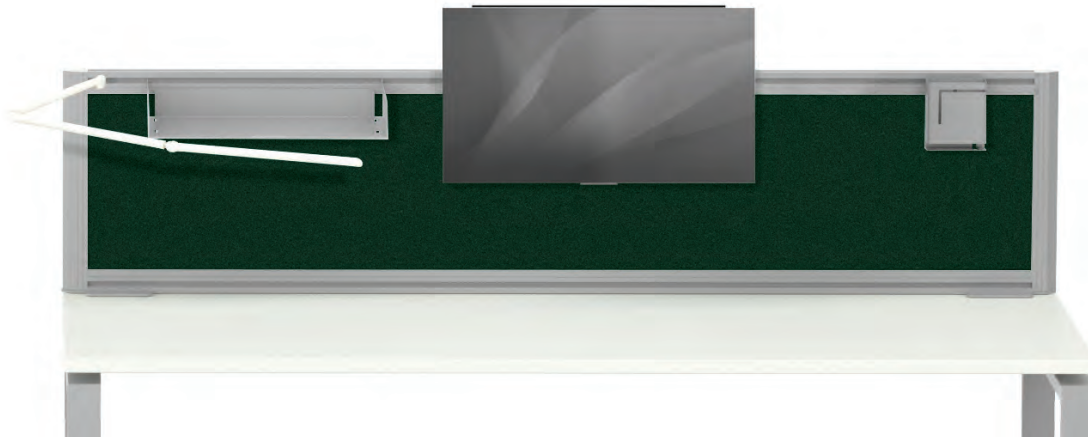

Praktisch

Accessoires worden bevestigd op een rail (postbakje en potloodbekertje)

Geluiddempend

Ongeveer 80% van de geluidshinder wordt geabsorbeerd

*Klemmen naargelang de opstellingen (voor bladdiktes 19 tot 30mm)

*Verbindingsset voor frontale en laterale panelen

Productie
in Frankrijk



Kleurenkaart

Stof

Panelen dikte 42 mm



Cat. A
BONDAÏ



Cat. B
**STEP
STEP MÉLANGE
CHILI**



Cat. D
FENICE

Metaal

Frame, klemmen en accessoires



SO



SA



SC

PRIJSLIJST P. 53

Details en levertijden

**ALLE INFORMATIE
ONLINE!**





Opbergmeubilair



James

PERSOONLIJKE OPBERGRUIMTE

Pagina 126 ›

.....



Gustave

PERSOONLIJKE OPBERGRUIMTE

Pagina 128 ›

.....



PERSOONLIJKE OPBERGRUIMTE

Pagina 130 ›

.....



Melamine ladeblokken eco

PERSOONLIJKE OPBERGRUIMTE

Pagina 133 ›

.....



Opzetelement

PERSOONLIJKE OPBERGRUIMTE

Pagina 133 ›

.....



Metalen ladeblokken

PERSOONLIJKE OPBERGRUIMTE

Pagina 134 ›

.....



Camille

COLLECTIEVE OPBERGRUIMTE

PERSOONLIJKE OPBERGRUIMTE

Pagina 136 ›

.....



Armand

COLLECTIEVE OPBERGRUIMTE

PERSOONLIJKE OPBERGRUIMTE

Pagina 140 ›

.....



Ariv

COLLECTIEVE OPBERGRUIMTE

Pagina 144 ›

.....



Archief-ladekasten

COLLECTIEVE OPBERGRUIMTE

Pagina 149 ›

.....



Navert

COLLECTIEVE OPBERGRUIMTE

Pagina 146 ›

.....



Rekken

COLLECTIEVE OPBERGRUIMTE

Pagina 150 ›

.....



Demonteerbare kasten

COLLECTIEVE OPBERGRUIMTE

Pagina 148 ›

.....



Garderobe-kasten

COLLECTIEVE OPBERGRUIMTE

Pagina 152 ›

.....



James

[] 2 steunpoten



◀ Schuine poot

Massief beuken
(ROBIN)

◀ Rechte poot

Metaal (CONNECT
en ARIAL)

[] Optie



◀ Postbakje

Wordt opgehangen
aan de achterkant
van de kastdeur

Productie
in Frankrijk



Antibacterieel
oppervlak



Decoratief & toegankelijk



**Onmiddellijk
toegankelijk**
Open of draadkubus

Beveiligd
Blok met 2 vergrendelbare
vakken voor persoonlijke
spullen

Post
Deur met gleuf
voor postbakje

Overzicht

Voor bench D. 165 cm*

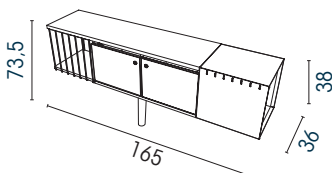
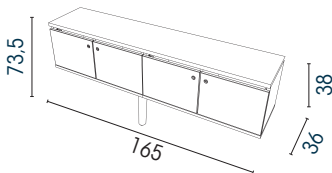

Voor bench P. 142 cm*

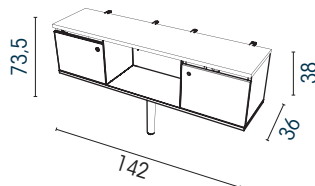

Opties



Metalen verdeler 4 vakken
(alleen voor Bench D. 142 cm)



Postbakje

Kleuren- kaart

Melamine
Ombouw, topblad,
deuren



MG

N5



MA

R2



RI

R3

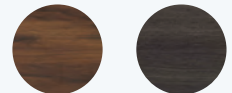

N6

M9



MK/N9*

* MK/N9 : Topblad in
fluweelzwart MK/
Ombouw en deuren
in zwart N9

Metaal
Kubussen, steunpoot
(ARIAL, CONECT),
opties



SO

SA



SC

SG

Metaal / Hout
Steunpoot (ROBIN)



SOMS

SGMS

PRIJSLIJST P. 56
Details en levertijden

**ALLE INFORMATIE
ONLINE!**



* Geschikt voor Bench ARIAL, CONECT en ROBIN



Gustave

Geruisloos

Gedempte sluiting

Handige greep

Grote aluminium
handgreep

Omkeerbaar

Naar keuze rechts
of links openend

Connectiek

(optie)

Productie
in Frankrijk



Antibacterieel
oppervlak



Georganiseerd & doordacht



Kleurenkaart

Melamine
Ombouw, topblad,
ladefront

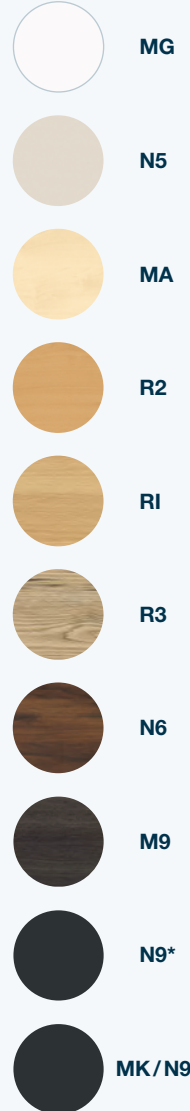

Accessoires



Opbergbakje /
Plantenbakje



Pennen-bakje



Legbord



Magneetbord

Accessoires voor bevestiging op rail – Andere opties: opvulelement, accessoires voor hangmappen

Overzicht

VRIJSTAANDE TOWERS

Lage tower

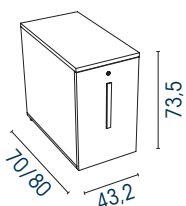

Hoge tower

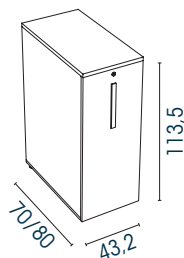

GEDEELDE TOWER

Toegankelijk langs weerszijden,
afsluitbaar vak aan elke zijde

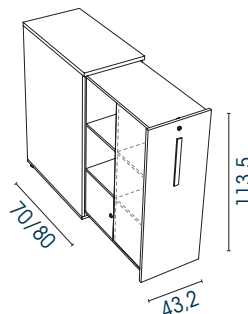

* MK/N9 : Topblad in
fluweelzwart MK /
Ombouw en fronten
in zwart N9 (Alleen
towers H. 73.5 cm)
* N9 : Alleen Tower
H113.05

PRIJSLIJST P. 57
Details en levertijden

**ALLE INFORMATIE
ONLINE!**





Mélina

ALTIJD BINNEN HANDBEREIK!

Het verrijdbare ladeblok MELINA wordt onder het bureau gerold en is leverbaar in plaatsbesparende versie. In de aanbouw- of hoekaanbouwversie creëert het extra werkruimte en veilige opberg ruimte binnen handbereik.

Productie
in Frankrijk





MELINA is uitgevoerd in melamine in het decor van het blad of in contrasterende kleuren. Bovendien is er keuze uit 3 afwerkingen voor de handgrepen.



Kleuren-kaart

Melamine

Ombouw, topblad, ladefront



MG



N5



MA



R2



RI



R3



N6



M9



N9*



MK/N9*

* MK/N9 : Topblad in fluweelzwart MK / Ombouw en fronten in zwart N9 (Alleen ladeblokken H.73,5 cm)

* N9 Alleen verrijdbare ladeblokken

Metaal

Handgreep



SO



SB



SG

PRIJSLIJST P. 58

Details en levertijden

ALLE INFORMATIE ONLINE!



Praktisch & georganiseerd

Compact Plaatsbesparend

B. 32 cm



Verrijdbaar B. 42 cm

4 wielen
(waarvan
2 met rem)



Bureauhoogte

Hoekaanbouw
D. 60 of aanbouw
D. 80 cm



Toegankelijk
Hangmappenlade
volledig uittrekbaar

Georganiseerd
Geïntegreerd
pennenbakje

Geruisloos
Gedempte sluiting

Veiligheid
Slechts 1 lade kan tegelijk
geopend worden, 5de
antikantelwiel

Zoom

Optie



Handgreep

Metaal
3 kleuren
naar keuze



Zitkussen

Bevestigd
met velcro
Dikte 30 mm



LADEBLOKKEN MELAMINE ECO



B. 43,6 x H. 59,1 x D. 56 cm
2 laden waarvan
1 hangmappenlade
3 laden

Verrijdbare ladeblokken (topblad dikte
19 mm)
Ladeblok op bureauhoogte (Topblad
dikte 25 mm)

Slechts 1 lade kan tegelijk worden
geopend

Hangmappenlade met antikantelwiel

Geïntegreerd pennenbakje

Naargelang model, wielen ø 40 mm
of steldoppen



B. 43,2 x H. 73,5
x D. 60 / 80 cm
3 laden waarvan
1 hangmappenlade

Kleuren- kaart

Melamine

Ombouw, topblad,
ladefronten



MG



MA



RI

Metaal

Handgreep



SB



SG

PRIJSLIJST P. 59

Details en levertijden

ALLE INFORMATIE ONLINE!



OPZETMODULE



Opzetmodule met achterwand voor
ladeblokken en towers

Opbergruimte binnen handbereik



D. 80 x B. 43,2 x H. 40 cm

Melamine

Ombouw



MG



N5



MA



R2



RI



R3



N6

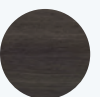

M9

Productie
in Frankrijk



Antibacterieel
oppervlak





Ladeblokken metaal

TOEGANKELIJK, EFFICIËNT EN VEILIG OPBERGEN

Verrijdbare versie of op bureauhoogte. Een metalen ladeblok creëert extra werkruimte en biedt toegankelijke, efficiënte en veilige opbergruimte. Voegt met de strakke lijnen een eigentijds accent toe aan de werkomgeving. Deze metalen ladeblokken onderscheiden zich met een robuuste structuur en een verfijnde afwerking: onzichtbare wielen, in het front geïntegreerde handgreep, topblad.





Praktisch & robuust

Compact
Plaatsbesparend
B. 32 cm



Verrijdbaar
Met onzichtbare
wielen



Bureauhoogte
Hoekaanbouw
D. 60 of aanbouw
D. 80 cm



Toegankelijk
Fronten met
laterale handgreep.
Hangmappenlade
volledig uittrekbaar

Georganiseerd
Geïntegreerd
pennenbakje
Optionele accessoires

Geruisloos
Gedempte sluiting

Veiligheid
Slechts 1 lade kan tegelijk
geopend worden, 5de
antikantelwielkje

Kleuren- kaart

Metaal

Ombouw, topblad,
ladefronts



SO



SB



SC



SG

Melamine

Topbladen



MG



N5



MA



R2



RI



R3



N6



M9



N9*



MK*

* MK Fluweelzwart:
Alleen topblad van
de ladenblokken
H 73.5 cm
N9 : Alleen topblad
van de verrijdbare
ladeblokken

PRIJSLIJST P. 60

Details en levertijden

**ALLE INFORMATIE
ONLINE!**



Opties



Prullenmand 9L
Magneetbevestiging

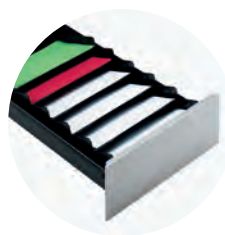

Set van 3 verdelers
Verticaal of schuin



Zitkussen
Dikte 25 mm (bevestigd op
het metalen topblad met
magnetische stroken)



Camille

PERSOONLIJKE OPBERGRUIMTE IN HET FLEXPLEK KANTOOR

CAMILLE maakt het leven van bezoekers en medewerkers er eenvoudiger op door hen in de flexibele kantoorruimte een individuele en beveiligde opbergruimte ter beschikking te stellen.

Productie
in Frankrijk





Leverbaar met enkele of dubbele deur, met of zonder postgleuf. De CAMILLE lockers bieden plaats aan motor- of fietshelmen, handbagagekoffers of andere persoonlijke voorwerpen. Naar keuze met sleutel of cijferslot, met melamine of metalen deuren.



Veilig & personaliseerbaar



Keuze van de materialen

Metalen of melamine deuren

Keuze van de deuren

- Enkel, geschikt voor helmen
- Dubbel, geschikt voor handbagage

Geruisloos

Gedempte sluiting

Verluchting

Geperforeerde rug

[] 2 slottypes



Met sleutel

Voor melamine deuren



Codeslot

Voor metalen of melamine deuren (persoonlijk of gedeeld gebruik)



Overzicht

Ombouw (gemonteerd geleverd)

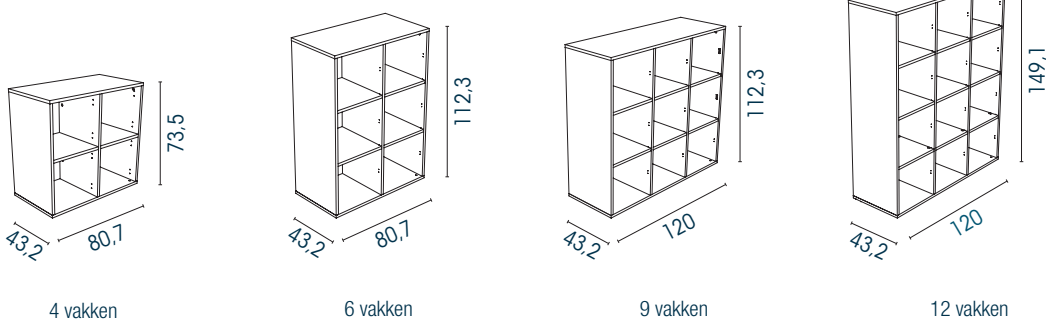

4 vakken

6 vakken

9 vakken

12 vakken

Deuren (met of zonder postgleuf)

Metaal (codeslot)

Melamine (met sleutel of codeslot)

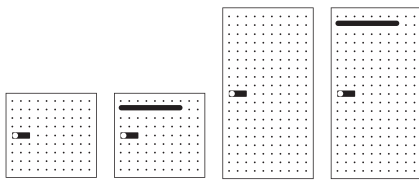

Enkele deuren

Dubbele deuren

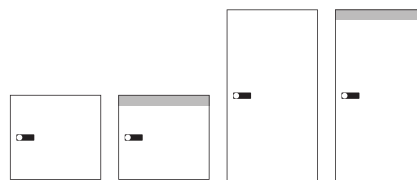

Enkele deuren

Dubbele deuren

Enkele deur voor 1 vak. Bruikbare afm.: B. 37,4 x H. 34,9 x D. 39 cm
 Dubbele deur voor 2 vakken. Bruikbare afm.: B. 37,4 x H. 71,5 x D. 39 cm

Kleurenkaart

Melamine
Ombouw, deuren



MG

N5



MA

R2



RI

R3

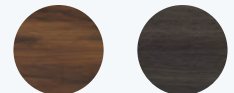

N6

M9



N9

Metaal

Fronten, sokkel,
postbakje



SO



SA



SC



SG

Opties



**4 vierkante
poten alu ABS**
H. 5 cm



Metalen sokkel
H. 20 cm



Postbakje met etikethouder
Wordt aan de binnenkant van
de melamine deur opgehangen

PRIJSLIJST P. 62
Details en levertijden

**ALLE INFORMATIE
ONLINE!**





Armand

OPBERGMEUBILAIR IN AL ZIJN VORMEN

Met de houtafwerkingen en de talrijke modellen is ARMAND de ideale keuze om de werkomgeving te structureren en in te richten met een huiselijk accent

Productie
in Frankrijk



Antibacterieel
oppervlak



De collectie omvat kasten, boekenkasten en garderobekasten, met draai- of schuifdeuren. Opbergmeubilair ARMAND biedt altijd een aangepaste oplossing. Bovendien zijn de handgrepen leverbaar in 3 kleuren.



Functioneel & gevarieerd



Keuzevrijheid voor de deuren

- Schuif- of draaideuren
- In glas of melamine
- Kast met of zonder deuren

Geruisloos

Gedempte sluiting

Veilig

Melamine deur met slot

Steldoppen

Regelbaar langs de binnenkant

Zooms



Rail

Voor schuifdeuren



Geluisloze scharnieren

Zelfremmend

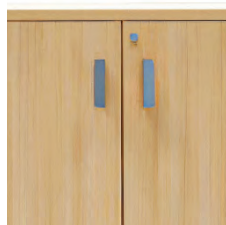

Metalen handgrepen

Voor draaideuren, 3 kleuren naar keuze



Metalen handgrepen

Laterale handgrepen voor schuifdeuren, 3 kleuren naar keuze



Overzicht

Draaideurkasten

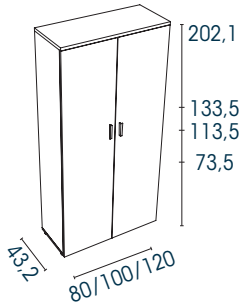

2 melamine deuren

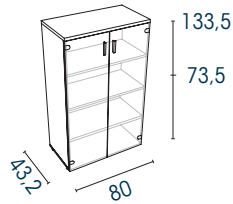

2 glazen deuren



4 melamine of glazen deuren
2 melamine deuren / 2 glazen deuren

Schuifdeurkasten

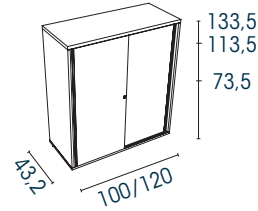

2 melamine deuren

Boekenkasten

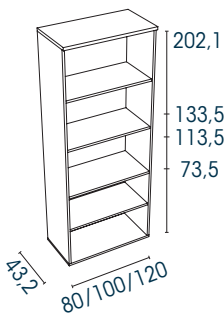

Open

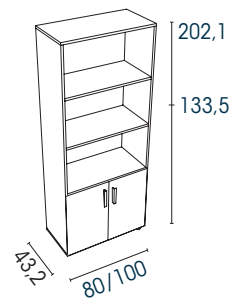

2 melamine deuren

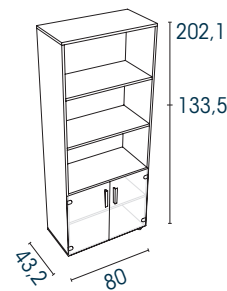

2 glazen deuren

Garderobekast



2 melamine deuren
(2/3 garderobekast 1/3 legborden)

Scheidingsmeubel

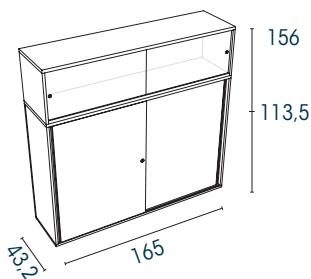

2 melamine schuifdeuren
Opzetelement met
2 Altuglas® deuren

Laagmeubel

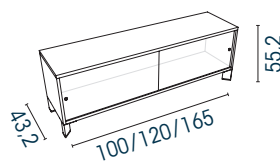

2 Altuglas® schuifdeuren

Archiefbladekast

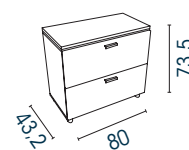

2 hangmappenlades

Optie: topblad, melamine of metalen legborden

Kleurenkaart

Melamine

Ombouw, topblad, deuren



MG

N5



MA

R2



RI

R3

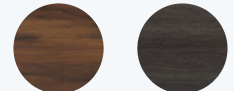

N6

M9



N9

MK/N9*

* MK Fluweelzwart: alleen topblad van de kasten en boekenkasten H73,5 cm. Ombouw en fronten in zwart N9

Metaal

Handgrepen



SO

SB



SG

Glas

Fronten



GS

Altuglas®

Fronten



OA

PRIJSLIJST P. 63

Details en levertijden

ALLE INFORMATIE
ONLINE!





Ariv

+ Esthetisch & verzorgd



◀ **Magneetsluiting**



◀ **Brandwerend**
PVC M1 lamellen

.....

Harmonische afwerkingen

Eindlamel in de kleur van de ombouw

.....

Dossiers onmiddellijk zichtbaar en toegankelijk

De roldeuren openen volledig

.....

Tot 5 archiefniveaus

Rail bovenaan geschikt voor hangmappen (behalve H. 72,1 en opzetelement)

[] **Zooms**



.....

Steldoppen van binnenuit regelbaar



.....

Comfortabel
Verzonken rechthoekige handgrepen





Accessoires



Archiveren

- Horizontaal, verticaal met ordners of hangmappen (Metalen legbord met railsysteem)
- Optimaal verticaal archiveren dankzij verticale verdelers H. 19 cm
- Archiefmodule met 16 vakken formaat A4 B. 104 x D. 33 x H. 32 cm (op een legbord B. 120 te plaatsen)
- Hangmappen makkelijk toegankelijkheid dankzij het optionele telescopisch hangframe (slechts één frame kan tegelijk geopend worden)
- Mogelijkheid om hangmappen frontaal te raadplegen met de dwarsprofielen en drukbeugels (niet geschikt voor kast B. 80 x H. 72,1 cm)

Raadplegen

Volledig uittrekbaar telescopisch werkplateau

Snelle installatie

Markeringen voor de plaats van de legborden en de telescopische hangframes (in stappen van 20 mm)

Kleurenkaart

Metaal Ombouw



SO

SD



SB

SC



SG

PVC Lamellen



SO

SG



SC

SD



SB

MA



RI

Naar keuze kast in één of twee kleuren, zie prijslijst

Melamine topblad, dikte 25 mm, in de kleur van de bureaus

Overzicht

Hoge kasten

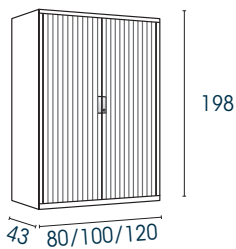

Halfhoge kasten

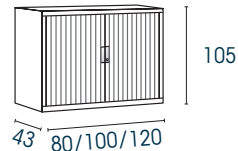
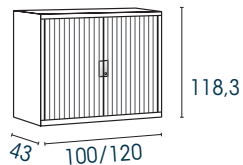
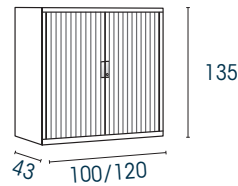
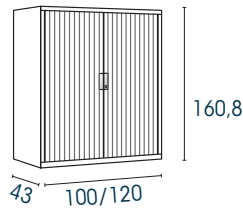

Kasten op bureauhoogte

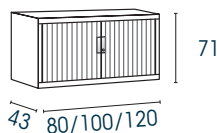
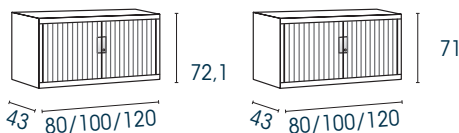

Opzetelement

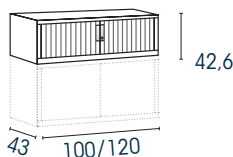

PRIJSLIJST P. 66

Details en levertijden

ALLE INFORMATIE ONLINE!





Navert

+ Betrouwbaar & stabiel



Brandwerend
PVC M1 lamellen



Harmonische afwerkingen

Eindlamel in de kleur van de ombouw

Vlakke bodem

Om dossierdozen onderin de kast makkelijk uit te trekken

Tot 5 archiefniveaus

Ingebouwd legbord bovenaan geschikt voor hangmappen

[] Zooms



Steldoppen van binnenuit regelbaar



Comfortabel

Verzonken afgeronde handgrepen



Accessoires



Archiveren

- Horizontaal, verticaal met ordners of hangmappen (Metalen legbord met railsysteem)
- Optimaal verticaal archiveren dankzij verticale verdelers H. 19 cm
- Hangmappen makkelijk toegankelijkheid dankzij het optionele telescopisch hangframe (slechts één frame kan tegelijk geopend worden)

Raadplegen

Volledig uittrekbaar telescopisch werkplateau

Snelle installatie

Markeringen voor de plaats van de legborden en de telescopische hangframes (in stappen van 25 mm)



Overzicht

Hoge kasten

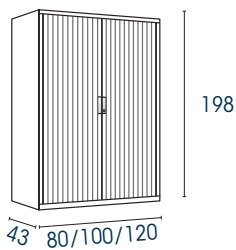

Halfhoge kasten

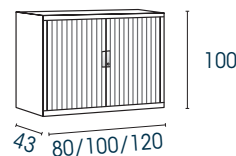
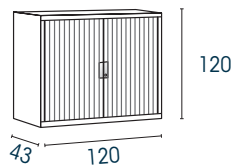
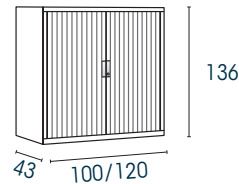
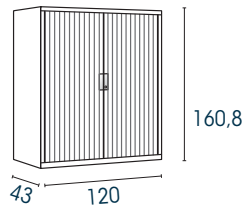

Kasten op bureauhoogte

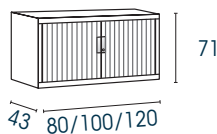
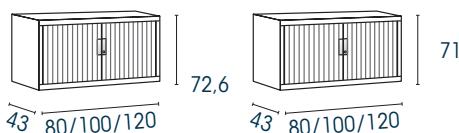

Opzetelement

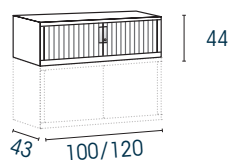

Kleurenkaart

Metaal Ombouw



SO



SD



SB



SC



SG

PVC Lamellen



SO



SG



SC



SD



SB



MA



R2



RI

Melamine topblad, dikte 25 mm, in de kleur van de bureaus

Naar keuze kast in één of twee kleuren, zie prijslijst

PRIJSLIJST P. 67

Details en levertijden

**ALLE INFORMATIE
ONLINE!**





Demonteerbare kast

+ Voor moeilijk toegankelijke plaatsen



Brandwerend
PVC M1 lamellen

.....

Magnetische sluiting & vergendelbaar

Eindlamel met 2-punts slot

.....

Geschikt voor ordeners en hangmappen

.....

Tot 5 orderniveaus

De rail bovenaan is geschikt
voor hangmappen

Kleurenkaart

Metaal & PVC



SDSD
Lichtgrijs



SCSC
Antraciet

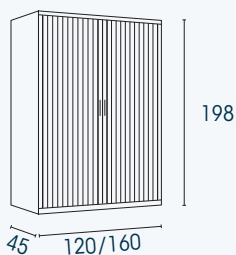

PRIJSLIJST P. 62

Details en levertijden

ALLE INFORMATIE ONLINE!



Hangmappenkasten



Centrale vergrendeling
(loper op aanvraag)

Antikantelveiligheid
waarbij slechts 1 lade tegelijk kan worden geopend

Ergonomische handgrepen
en geïntegreerde etikethouders

Telescopische geleiders met kogellagers en eindbevestiging

Laden voor hangmappen
formaat A4

Optie : bodem voor het toevoegen van ladeverdelers

3 hoogtes : 71,1 / 101.6 / 132.4 cm
(B. 41.3 x D. 62.2)

Kleurenkaart

Metaal

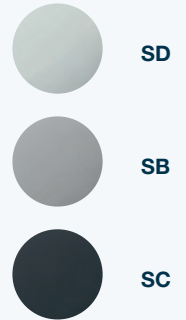

PRIJSLIJST P. 62

Details en levertijden

ALLE INFORMATIE ONLINE!



Archiefladekasten Metaal



PVC handgrepen met geïntegreerde etikethouder
(etiketten niet meegeleverd)

Slot om de 2 laden

Kogellagergeleiders
80 % uittrekbaar

Laden voor hangmappen formaat A4

2 hoogtes : 67.2 / 128.2 cm
(B. 41.3 x D. 40)

Kleurenkaart

Métal

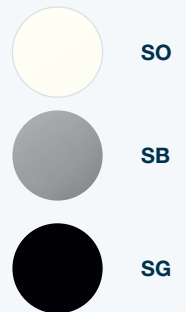

PRIJSLIJST P. 62

Details en levertijden

ALLE INFORMATIE ONLINE!





Buisrek

+ Eenvoudig & stabiel



Snelle montage zonder gereedschap

De liggers worden stevig in de staanders gehaakt

Geprofileerde metalen T-staanders

Staal dikte 7/10e

Legbord bestaande uit 3 of 4 liggers

Gegalvaniseerd staal
Max. 200 kg per ligger

Isorel legbord

Optioneel

Kleurenkaart

Metaal

Gelakte staanders



SC

Metaal

Gegalvaniseerde staanders



ZJ

Basiselement



100/125

250
225
200

D: 35/50/70

Aanbouwelement



100/125

250
225
200

Productie
in Frankrijk



PRIJSLIJST P. 69
Détails en levertijden

**ALLE INFORMATIE
ONLINE!**





Polyvalente rekken

+ Overzichtelijk & toegankelijk opbergen



Stabiel

Schoren voor extra stabiliteit

Staanders 35 x 35 mm

Volle metalen legborden

Max. 120 kg

Per legbord

Legborden ook geschikt voor hangmappen

Metalen legbord met railsysteem

Kleurenkaart

Metaal



SC / SD
Gelakt



ZJ / ZJ
Gegalvaniseerd

Basiselement

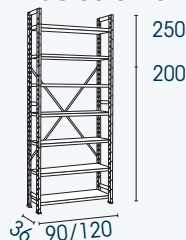

Aanbouwelement

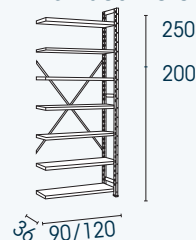

Productie
in Frankrijk



PRIJSLIJST P. 70
Détails en levertijden

ALLE INFORMATIE
ONLINE!





Kleuren-kaart

Metaal

Ombouw en deuren



SDSA
Grijs/grijs



SDSL
Grijs/blauw

PRIJSLIJST P. 71

Details en levertijden

ALLE INFORMATIE
ONLINE!



Industriële garderobekasten



Kantooruitvoering



Industriële uitvoering

Demonteerbare
garderobekasten

Garderobekasten met legbord
en **kledingstang**

Diepgetrokken etikethouder
(etiket niet meegeleverd)

Verluchting
Bovenaan, onderaan en achteraan

Deurknop voor hangslot
(hangslot niet meegeleverd)

Scheidingswand
Tussen persoonlijke kledij en werkkledij
(alleen industriële uitvoering)

Garderobekasten met vakken

Metaal

Ombouw en deuren



SDSL
Grijs/blauw



SDQR
Grijs/rood

PRIJSLIJST P. 71

Details en levertijden

ALLE INFORMATIE
ONLINE!



Demonteerbare garderobekasten

Kledingstang

Verluchting
Bovenaan en achteraan

Inbraakveilige legborden
Tussen 2 vakken boven elkaar

Deurknop voor hangslot
(hangslot niet meegeleverd)





[] Opties



Schuine bovenkant

H. 13 x D. 50 cm
Bestaat in B. 120/160/200 cm
Voor garderobekasten uit één geheel
en demonteerbare garderobekasten



Pootsokkel

H. 15 x D. 50 cm
Voor demonteerbare garderobekasten



Banksokkel

H. 25 x D. 80 cm
Voor garderobekasten uit één geheel
en demonteerbare garderobekasten



Set van 4 poten

H. 15 cm
Voor garderobekasten
uit één geheel

[] Vrijstaande banken



.....

Metalen onderstel
Lichtgrijze vierkante buispoten

.....

Steldoppen

.....

Zit bestaande uit **3 beuken latten**, naturel gevernist





Gemeenschappelijke ruimtes & meeting





Gemeenschappelijke ruimtes & meeting



Karl

VERGADERUIMTE
MEETING

Pagina 158 ›



Modulo

VERGADERUIMTE
MEETING

Pagina 164 ›



Arial

BRAINSTORMING
RESTAURANT
MEETING

Pagina 168 ›



Robin

BRAINSTORMING
MEETING

Pagina 174 ›



E-meeting

MEETING

Pagina 176 ›



Ping

MEETING

Pagina 178 ›



Martin

BRAINSTORMING
MEETING

Pagina 180 ›



Chatbox

MEETING

Pagina 184 ›



Klaptafels

OPLEIDING

Pagina 188 ›





Emi

- OPLEIDING
- RESTAURANT
- MEETING

Pagina 192 ›



Polyvalente tafels

- OPLEIDING
- RESTAURANT
- MEETING

Pagina 190 ›



Tafels met vrije beenruimte

- RESTAURANT
- MEETING

Pagina 191 ›



Vouwtafels

- OPLEIDING
- RESTAURANT
- MEETING

Pagina 193 ›



Eloïse

- RESTAURANT
- MEETING

Pagina 194 ›



Evasion

- RESTAURANT
- MEETING

Pagina 198 ›



Clara

- RESTAURANT

Pagina 201 ›



Lucie

- RESTAURANT

Pagina 202 ›



Iris

- RESTAURANT

Pagina 203 ›





Karl

HOOGWAARDIG MEUBILAIR MET ELEGANTIE EN KARAKTER

KARL onderscheidt zich met een elegant design en hoogwaardige materialen. De strakke lijnen voegen een 'premium' stijl toe aan de vergaderruimte.

Productie
in Frankrijk





Leverbaar in versie Linoleum, melamine of fluweelzwart melamine. De slijtvastheid en zachte textuur van de bladen zijn een belangrijke troef van KARL. Voor grote of kleine vergaderruimtes: met deze tafels kunnen conferentiezalen tot 20 personen ingericht worden.



[o] Zooms



Poot met kabelgeleiding

De kabels zijn toegankelijk dmv. vast te schroeven plaatje. Enkel voor tafel met softclosing luik

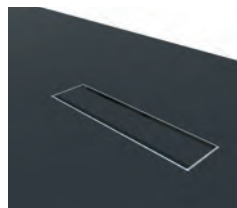

Softclosing luik tweezijdige toegang

In de kleur van het blad



Elegant & hoogwaardig

Elegante vergaderruimtes

Zachte vormen en hoogwaardige materialen (poten van massief eiken)

Zachte en unieke texturen

Naar keuze:

- Fluweelzacht en slijtvast melamine MK
- Zachte en matte textuur in Linoleum (meer kleuren, zie p. 285)

Tafels voor grote of kleine ruimtes

Vierkant of rechthoekig.
Van 6 tot 20 personen

Discrete kabelgeleiding

De kabels worden weggewerkt in de poten
Technische luiken in de kleur van het blad





KARL SAMENSTELLEN

Voorbeelden van opstellingen



De stijl zit hem ook in de stoel

Met de BIP stoelen voor een omhullend en warm effect



Met de Scott stoelen voor een zeer eigentijdse uitstraling



Overzicht*

Rechthoekige tafels

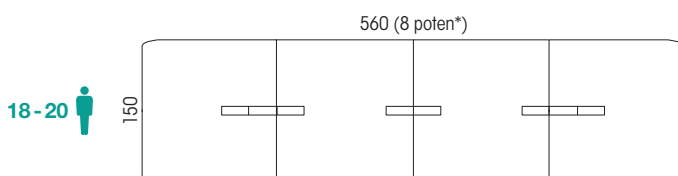
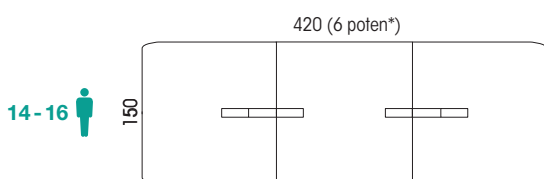
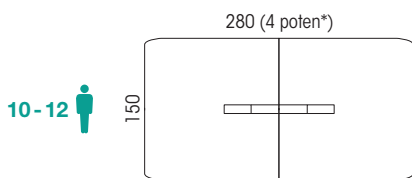

Vierkante tafels

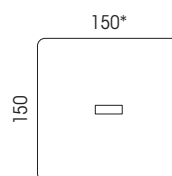
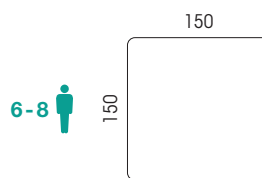

KARL in harmonie met zijn directiebureau p.60

* Voor de bladen met luik :
Vergadertafel L150/280/420 cm incl. 1 poot met kabelgeleiding
Vergadertafel L560 cm 2 poten met kabelgeleiding



Korte briefing /vergaderen

Een vierkante tafel als aanvulling in een bureau of voor een kleine vergaderruimte

Kleurenkaart

Melamine

Bladdikte 25mm



Linoleum

Bladdikte 20,6 mm



Massief eiken

Onderstel



Metaal

Structuur tafels



PRIJSLIJST P. 74

Details en levertijden

ALLE INFORMATIE ONLINE!





Modulo

MODULAIR EN GECONNECTEERD VERGADEREN

Bijzonder geschikt voor de inrichting van conferentiezalen of grote vergaderruimtes. MODULO kan vrijwel eindeloos worden gecombineerd met open of gesloten opstellingen. De afmeting van de tafel kan naar wens worden aangepast met de uitbreidingsset.

Productie
in Frankrijk



Antibacterieel
oppervlak





Deze lijn omvat ook elegante oplossingen voor kabelgeleiding, waardoor altijd een ordelijke indruk gegarandeerd is.





MODULO samenstellen

Overzicht

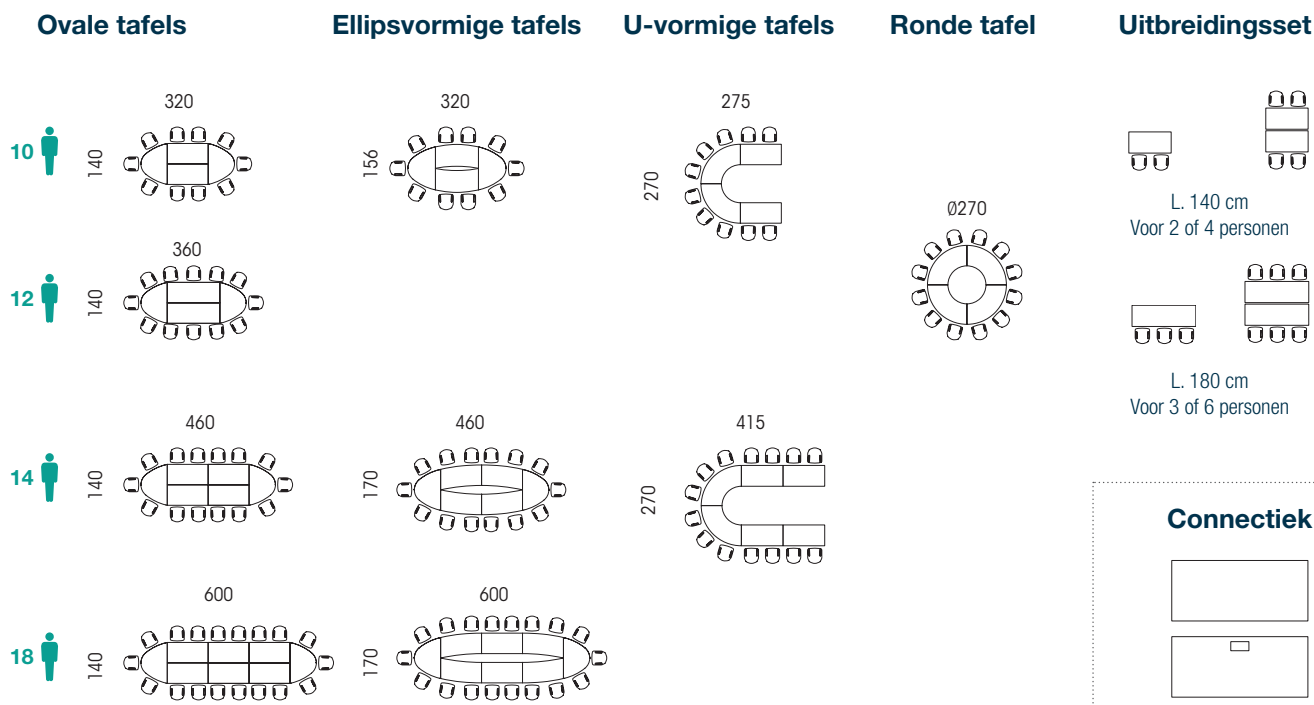

* Een specifieke opstelling in gedachte?
Raadpleeg uw commercieel afgevaardigde

3 poottypes



Paneelpoot
(Melamine)



Ronde poot
(Metaal)



Vierkante poot
(Metaal)



Samengesteld of samenstelbaar, oneindig veel mogelijkheden



Kleuren- kaart

Melamine
Bladdikte 38 mm



RI



N6

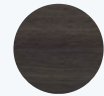

M9

Bladdikte 30 mm



MG



RI

Metaal
Onderstel



SO



SA

Keuze van de bladen

Melamine dikte 30 of 38 mm, 4 verschillende vormen (rechthoek, gerond, ellips of hoek)

Gevarieerde opstellingen

- Ovaal, ellipsvormig, rond of in U
- Van 10 tot 18 personen of meer door uw opstelling te personaliseren

Kabelgeleiding

Blad zonder doorgangen voor losse connectiek of blad met uitsparing voor technisch luik met kabelgoot

PRIJSLIJST P. 75

Details en levertijden

**ALLE INFORMATIE
ONLINE!**





Arial

DOORDACHTTE FLEXIBILITEIT

Voor opleidings- of vergaderruimtes, vast of verrijdbaar, in hoge of standaardversie, ARIAL is synoniem van grenzeloze flexibiliteit.

Productie
in Frankrijk





De verrijdbare versie voegt flexibiliteit toe aan de werkomgeving. Medewerkers passen de inrichting naar wens aan binnen de beschikbare ruimte.



2 poottypes



◀ **Bridge poot**
H. 73,5 of 104,5 cm



◀ **Verrijdbare bridge poot**
H. 73,5 of 104,5 cm



Eenvoudig & flexibel



Standaardhoogte

H. 73,5 cm



Hoge tafels

H. 104,5 cm



Verschillende vormen

Vierkant of rechthoekig.
Van 2 tot 16 personen

Veelzijdig

Ondiepe tafels: ideaal voor opleidings- of
receptieruimtes

Ergonomisch & stabiel

Tafel met voetensteun voor optimaal comfort.
Stabilisatiekabels.

Oplossingen voor kabelgeleiding

Kabeldoppen met rechtstreekse aansluiting
of dubbelzijdig toegankelijk technisch luik



ARIAL samenstellen



Een dag op kantoor met Arial in verrijdbare versie!



Zich concentreren

Ongestoord werken

Het team installeert zich om individueel te werken. De scheidingswanden vormen een visuele opdeling en iedereen kan zich concentreren.



Brainstormen

In projectmodus

Het team past de ruimte aan om te vergaderen, te brainstormen, te overleggen, te beslissen. Met de verrijdbare multimediawand Martin kan geconnecteerd worden met telewerkers.



Overzicht

Rechthoekige tafels

H. 73,5 en 104,5 cm

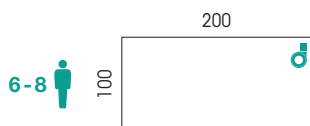
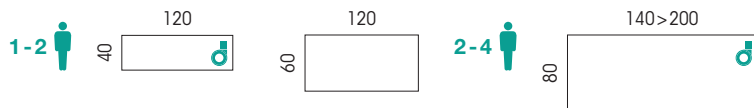

Leverbaar in verrijdbare versie

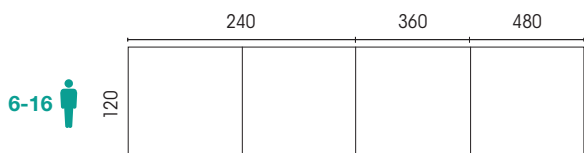

ARIAL bestaat ook in bureauversie, zie p. 106

Vierkante tafels

H. 73,5 en 104,5 cm

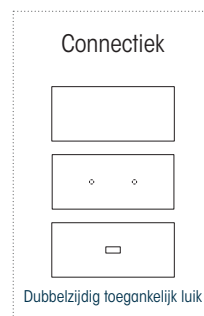
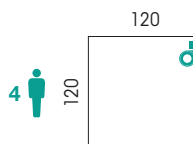
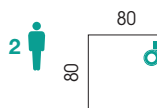

Kleurenkaart

Melamine

Bladdikte 25 mm



MG

N5



MA

R2



RI

R3

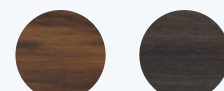

N6

M9



MK

Zwart melamine met fluweelstructuur

Metaal

Onderstel



SO



SA



SC



SG



Ontspannen

Team spirit

Voeg een tafel Ping toe om de medewerkers een sportief en teambuilding moment aan te bieden.

PRIJSLIJST P. 80

Details en levertijden

ALLE INFORMATIE ONLINE!





Robin

Tafel ROBIN, p. 174 - Stoelen ELIOTT
p. 216 - Kast ARMAND, p. 140

ZACHTE EN NATUURLIJKE LIJNEN

ROBIN is een knipoogje naar een huiselijke stijl en valt vooral op met zijn elegante massief beuken poten. Die zijn licht afgerond en voegen een warme toets toe aan de werkomgeving. Een erg compleet aanbod voor zowel het managementkantoor en de co-working spaces als de vergaderruimte.

Productie
in Frankrijk



Robin bestaat ook in bureauversie, zie p. 96



Trendy & Functioneel

Standaard hoogte
H. 73,5 cm



Hoge tafels
H. 104,5 cm



Oplossingen voor kabelgeleiding

Kabeldoppen voor rechtstreekse aansluiting of dubbelzijdig toegankelijk luik

Comfortabel

Voetensteun met stabiliteitskabels

Kleurenkaart

Melamine
Bladdikte 25 mm



Metaal
Onderstel



Hout
Onderstel



Overzicht

Rechthoekige tafels
H. 73.5 en 104.5 cm

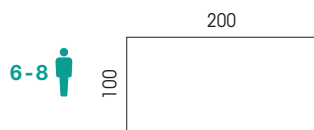
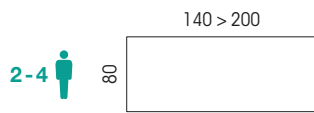

Vierkante tafels
H. 73.5 en 104.5 cm

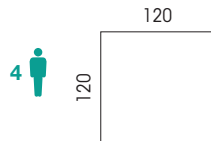
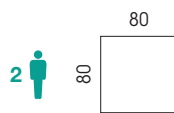

Ronde tafel
H. 73.5 en 104.5 cm

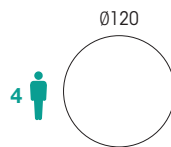

Connectiek

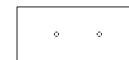

Dubbelzijdig toegankelijk luik

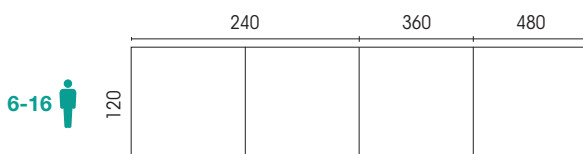

PRIJSLIJST P. 83
Details en levertijden

ALLE INFORMATIE ONLINE!





E-meeting

GECONNECTEERD VERGADEREN

E-MEETING speelt ten volle in op de nieuwe manieren van werken en biedt een volledige oplossing voor presentaties of videoconferenties. De multimediawand bevat alle vereiste connectiek en kan voorzien worden van een videoscherm zonder zichtbare kabels. Aan de tafel met technische luiken kunnen de deelnemers comfortabel connecteren. Een pasklare oplossing voor de nieuwe hybride werkmethodes. Ordelijk en geconnecteerd.

Productie
in Frankrijk





Modern & Geconnecteerd

Multimediawand

Voor videoscherm of flatscreenhouder.
Geïntegreerde kabelgeleiding



Kleuren- kaart

Melamine
Bladdikte 38 mm
Multimediawand
dikte 19 mm



MG

Metaal
Ronde poot, frame
multimediawand



SO



SA



SG

Keuze van de werkpositie

Hoog H. 105 cm of standaard
H. 73,5 cm

Inclusief metalen goot

In de kleur van het onderstel



Overzicht

Afgerond blad

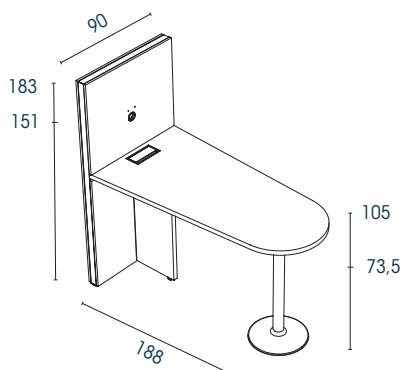

(Ronde poot met vloerplaat)

Trapeziumvormig blad

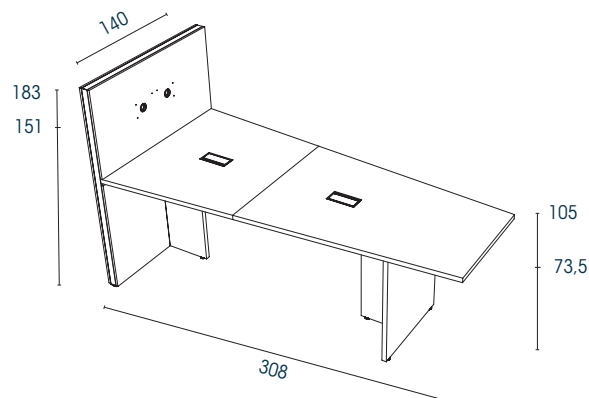

(Paneelpoot)

PRIJSLIJST P. 85
Details en levertijden

**ALLE INFORMATIE
ONLINE!**





Ping

DE VERGADERTAFEL DIE EEN SPORTIEVE GEEST CULTIVEERT

Ernstig werken staat ontspannen niet in de weg. De tafel PING kan na een vergadering omgebouwd worden voor een toernooi! Ze biedt plaats aan 6 personen en kan met de meegeleverde kit in een oogwenk omgebouwd worden tot een pingongtafel. De zachte kleuren zorgen voor een moderne en warme stijl.

Productie
in Frankrijk





Werken & Ontspannen

Omgebouwd in een oogwenk

Uittrekbaar net met verstelbare klemmen naargelang de bladdikte



Inclusief Ping-Pongkit

(1 net, 2 pallets en 2 balletjes)



Slijtvast

Schok- en krasbestendig (melamine blad)

Zachte en natuurlijke tinten

Creëren een sfeer van ontspannen betrokkenheid (poten van massief beuken)

[o] Optie



Opberglade voor de pingpongkit (optie)

Kleurenkaart

Melamine

Bladdikte 25 mm



M7*

* Witte stootranden

Metaal/Hout

Onderstel



ZOMS

PRIJSLIJST P. 86

Details en levertijden

ALLE INFORMATIE ONLINE!





Martin

ONTWORPEN VOOR FLEXIBELE RUIMTES

Brainstormen, van gedachten wisselen, een presentatie bijwonen: MARTIN voelt zich thuis in elke situatie. Tegelijkertijd multimediamuur, whiteboard en opbergruimte. Veelzijdig in gebruik, maar letterlijk dan.

Productie
in Frankrijk





Makkelijk verrijdbaar. Geïntegreerde bekabeling en aansluitingen, voor een geordende werkomgeving. Doordacht meubilair waarmee elke ruimte in een handomdraai wordt getransformeerd.



Mobiel & Geconnecteerd

Dubbelzijdig
Met opbergvak



Enkelzijdig
Multimedia



Dubbelzijdig
Met poefs ZELIE



Mobiel

Makkelijk verrijdbaar op 4 wielen waarvan 2 met rem (alle vloertypes)
De stijlen dienen als handgrepen

Geconnecteerd

- Geïntegreerde schermhouder tot 55 inch
- Stopcontact in het frontpaneel
- Discrete kabelgeleiding dankzij de afneembare achterwanden

Magnetisch whiteboard

Droog afveegbaar, magneetband bovenaan

[] Zooms



Whiteboard
Met geïntegreerde houder



Riem met clips
Voor het opbergen van poefs ZELIE



Overzicht

Enkelzijdig

Multimedia

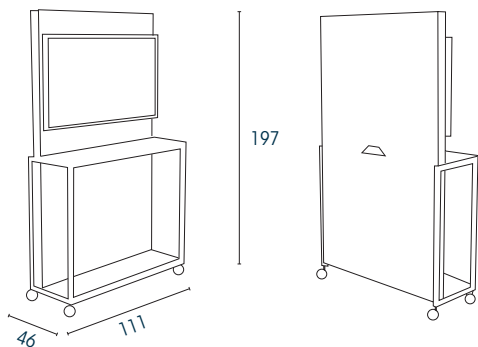

Dubbelzijdig

Met gesloten opbergvak

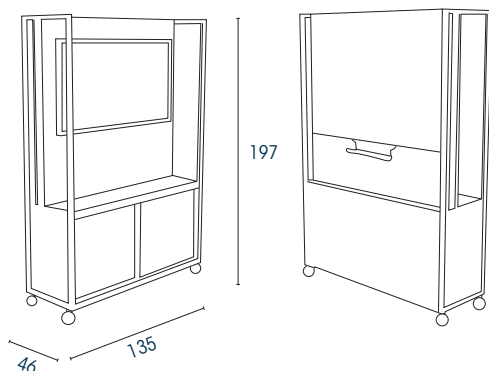

Recto: Multimedia + opbergvak (2 schuifdeuren)
Verso: whiteboard

Open uitvoering

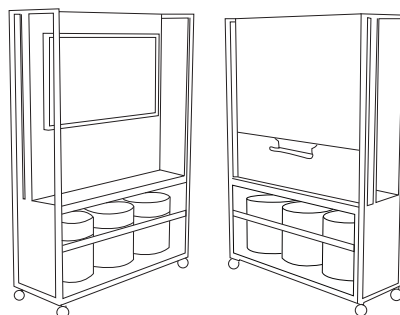

Recto : Multimedia + open opbergvak (poef ZELIE optioneel)
Verso: whiteboard

Kleuren-kaart

Melamine
Opbergvak en
legborden, panelen
dikte 19 mm

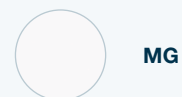

MG



MK

Centraal paneel



RI



R3



N6

Metaal
Structuur



ZO



ZP



**Haken om kabels
op te rollen**
Aan weerszijden

PRIJSLIJST P. 86

Details en levertijden

**ALLE INFORMATIE
ONLINE!**





Chatbox

MEER DAN EEN CABINE...STIJLVOLLE EFFICIENTIE

CHATBOX is het alternatief voor klassieke vergaderruimtes. Ze worden temidden van de co-working space geplaatst, nemen weinig ruimte in en bieden de medewerkers een cocon waar ze zich kunnen concentreren, brainstormen of gewoon telefoneren zonder de anderen te storen. Een innovatieve oplossing voor een serene en productieve co-working space.





Stil & Geconnecteerd

Efficiënte en stille ventilatie

Van het plafond naar de vloer

Omkeerbare deur

Opent rechts of links (te kiezen bij de installatie).
Magneetsluiting



Geconnecteerd

Geïntegreerde bekabeling
(stopcontact + USB-A en USB-C
porten)

Ledverlichting

Met bewegingssensor

Decoratief

Zijpanelen van wit of zwart
metaal (geschikt voor
magneetbevestiging)

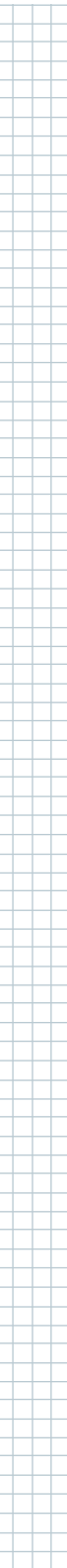



↑
Kruk TOM, p.224

Chatbox samenstellen



TELEFONEREN

Voeg een kruk TOM toe voor actief zitten en rustig een telefoongesprek te kunnen voeren



ZICH CONCENTREREN

Zich even afzonderen om zich te concentreren binnen de co-working space. In de versie met elektrische hoogteregeling kan zittend of staand gewerkt worden



Overzicht

Stiltecabines

CB1



1 Met blad

CB2

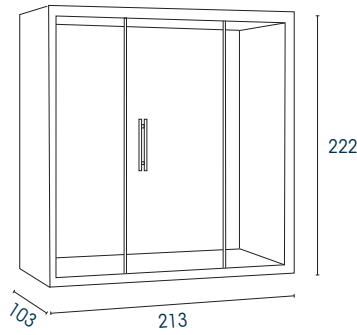

1-4 Leeg
Met centrale tafel/vaste poot
Met laterale tafel/epoot met elektrische
hoogteregeling

CB4

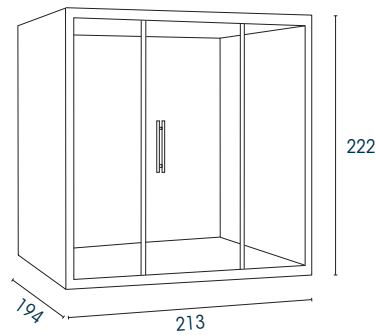

4-6 Leeg
Met centrale tafel/vaste poot

Kleuren- kaart

Metaal
Zijwanden,
monderstellen



SO



SG

Stof
Zitbanken



FU
Donkergrijs

Opties



2-zitsbank



Centrale tafel



Flatscreenhouder



VERGADEREN

Met 2, 4 of 6 personen, geïntegreerde connectiek zodat niemand de draad kwijtgeraakt!

PRIJSLIJST P. 87
Details en levertijden

**ALLE INFORMATIE
ONLINE!**





Klaptafels

Overzicht

Rechte bladen

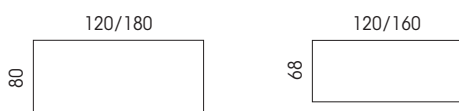

Halfronde aanbouwbladen

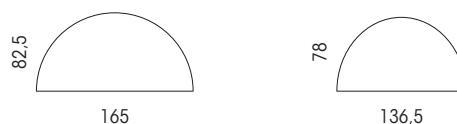

Productie
in Frankrijk





Praktisch & Verplaatsbaar

Veelzijdig

Ideaal voor vergaderruimtes en opleidingslokalen

Samenstelbaar

Eenvoudig en snel systeem om de ruimte makkelijk in te richten



Stoffen frontpaneel

(Optie)

Mobiel

4 wielen met rem
(alle vloertypes)

Kleurenkaart

Melamine

Bladdikte 19 mm



MG



N5



MA



R2



RI



R3



N6



M9



MK

Fluweel-zwart melamine

Metaal

Onderstel



SO



SA



SG

[] Snel en makkelijk geïnstalleerd



↑
Snel en veilig opklappen



↑
Koppelen zonder gereedschap
Met draaiwielen (inbegrepen)



↑
Plaatsbesparend opbergen
Nestbaar in opgeklapte positie

PRIJSLIJST P. 88

Details en levertijden

ALLE INFORMATIE ONLINE!





Emi

+ Mobiel & Flexibel



Unieke stijl

Zelfde design voor tafels en stoelen
Stootrand in de kleur van het frontpaneel

Zin voor detail

Verchromd onderstel en wielen

Plaatsbesparend

Nestbare tafels

Mobiel

Wielen voor zachte en harde vloeren

Kleurenkaart

Melamine

Wit blad/zwarde rand, dikte 25 mm



MM

Metaal

Onderstel



SQ



Gebuiksvriendelijke kantelhandgreep



Bij de tafel passende stoelen EMI, zie P.240

Productie
in Frankrijk



Antibacterieel
oppervlak

PRIJSLIJST P. 113
Détails en levertijden
**ALLE INFORMATIE
ONLINE!**





Polyvalente tafel

+ Budgetvriendelijk & functioneel



.....
**Antraciet draagframe, poten
voorzien van steldoppen**

.....
Diverse opstellingen
Recht, halfrond of trapeziumvormig blad

Kleurenkaart

Melamine

Bladdikte 19 mm



MG



N5



R2



RI

Metaal

Onderstel



SO



SA



SC

Productie
in Frankrijk



Antibacterieel
oppervlak



PRIJSLIJST P. 89
Détails en levertijden

**ALLE INFORMATIE
ONLINE!**





Kleuren- kaart

Melamine
Bladdikte 25 mm



MG



N5



MA



R2



RI



R3



N6



M9



MK

Fluweelzwart
melamine

Metaal
Onderstel



SA

Tafel met vrije beenruimte

+ Licht & Modulair



Onderstel voor vrije beenruimte
Optimale bewegingsvrijheid

Ronde, vierkante of
rechthoekige tafel
H.73,5 cm

Overzicht

Rechthoekige tafel

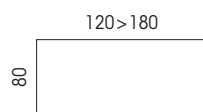

Vierkante tafel

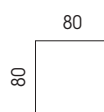

Ronde tafel

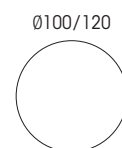

Hoek 90°

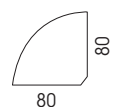

PRIJSLIJST P. 91

Details en levertijden

ALLE INFORMATIE
ONLINE!



Productie
in Frankrijk



Antibacterieel
oppervlak





Vouwtafels

+ Makkelijk op te bergen



Modulair

Rechthoekige en halfronde tafels
H. 72 cm

Stootrand in de kleur van het blad

Productie
in Frankrijk



Vrijstaand

Rechthoekige tafels

Dubbele metalen versterkingsstang
onder het blad



Optie : Transport- wagen

Om tafels te transporteren en op te bergen

Capaciteit:
10 vouwtafels,
20 stoelen met 4 poten of 14 vouwstoelen

Inclusief veiligheidsriem om vouwstoelen
op hun plaats te houden



Kleuren- kaart

Melamine
Bladdikte 25 mm



MG



N5



R2



RI

Metaal
Onderstel



SQ

Melamine
Bladdikte 18 mm



GR
Lichtgrijs

Metaal
Onderstel



SG

PRIJSLIJST P. 91

Details en levertijden

**ALLE INFORMATIE
ONLINE!**





Eloise

LUNCHEN OF VERGADEREN IN STIJL!

De vrijstaande tafels ELOISE lenen zich zowel voor vergaderruimtes als bedrijfsrestaurants. Ruime keuze uit poottypes en bladvormen.

Productie
in Frankrijk





Praktisch en robuust, deze meubellijn biedt altijd een gepast antwoord. ELOISE kan ook voorzien worden van oplossingen voor kabelgeleiding in de vergaderruimte.



Overzicht

Ronde tafels



Melamine dikte 25 of 38 mm
Laminaat (alleen ø120 cm)

Vierkante tafels

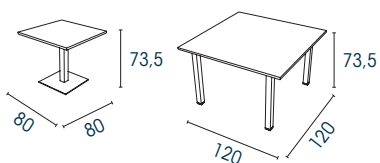

Melamine dikte 25 of 38 mm
Laminaat
(alleen voor tafel met centrale poot)

Tonvormige tafels

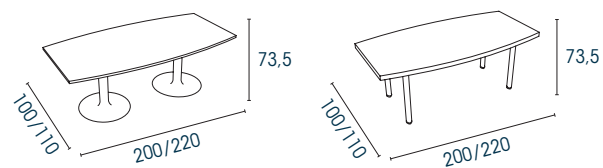

Melamine dikte 25 of 38 mm

Rechthoekige tafels

Melamine dikte 38 mm

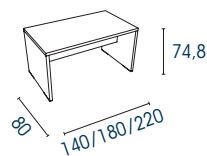
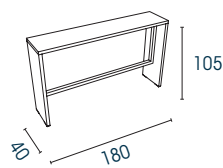
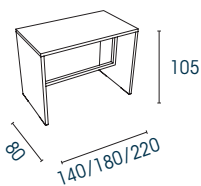
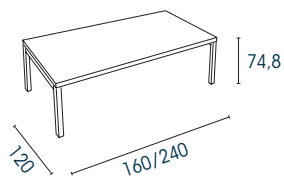

Zitbank

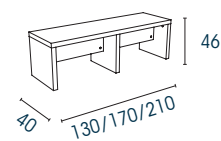

Snacktafels

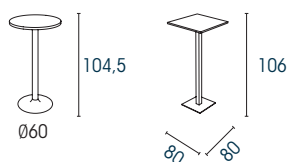

Melamine dikte 25 mm
of laminaat



Een tafel voor elke toepassing!



Kleurenkaart

Melamine

Bladdikte 25 mm of 38 mm*



MG



N5



MA



R2



RI



R3



N6



M9



MK

Fluweel-zwart melamine

* Bladdikte 38 mm enkel leverbaar in MG, RI, N6, M9

Laminaat

Bladdikte 23,6 mm



HZ



VW

Metaal

Onderstel



SO



SA



SC



SG

PRIJSLIJST P. 92

Details en levertijden

ALLE INFORMATIE ONLINE!



Diverse vormen

- Vierkante, ronde of rechthoekige tafel
- Snacktafel voor koffiepauzes

Aangepaste materialen

- Laminaat
- Voor restaurants (hogere vlek-en krasbestendigheid)
- Melamine
- Voor vergaderruimtes

Veranderen van werkpositie

- Hoge versies H. 105/106 cm
- Of standaard H. 73,5/74,8 cm

Veelzijdig

- De tafels zijn geschikt voor vergaderruimtes en/of bedrijfsrestaurants.
- De hoge tafel D 40 cm vormt een tussenruimte om iets te eten of te werken

Geconnecteerd

- Tafel met of zonder uitsparingen naargelang de versies:
- Kabeldoppen op ronde en vierkante tafels
- Luiken op rechthoekige en tonvormige tafels (behalve versie met paneelpoten)



Evasion

NATUURLIJKE UITSTRALING!

Een geslaagd huwelijk tussen metaal en naturel beuken. EVASION maakt het verschil met grafische en ranke lijnen. Een compleet aanbod van tafels en bijpassende stoelen.

Productie
in Frankrijk





EVASION is leverbaar in verschillende vormen en afmetingen en is zowel geschikt voor bedrijfsrestaurants als vergaderruimtes.



Kleuren-kaart

Laminaat

Bladdikte 23,6mm



HZ



VW

Metaal/Hout

Onderstel



ZOMS



ZPMS

Evasion

+ Modern & Natuurlijk



Natuurlijke stijl

Poten van massief beuken

Diverse opstellingen

Ronde of rechthoekige tafels

Veranderen van werkpositie

Hoge versies H.105 cm of H. 73,5 cm

Slijtvast en afwasbaar

Bladen bekleed met vlek- en krasbestendig laminaat

Zooms



Metalen insert

Wit of zwart, passend bij het blad



Multiplex stootrand

Decorbeuken

PRIJSLIJST P. 94

Details en levertijden

ALLE INFORMATIE ONLINE!





Clara

+ Onderstel met speelse lijnen!



Aangepaste materialen

Laminaat

- Voor restaurantruimtes (slijtvaster)

Melamine

- Voor vergaderruimtes

Eigentijdse stijl

Onderstel met gekruiste structuur voor een lichtere uitstraling

Veranderen van werkpositie

Hoge versies H.105 cm of H.73,5 cm

Kleurenkaart

Melamine

Bladdikte 25 mm



MG



N5



MA



R2



RI



R3



N6



M9



MK

Fluweel-zwart melamine

Laminaat

Bladdikte 23.6 mm



HZ



VW

Metaal

Onderstel



ZO



ZP

PRIJSLIJST P. 94

Details en levertijden

ALLE INFORMATIE ONLINE!





Lucie

+ Puristisch stijl outdoor of indoor



Verschillende versies :

- 2 hoogtes 73,5 en 105cm
- 1 bladformaat: 60 x 60cm

Indoor gebruik

Metalen poot en melamine blad

Outdoor gebruik

Metalen blad en poot, behandeld tegen corrosie

Kleurenkaart Indoor

Metaal
Onderstel



ZP

Melamine
Blad dikte 25 mm



MG



N5



MA



R2



RI



R3



N6



M9



MK*

Outdoor

Metaal
Blad*, onderstel



ZP SG

Productie
in Frankrijk



* MK Fluweelzwart melamine ** Metaal dikte. 3 mm

PRIJSLIJST P. 95
Détails en levertijden

**ALLE INFORMATIE
ONLINE!**





Iris

+ Makkelijk op te bergen outdoor product



Verschillende versies

- 2 hoogtes : 73 of 110 cm
- 1 bladformaat : ø 69 cm

UV-en vochtbestendig

Blad en metalen onderstel behandeld tegen corrosie met UV-bestendige lak

Makkelijk op te bergen

Vaste tafel of klaptafel

Kleurenkaart

Metaal

Onderstel, blad



SO



Gebruiksvriendelijke kantelhandgreep

Productie
in Frankrijk



PRIJSLIJST P. 95
Détails en levertijden

**ALLE INFORMATIE
ONLINE!**







Bureaustoelen





Bureaustoelen



Seven
Excentrisch
kantelend

DIRECTIE

Pagina 210 ›



Attitud
Synchroon
ergonomisch

DIRECTIE

Pagina 211 ›



Elton
Excentrisch
kantelend

DIRECTIE

Pagina 212 ›



Manhattan
Excentrisch
kantelend

DIRECTIE

Pagina 213 ›



Harly
Excentrisch
kantelend

DIRECTIE

Pagina 213 ›



Coach
Synchroon comfort of
ergonomisch

ERGONOMISCH

Pagina 214 ›



Opus
Synchroon comfort, ergo-
nomisch of ergo +

ERGONOMISCH

Pagina 215 ›



Eliott
Synchroon zelfregelend of lateraal
Regelbare zitdiepte

ERGONOMISCH

Pagina 216 ›



Leon
Synchroon lateraal of
ergonomisch

ERGONOMISCH

Pagina 218 ›



Oscar

Synchroon zelfregelend
comfort of ergonomisch

ERGONOMISCH

Pagina 220 ›

.....



Alter

Synchroon

OPERATIONEEL

Pagina 222 ›

.....



Mia

Permanent
contact

OPERATIONEEL

Pagina 223 ›

.....



Tom

Actief zitten, 360°
draaibaar

ZITTEND / STAAND

Pagina 224 ›

.....



Globe XXL

Synchroon
ergonomisch

POLYURETHAAN

Pagina 226 ›

.....



24H Pro

Excentrisch
kantelend

INTENSIEF

Pagina 226 ›

.....



Polyurethaan

Regelbare zithoogte, slijtvast

TECHNISCH

Pagina 227 ›

.....



Universeel

Regelbare zithoogte

Pagina 227 ›

.....



85%

van de in 2010 gerapporteerde beroepsziekten hielden verband met musculoskeletale aandoeningen en lage rugpijn

Het belang van een juiste zithouding

Voor elke lichaamsbouw en toepassing bestaat een aangepaste stoel. Eenmaal de stoel gekozen, blijft een juiste instelling belangrijk. Een goed ingestelde stoel vermindert het risico op spierpijn, musculoskeletale aandoeningen en rugproblemen.

Zitcomfort

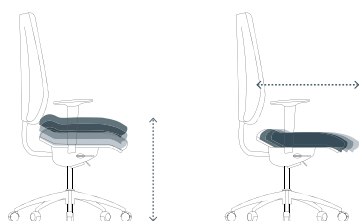

Instelling van de hoogte en de diepte van de zit

Rugcomfort

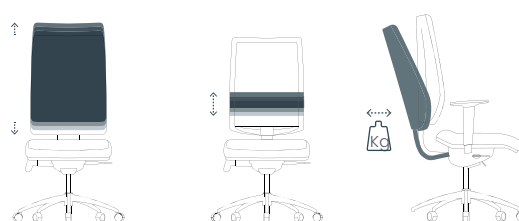

Instelling van de hoogte van de rug en/of de lendesteun, de neigingshoek en de weerstand van de rug



De stoelmechanismen van EOL



Permanent contact

De rugleuning kantelt onafhankelijk van de zit

De rugleuning volgt de bewegingen van de rug en blijft zo in "permanent contact", terwijl de zit stabiel blijft.



Kantelend

De zit en de rug kantelen synchroon naar achter in een constante hoek. Er bestaan 2 types van kantelmechanismen :

1 – Centraal kantelend: het rotatiepunt bevindt zich in het midden onder de zit

2 – Excentrisch kantelend: het rotatiepunt bevindt zich meer naar voor onder de zit voor soepelere kantelbewegingen

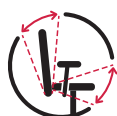

Synchroon

De rugleuning kantelt synchroon met de zit, maar in een verschillende hoek.

Hierdoor ontstaat een optimaal contactoppervlak met de stoel en worden de wervelkolom en het bekken maximaal ondersteund. Dit is de meest ergonomische oplossing.

Zelfregelend voor een automatische regeling van de weerstand van de rug

Comfort of Lateraal: zonder regelbare zitdiepte. De weerstand van de rugleuning wordt geregeld met een draaiwiel vooraan of opzij.

Ergonomisch: met regelbare zitdiepte. De weerstand van de rug wordt geregeld met een hendel opzij.

Ergo+: dezelfde regelmogelijkheden als de ergonomische versie, maar met een groter bereik en een negatieve zitregeling.

Nekcomfort



Een hoofdsteun als optie
Naargelang het model, regelbaar in hoogte en neigingshoek

Schoudercomfort

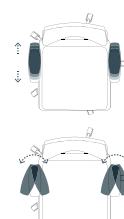
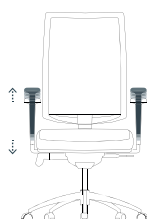

Kies een stoel met armleuningen

1D : Regelbaar in hoogte
3D : Regelbaar in hoogte, breedte en diepte
4D : Regelbaar in alle richtingen én draaibaar



Seven

+ Statig & eigentijds



Eigentijds

Strakke en moderne lijnen

Ondersteuning van de nek

Ruime vaste hoofdsteun biedt ondersteuning van de nekwevels

Afwerkingsdetails

Verchromde vaste armleuningen

Kleurenkaart

Leder

Bureaustoel



YB

Kunstleder

Stoel



YA

Aluminium

Onderstel



SQ

Verchromd

Mechanisme



Excentrisch kantelend



PRIJSLIJST P. 98
Détails en levertijden

**ALLE INFORMATIE
ONLINE!**





Attitud

+ Verzorgd tot in de details



Nekcomfort

Ruime vaste hoofdsteun biedt ondersteuning van de nekwerfels

Rugcomfort

In hoogte verstelbare rug (+ 6 cm)

Zitcomfort

Brede en comfortabele zit (51 cm)

Afwerkingsdetails

Rug aan weerszijden bekleed. 4D armleuningen en soft touch armsteunen

Kleurenkaart

Leder

Zit en rug



YB

Stof

Zit en rug



Cat. A
BONDAÏ



Cat. B
STEP / STEP
MÉLANGE / CHILI



Cat. C
SECRET

Nylon / Aluminium

Onderstel



SV
Noir



SQ
Chromé

Mechanisme



Synchroon

Productie
in Frankrijk



PRIJSLIJST P. 98
Détails en levertijden
**ALLE INFORMATIE
ONLINE!**





Elton

+ Transparantie troef!



Veelzijdig

Geschikt voor werkomgeving en vergaderruimtes



Soepel comfort

- Stoel volledig uitgevoerd in mesh, van de rug tot de zit
- Soepele rugleuning, volgt de bewegingen van de rug

Zitcomfort

Afgeronde zit, vooraan gevuld voor extra comfort

Kleurenkaart

Mesh

Zit en rug



TI

Mechanismen



Excentrisch kantelend (bureaustoel)



Kantelend (stoel)



PRIJSLIJST P. 99
Détails en levertijden

ALLE INFORMATIE
ONLINE!





Manhattan



Afwerkingsdetails

Verchroomde vaste armleningen met soepele armsteunen



Nek comfort

De ruime vaste hoofdsteun biedt ondersteuning van de nekwerfels

Harly



Afwerkingsdetails

Verchroomde vaste armleningen met soft touch armsteunen



Nekcomfort

Ruime vaste hoofdsteun biedt ondersteuning van de nekwerfels

Kleurenkaart

Leder
Volnerf leer
Zit en rug



YB
Zwart



YC
Wit

Mechanisme



Excentrisch kantelend

PRIJSLIJST P. 99

Détails en levertijden

ALLE INFORMATIE ONLINE!



Kleurenkaart

Leder
Splitleder
Zit en rug



YB
Zwart

Mechanisme



Excentrisch kantelend

PRIJSLIJST P. 99

Détails en levertijden

ALLE INFORMATIE ONLINE!



Coach

+ Elegantie & extra comfort



Nekcomfort

Stoffen model Kantelbare (30°)
en in hoogte verstelbare hoofdsteun
(+ 6 cm)

Zitcomfort

Zit vooraan afgerond om de bloedsomloop
te bevorderen

Rugcomfort

- Rug met stof in hoogte regelbaar (+ 6 cm)
- Dossiers résille avec soutien lombaire (+ 6 cm)

Kleurenkaart

Stof

Zit en rug



Cat. A
BONDAl



Cat. B
**STEP / STEP
MÉLANGE/CHILI**



Cat. C
SECRET



Cat. E
LEDEr

Mesh

Rug

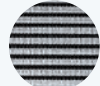

IL

Nylon/Aluminium

Onderstel



SV
Zwart



SQ
Verchroomd

Mechanisme



Synchron

- Comfort
- Ergonomisch met regelbare zittentiepte

Productie
in Frankrijk



Behalve
armleuningen

PRIJSLIJST P. 100

Détails en levertijden

ALLE INFORMATIE

ONLINE!





Opus

+ Een volledig personaliseerbare klassieker



Nekcomfort

Kantelbare (40°) en in hoogte (+6 cm) verstelbare hoofdsteun



Rugcomfort

- In hoogte verstelbaar (rug met stof en mesh + 6 cm)
- Optionele lendesteun (alleen voor mesh rug +11cm)

Zitcomfort

Brede en comfortabele zit (51 cm)

Versie "Ergo +" voor extra comfort

- Negatieve zit
- Verchroomde armleuningen, 360° draaibaar
- Groter regelbereik voor de zit

Kleurenkaart

Stof

Zit en rug



Cat. A
BONDAÏ



Cat. B
**STEP / STEP
MÉLANGE / CHILI**



Cat. C
SECRET



Cat. E
LEDER

Mesh

Rug



IZ

Nylon / Aluminium

Onderstel



SV
Zwart



SQ
Verchroomd

Mechanisme



Synchron

- Comfort
- Ergonomisch met regelbare zitdiepte
- Ergo + met regelbare zitdiepte

Productie
in Frankrijk



PRIJSLIJST P. 101

Détails en levertijden

**ALLE INFORMATIE
ONLINE!**





Eliott

[] 3 types rugleuning



Mesh rug



Rug met stof
(hoge of lage rug)



Gewatteerde rug

Productie
in Frankrijk



Behalve gewatteerde rug en SQ onderstel



Comfort over de hele lijn!

Hoge zit

Versie tekenaarsstoel



Flexplek of persoonlijk gebruik

Mechanisme zelfregelend of aanpasbaar

Zitcomfort

Stevige zit (voorgevormd, dikte 40 mm) Met regelbare zitdiepte

Rugcomfort

Vaste rug met stof of mesh met regelbare lendesteun (+ 6 cm)



Zooms



3D arMLEUNINGEN
soft touch armsteun

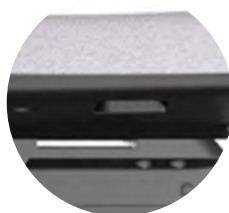

Geïntegreerde regelbare zitdiepte
Regelknop op de zit

Kleurenkaart

Stof - Zit en rug



Cat. A
BONDAÏ



Cat. B
STEP
STEP MÉLANGÉ
CHILI



Cat. C
SECRET



Cat. E
LEDER

Polypropyleen

Rug



Zwart



Wit

Mesh

Rug



IR
Wit



IW
Zwart

Nylon / Aluminium

Onderstel



SV
Zwart



SQ
Verchroomd

Mechanisme

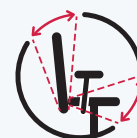

Synchron

- Zelfregelend
- Lateraal
- Geïntegreerde regelbare zitdiepte

PRIJSLIJST P. 102

Détails en levertijden

ALLE INFORMATIE ONLINE!





Léon

[] 3 types rugleuning



◀ **Beklede rug**
voor/achter



◀ **Voorzijde bekleed,**
achterzijde
polypropyleen



◀ **Mesh rug**

Productie
in Frankrijk



◦ Bureaus ARIAL, p.100 - Privacy-panelen SOLANGE, p.116
◦ Tower GUSTAVE, p.128 - Opzetmodule, p.133



Personaliseerbaar

Comfort voor de nek Verstelbare hoofdsteun



Zitcomfort

- Stevig zitcomfort gevormde zit
- Ergonomisch mechanisme met regelbare zitdiepte

Decoratief

De beklede versie voegt een kleurrijke toets toe aan de werkomgeving

Rugcomfort

Intuïtieve hoogteregeling van de rug (+6cm). Mesh rug met geïntegreerde lendesteun (+6cm)

Zooms



ArMLEUNINGEN

1D of 4D met soft touch armsteun



Laterale regeling

Voor hoogteregeling van de rug

Kleurenkaart

Stof

Rug en zit



Cat. A
BONDAÏ



Cat. B
**STEP
STEP MÉLANGE
CHILI**



Cat. C
SECRET

Polypropyleen

Rug



Zwart



Wit

Mesh

Rug



HB
Zwart

Nylon / Aluminium

Onderstellen



SV
Zwart



SQ
gepolijst
aluminium

Mechanisme



Synchroon

- Lateraal
- Ergonomisch met zitdiepte regeling

PRIJSLIJST P. 103

Détails en levertijden

**ALLE INFORMATIE
ONLINE!**





Oscar

[o] 2 types rugleuning



◀
Rug met stof



◀
Mesh rug

Productie
in Frankrijk



Voor beklede rug en mesh rug,
behalve onderstel SQ



Design & comfort tegen een betaalbare prijs

Hoge zit

In de versie tekenaarsstoel



Flexplek of persoonlijk gebruik

Zelfregelend of personaliseerbaar mechanisme

Comfort

Zit met voorgevormd schuim dikte 50 mm

Rugcomfort

- Rug met stof in hoogte regelbaar (+ 7 cm)
- Mesh rug met lendesteun (+ 6 cm)



Zooms



1D of 4D armleuningen

Soft touch armsteun



Lendesteun

Geïntegreerd in de mesh rug

Kleurenkaart

Stof

Zit en rug



Cat. A
BONDAÏ



Cat. B
**STEP
STEP MÉLANGE
CHILI**



Cat. C
SECRET

Polypropyleen

Rug



Zwart



Wit

Mesh

Rug



IW
Zwart

Nylon / Aluminium

Onderstel



SV
Zwart



SQ
Verchromd

Mechanisme

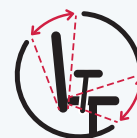

Synchron

- Zelfregelend
- Comfort
- Ergonomisch met regelbare zitdiepte

PRIJSLIJST P. 104

Détails en levertijden

**ALLE INFORMATIE
ONLINE!**





Alter



Keuze uit verschillende opties

- Rug met stof of mesh
- Vaste of 1D arMLEUNINGEN

Zachte vloeren

Wielen Ø 50 mm

Praktisch

Kledinghaak op de rug

Kleurenkaart

Stof

Zit en rug



KE



KC

Mesh

Rug



TI

Nylon

Onderstel



SV
Zwart

Mechanisme



Synchron

PRIJSLIJST P. 105

Détails en levertijden

ALLE INFORMATIE
ONLINE!





Mia



.....

Rug in hoogte verstelbaar

Met regelwiel (+ 7 cm) permanent contact
+ 7 cm)

.....

Vaste arMLEUNINGEN

Kleurenkaart

Stof

Zit en rug



BI
Zwart



BE
Blauw



SV
Zwart

Nylon

Onderstel

Mechanisme



Permanent
contact

PRIJSLIJST P. 105

Détails en levertijden

**ALLE INFORMATIE
ONLINE!**





Tom

VERANDER VAN ZITHOUDING OP EEN LUDIEKE MANIER!

TOM is een ludiek antwoord op hedendaagse zitbehoeften, bijvoorbeeld bij het wachten, telefoneren, een koffie drinken of korte informele vergaderingen. Eveneens ideaal voor een rustmoment bij staand werk.





Actief & ludiek

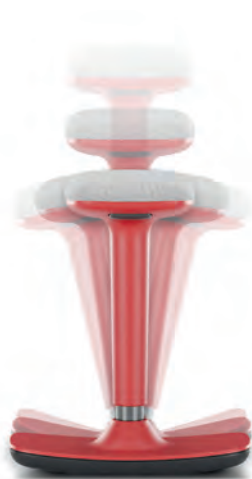

Actief zitten

Kantelende vloersteun om statisch zitten te vermijden en de onderrug in beweging te houden

Praktisch

Kan makkelijk verplaatst worden

Staand of half staand

Regelbare zithoogte (tussen 53 en 76 cm)

Draaibare zit

360°

Kleurenkaart

Stof

Zit



Cat. A
BONDAÏ



Cat. B
STEP
STEP MÉLANGE
CHILI



Cat. C
SECRET

Nylon

Onderstel



SG



ZY

PRIJSLIJST P. 106

Détails en levertijden

**ALLE INFORMATIE
ONLINE!**



Afgeraden voor zit/sta bureaus die een ergonomische bureaustoel vereisen in zittende werkpositie

Kleuren-kaart

Stof

Zit en rug



Cat. A
BONDAÏ



Cat. B
**STEP
STEP MÉLANGE
CHILI**



Cat. C
SECRET

PRIJSLIJST P. 106

Détails en levertijden

ALLE INFORMATIE ONLINE!



Globe XXL



Productie
in Frankrijk

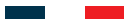

Behalve
armleuningen



Toegelaten gewicht tot 150 kg
(mechanisme met versterkte veer)

Schuimvulling van hoge dichtheid
brandvertragend

Metalen onderstel
Zwart gelakt

Mechanisme



Synchroon
Ergonomisch met
regelbare zitdiepte

Kleuren-kaart

Stof

Zit en rug



UD

PRIJSLIJST P. 106

Détails en levertijden

ALLE INFORMATIE ONLINE!



24H Pro



Intensief gebruik
Stoel 24 / 24U

Slijtvaste stof
brandwerend EN1021-1,2

Toegelaten gewicht tot 150 kg

Mechanisme

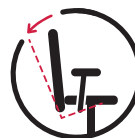

Excentrisch kantelend



Polyurethaan



Specifieke stoelen van polyurethaan (vlekbestendig, bestand tegen chemische inwerking en vonken) voor laboratoria en ateliers.

Regelbare zit

In diepte (+ 5 cm) en in hoogte (24 cm)

Vaste voetensteun

verchromd

Antislip vloerdoppen

Productie
in Frankrijk



Universeel



Bekleding

Zwarte stof Bali

Regelbare zit

In hoogte (10 cm)

Wielen

Zachte vloeren



Kleuren-kaart

Polyurethaan
Zit en rug



PA

PRIJSLIJST P. 107
Détails en levertijden

**ALLE INFORMATIE
ONLINE!**



Kleuren-kaart

Stof
Zit



FA

PRIJSLIJST P. 107
Détails en levertijden

**ALLE INFORMATIE
ONLINE!**





Stoelen



Isabel

DIRECTIE

VERGADEREN

Pagina 230 ›



Inventiv

VERGADEREN

Pagina 232 ›



Elton

DIRECTIE

VERGADEREN

Pagina 234 ›



Romy

VERGADEREN

RESTAURANT

OPLEIDING

Pagina 236 ›



Emi

VERGADEREN

OPLEIDING

Pagina 240 ›



Scott

VERGADEREN

RESTAURANT

Pagina 244 ›



Rosalie

VERGADEREN

RESTAURANT

OPLEIDING

Pagina 246 ›



Meeting+

VERGADEREN

RESTAURANT

OPLEIDING

Pagina 248 ›



Anthra+

VERGADEREN

OPLEIDING

Pagina 249 ›



Geo

VERGADEREN

OPLEIDING

Pagina 249 ›

.....



Evasion

INFORMELE RUIJMT

RESTAURANT

Pagina 250 ›

.....



Sofia

INFORMELE RUIJMT

RESTAURANT

Pagina 252 ›

.....



Tara

INFORMELE RUIJMT

RESTAURANT

Pagina 254 ›

.....



Line

OUTDOOR

RESTAURANT

Pagina 256 ›

.....



Gelati

OUTDOOR

RESTAURANT

Pagina 258 ›

.....



Spoon

RESTAURANT

Pagina 260 ›

.....



Tic

RESTAURANT

Pagina 261 ›

.....



Isabel

DE ONMISBARE BEZOEKERSSTOEL

ISABEL werd speciaal ontworpen voor vergaderruimtes en managementbureaus. Het is een stoel met een resoluut tijdloos design, leverbaar met lage of hoge rug, met slede- of conferentieonderstel, maar altijd met maximaal comfort. Voegt in elke omgeving een elegante meerwaarde toe.

Productie
in Frankrijk





Elegant & comfortabel

Rug met stof of mesh

Esthetische of comfortkeuze
(een rug met mesh is ademend)



Afwerkingsdetails

Rug aan weerszijden bekleed



Veelzijdig

Werkomgeving of
vergaderruimtes

Stevig en duurzaam comfort

(voorgevormd schuim,
dikte 50 mm)

Verschillende onderstellen

- Verend sledeonderstel
- Conferentiepot (kruis of op wielen) met kantelmechanisme

Kleuren- kaart

Stof

Zit en rug



Cat. A
BONDAÏ



Cat. B
STEP
STEP MÉLANGE
CHILI



Cat. C
SECRET

Leder

Zit en rug



YB
Zwart

Mesh

Rug



IN
Zwart

Metaal

Poten



SB
Grijs alu



SG
Zwart



SQ
Verchroomd

PRIJSLIJST P. 110

Détails en levertijden

ALLE INFORMATIE ONLINE!





Klassiek of kleurrijk



Inventiv'

Veelzijdig

Bureau, vergaderruimte of opleidingslokaal

Rug met stof of mesh

Esthetische of comfortkeuze (een rug met mesh is ademend)

Vast of mobiel

Wielen voor harde vloeren, ø 40 mm

Gevarieerde afwerkingen

Witte of zwarte mesh, onderstel in 3 kleuren

Productie
in Frankrijk



4 poten vast



Met
schrijfplateau



Sledeon-
derstel



2
jaar



35
%



Kleuren-kaart

Stof

Zit en rug



Cat. A
BONDAÏ



Cat. B
STEP
STEP MÉLANGE
CHILI



Cat. C
SECRET

Mesh

Rug



UH
Zwart



UM
Wit

Metaal

Poten



SP
Wit



SB
Grijs



SG
Zwart



Zooms



Armleuning met schrijfplateau
rechts



Transportwagen
Om tot 6 stoelen met 4 poten
te stapelen

PRIJSLIJST P. 111
Détails en levertijden

**ALLE INFORMATIE
ONLINE!**





Elton

EEN GESLAAGD HUWELIJK TUSSEN ERGONOMIE, TECHNOLOGIE EN DESIGN

ELTON is volledig uitgevoerd met comfortabele mesh, van zit tot rug. Een slijtvaste technologie die comfort en een strakke stijl toevoegt aan vergaderruimtes of directiekantoren.





Transparant & comfortabel!

Vaste armleuningen



Alle vloertypes Wielen
voor zachte of harde vloeren,
ø 65 mm

Soepel comfort

Volledig bespannen met mesh,
van de zit tot de rug

Zitcomfort

Gevormde zit met vulling vooraan
voor meer comfort

Rugcomfort

Soepele rug die de bewegingen
van de gebruiker volgt

Kleuren- kaart

Mesh
Zit en rug



TI
Zwart

Kunststof
Poten



SV
Zwart

Mechanisme
Rug



Kantelend

PRIJSLIJST P. 99

Détails en levertijden

**ALLE INFORMATIE
ONLINE!**





Romy

DE VERANTWOORDE EN MODERNE STOEL

ROMY is gebaseerd op een innovatief concept voor een assemblage zonder schroeven en gereedschappen, dankzij een modulair montagesysteem. Een intelligente oplossing die recycling vereenvoudigt en veelzijdigheid qua gebruikstoepassingen en kleuren oplevert.

Productie
in Frankrijk



Polypro-
pyleen zit



Met gestof-
feerde zit



Polypro-
pyleen zit



Met gestof-
feerde zit



GARANTIE
2
jaar



26
%



Mobiel of vast, met of zonder arMLEUNINGEN, met of zonder schrijfplateau, ROMY is volledig personaliseerbaar. De vorm van de zit en de rug is ontworpen voor onmiddellijk comfort voor de gebruiker.



Verantwoordelijk & modern



Veelzijdig

Zowel geschikt om te werken en te vergaderen, als voor opleidingen en bedrijfsrestaurants

Versies

- Mobiel of vast
- Met of zonder schrijfplateau
- Optioneel zitkussen

Veelkleurig

Stoel in één of twee kleuren : de kleuren van poten en zit kunnen gevarieerd worden



In de polypropyleen versie is ROMY vervaardigd uit 100% recycleerbare materialen (zit en poten)

- De zit, de rug en de armleningen bevatten 63% gerecycleerd materiaal
- Gemonteerd zonder schroeven en makkelijk te demonteren



Kleuren-kaart

Stof

Zitkussen

Cat. A
BONDAÏCat. B
STEP
STEP MÉLANGE
CHILICat. C
SECRET

Polypropyleen

Rug, zit, armleningen

**PX** Grijs**PT** Wit**PU** Zwart**PW** Geel**PZ** Rood

Metaal

Poten

**SB** Grijs**SP** Wit**SG** Zwart**SX** Geel**ZY** Rood

* Kleur van de zit, de rug en de armleningen identiek. Mogelijkheid om de kleur van de poten te variëren



Onmiddellijk Comfort

Brede zit en voorgevormde rug

Praktisch

- Slijtvaste en afwasbare stoel
- Stapelbaar (tot 15 stoelen op rolwagen)

Afneembaar schrijfplateau

Zonder gereedschappen

Opties



Koppelstuk

Voor stoel zonder armleningen



Voor stoel met armleningen

PRIJSLIJST P. 112

Détails en levertijden

ALLE INFORMATIE ONLINE!





Emi

FLEXIBEL EN VEELZIJDIG!

EMI werd speciaal ontworpen voor flexibel en polyvalent gebruik. Doordacht concept om de werk-, vergader- of opleidingsomgeving in een handomdraai in te richten.

Productie
in Frankrijk



Polypropyleen zit
Vaste of verrijdbare
poten



Beklede zit
Vaste poten



Beklede zit
Verrijdbare poten





Vaste of verrijdbare stoelen die moeiteloos verplaatst worden. De tafels en stoelen worden makkelijk dichtgeklapt om ze op te bergen. Horizontaal nestbaar en verticaal stapelbaar tot 20 stuks, EMI is dé plaatsbesparende oplossing.



Stapelbaar en nestbaar





Mobiel & flexibel



Veelzijdig

Werkomgeving, vergaderruimte of opleidingslokaal



Diverse opties

- Vaste of opklapbare zittingen
- Met of zonder armleuningen
- Met of zonder wielen



Plaatsbesparend opbergen

Horizontaal nestbaar of verticaal stapelbaar (tot 20 stoelen)



Onmiddellijk comfort

Voorgevormde schuimvulling

Kleurenkaart

Stof

Zit en rug*



Cat. A
BONDAÏ



Cat. B
STEP
STEP MÉLANGE
CHILI



Cat. C
SECRET

* Stof op basis van zwart polypropyleen PU

Polypropyleen

Zit en rug



PU
Zwart

Mesh

Rug



UH
Zwart

Metaal

Poten



SQ
Verchroomd

PRIJSLIJST P. 113

Détails en levertijden

ALLE INFORMATIE ONLINE!





Scott

NIEUW

EEN COSY EN BUDGETVRIENDELIJKE STOEL

Met zijn omhullende rugleuning biedt SCOTT een geweldig zitcomfort en is hij een elegante meerwaarde voor elke ruimte. SCOTT is verkrijgbaar met 4 poten in polypropyleen, hout, houtvezel of met conferentiepot op wielen, met keuze uit 7 kleuren, waarvan 3 gemaakt uit 100% gerecycled materiaal. Scott past in elke ruimte en stijl. SCOTT ook volledig gestoffeerd verkrijgbaar in 47 stoffen.

Productie
in Frankrijk





Omhullend & multifunctioneel



Poten **in houtvezel**

Comfortabele, ondersteunende zitting
Volledig gestoffeerde versie

Meerdere ruimtes
Werk-, catering-, vergader- of informele ruimte



Personaliseerbaar

- 47 stoffen verkrijgbaar
- 7 kuipkleuren met optioneel zitkussen
- 4 soorten poten:
 - 4 houten poten
 - 4 poten in houtvezel
 - 4 poten in polypropyleen
 - Conferentiepot op wielen

Duurzaam

3 tinten gemaakt van 100% gerecycled materiaal

Gemakkelijk in onderhoud, afwasbaar

(kuip in polypropyleen)

Kleurenkaart

Stof

Zit*, rug* en zitkussen



Cat. A
BONDAÏ



Cat. B
STEP
STEP MÉLANGE
CHILI



Cat. C
SECRET



Cat. D
FENICE

* Behalve CAT D Secret

Polypropyleen

Zit



PB
Sneeuw wit



QW
Taupe



PM
Poederroze



PN
Turquoise

Gerecycleerd polypropyleen

Zit



OQ
Zwart



OZ
Lichtgrijs



O9
Baksteen

PRIJSLIJST P. 115

Détails en levertijden

ALLE INFORMATIE ONLINE!





Rosalie

Zooms



**Hendel voor
regelbare zithoogte**
Conferentiepot: + 13 cm
Poot op wielen: + 12,5 cm



Schrijfplateau

Productie
in Frankrijk





Ludiek & polyvalent



Kleuren- kaart

Stof
Zitkussen



Cat. A
BONDAÏ



Cat. B
STEP
STEP MÉLANGE
CHILI



Cat. C
SECRET



Cat. D
FENICE
VOGUE

Polypropyleen
Zit



PS
Wit crème



PQ
Grijs



PJ
Geel



PR
Zwart

Metaal
Poten



SQ
Verchroomd



SG
Zwart

Makkelijk te verplaatsen

In de schaal
geïntegreerde
handgreep

Campusversie

Een alles-in-een
versie met een
360° draaibaar
schrijfplateau en een
opbergplateau voor
tassen onderaan

Veelzijdig

Zowel geschikt
om te werken en
te vergaderen, als
voor opleidingen
en bedrijfs-
restaurants

Omhullende en comfortabele zit

Zitkussen als optie

PRIJSLIJST P. 116

Détails en levertijden

**ALLE INFORMATIE
ONLINE!**





Kleuren-kaart

Polypropyleen

Zit



PT
Wit



PV
Antraciet



PU
Zwart



PZ
Rood



PC
Dengroen

Metaal

4 poten



SQ
Verchroomd



SO
Wit



X1
Antraciet



SG
Zwart



ZY
Rood



SW
Dengroen

Meeting+

Licht

Makkelijk te transporteren en te stapelen
(tot 15 stuks)



Brandwerend

Schaal M2 (Optie)



Kleurrijk

5 kleuren voor de zitting op een
verchroomd onderstel of in de
kleur van de schaal



Schrijfplateau

PRIJSLIJST P. 117

Détails en levertijden

ALLE INFORMATIE
ONLINE!



Antibacterieel
oppervlak

Zonder
armleuning

Met schri-
fjplateau



Anthra+



Multifunctioneel
Met of zonder accessoires

Rug naar keuze
Stof of mesh

Stabelbaar
Tot 12 stoelen



Zonder armleuning, zonder schrijfplateau



Met armleuning, zonder schrijfplateau



Géo



Vouwbaar

Met handgreep

Polyvalent



Kleurenkaart

Stof
Zit en rug



Cat. A
BONDAÏ



Cat. B
STEP

Mesh Rug



TI Zwart

Metaal Poten



SB Grijs



SG Zwart

PRIJSLIJST P. 118

Détails en levertijden

ALLE INFORMATIE ONLINE!



Kleurenkaart

Stof
Zit en rug / Poten



FA/SG
Nachtzwart / Zwart



FG/SG
Stormgrijs / Zwart

SKAI
Zit en rug / Poten



YA/SQ
Zwart / Verchroomd

PRIJSLIJST P. 118

Détails en levertijden

ALLE INFORMATIE ONLINE!





Évasion

VOOR EEN NATUURLIJKE UITSTRALING

EVASION onderscheidt zich door een subtiel samengaan van metaal en naturel beuken, maar ook met de grafische en ranke lijnen. Een erg complete collectie met tafels en bijpassende stoelen. EVASION is leverbaar in verschillende vormen en afmetingen en is net zo goed geschikt voor bedrijfsrestaurants als vergaderruimtes.

Productie
in Frankrijk





Modern & warm



Makkelijk te verplaatsen
Geïntegreerde handgreep in de rugleuning

Afwasbaar en slijtvast
(zit van beuken multiplex met laminaat, geöliede rand)



Comfortabel
Krasvaste verzinkte voetensteun



Afwerkingsdetails
Metaaldecor van de houten poot passend bij de zit (wit of zwart)

Kleurenkaart

Beuken
Zit en decor



VKZOMS
Wit massief beuken



VMZPMS
Zwart massief beuken

Mogelijkheid om andere metaalafwerkingen te kiezen, zie algemene kleurenkaart

PRIJSLIJST P. 119

Détails en levertijden

ALLE INFORMATIE ONLINE!





Sofia

DE STOEL IN DE STIJLVAN DE FIFTIES

SOFIA staat voor een subtiel huwelijk tussen de retrostijl van de jaren '50 en de strakke lijnen van Scandinavisch meubilair. Precies die combinatie biedt veelzijdigheid qua stijl: ludiek met warme kleuren of sober en elegant met koelere kleuren.





Fifties stijl

Veelzijdig

De kruk is ideaal voor hoge tafels in projectruimtes of bedrijfsrestaurants



Ruim en comfortabel
Breedte van de zit: 44 cm

Makkelijk afwasbaar
(Polypropyleen schaal)

Kleuren- kaart

Polypropyleen Zit



PL
Perzik



PU
Zwart



QO
Marsala
rood



QW
Taupe

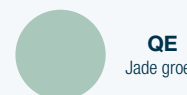

QE
Jade groen



PD
Amandel
grijs



OW
Wit

Metaal 4 poten



SQ



SG



ZE

PRIJSLIJST P. 119
Détails en levertijden

**ALLE INFORMATIE
ONLINE!**





Tara

STOEL MET SOEPEL COMFORT

Wie plaatsneemt in TARA is onmiddellijk verrast door het soepel zitcomfort van de rug. Het materiaalgebruik is minimalistisch wat de stoel opvallend licht maakt, zowel visueel als qua gewicht.





Origineel & kleurrijk



Licht

Makkelijk te verplaatsen en stapelbaar
(tot 6 stoelen)

Flexibele rug

Voor soepel comfort



Makkelijk afwasbaar

(polypropyleen schaal)



Colorblock

Poten in de kleur van de schaal

Kleuren- kaart

Polypropyleen / Metaal

Zit en onderstel



PTSO
Wit



POZ5
Granaat rood



PPZ6
Donker-
groen



PUSG
Zwart



XKZY
Rood



PIZ7
Warm grijs

PRIJSLIJST P. 120

Détails en levertijden

**ALLE INFORMATIE
ONLINE!**





Line

DE BISTROSTOEL REVISITED

Een knipoogje naar de caféstoel van de jaren '20, maar LINE overtreft zijn houten voorgangers ruimschoots in techniciteit. Vervaardigd uit één geheel van polypropyleen. LINE is bestand tegen weer en wind. Indoor of outdoor, praktisch en comfortabel, een vintage stijl in een technisch jasje.





Retro & outdoor



Licht

Makkelijk te verplaatsen en te stapelen (tot 10 stoelen)

Colorblock

Poten in de kleur van de schaal



Afwasbaar en praktisch

De versie met armleuningen kan worden opgehangen aan een tafel om het schoonmaken van de vloer te vergemakkelijken



Indoor en outdoor

Anti-UV behandeld

Kleurenkaart

Polypropyleen
Zit en poten



PT
Wit



PO
Grijsrood



PP
Donkergroen



PU
Zwart



QF
Zand



QG
Bruin



PI
Warm grijs

PRIJSLIJST P. 120

Détails en levertijden

**ALLE INFORMATIE
ONLINE!**





Gelati

RESOLUUT EIGENTIJD

GELATI is een resoluut eigentijdse stoel die past in elke omgeving.

De lichte zitschaal is behandeld tegen UV-straling en is geschikt voor zowel binnen als buiten. Leverbaar in versie met 4 poten of kruk. Ideaal voor zowel bedrijfsrestaurants als projecttafels in de werkomgeving.





Indoor & outdoor



Veelzijdig

De kruk is ideaal voor hoge tafels in projectruimtes of bedrijfsrestaurants

Indoor et outdoor

Behandeld tegen UV-straling en corrosie (alleen wit en zwart onderstel)



Personaliseerbaar

3 pootkleuren: verchromd, zwart of wit



Afwasbaar

(polypropyleen schaal)

Kleuren-kaart

Polypropyleen

Zit



PT
Wit



QA
Grijs



PU
Zwart



PV
Hemels-
blauw



QH
Bosgroen



XK
Rood

Metaal

Poten



SQ
Verchromd

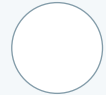

SO
Wit



SG
Zwart

PRIJSLIJST P. 120

Détails en levertijden

**ALLE INFORMATIE
ONLINE!**





Spoon

+ Hout en kleur hand in hand



Afwasbaar en slijtvast
Bekleed met laminaat

Eén kleur of tweekleurig
Wit/rood of blauw/wit

Comfortabel
Krasbestendige verzinkte
voetensteun

Kruk met gaslift
(+ 26 cm)

Kleurenkaart

Lamin Zit



VK
Wit



RN
Wit / Rood



RI
Eiken

Metaal Onderstel



SQ
Verchroomd

PRIJSLIJST P. 120

Détails en levertijden

**ALLE INFORMATIE
ONLINE!**





Tic

+ Ideaal voor bedrijfsrestaurants



.....

Afwasbaar en slijtvast

Gevernist beuken

.....

Makkelijk te verplaatsen

Handgreep geïntegreerd
in de rug

Kleurenkaart

Beuken

Zit



WP

Metaal

Poten



Grijs alu

PRIJSLIJST P. 120

Détails en levertijden

ALLE INFORMATIE
ONLINE!



Stoelen



Omgekeerd
sledeonderstel



2
JAAR





Accessoires





Accessoires



Verlichting

Pagina 266 >

.....



Kunstplanten

Pagina 268 >

.....



Sorteren

Pagina 270 >

.....



Kapstokken & kledingrek

Pagina 272 >

.....



Schrijfbord & mededelingenbord

Pagina 273 >

.....



Schermhouders

Pagina 274 ›

.....



Computer- meubilair

Pagina 277 ›

.....



Bureau- accessoires

Pagina 277 ›

.....



Connectiek

Pagina 278 ›

.....



Lampen



OL05 – 810 lumen
3 scharnierpunten



DL05 - 806 lumen
Linnen lampenkap
of met houtdecor
Ingekleurde houten poten



OL08 – 810 lumen
2 scharnierpunten



OL02 – 650 lumen
5 lichtsterktes
3 kleurtemperaturen
USB-poort + inductielader



DL08 - 2 x 806 lumen
Retro look
Gelakt metaal



OL07 - 510 lumen
3 lichtsterktes
3 kleurtemperaturen
Flexibele arm



Staande lampen



- FL09 – 9059 Lumen
- Directe / indirecte verlichting
 - Met of zonder aanwezigheidssensor

- CL05 – 1100 lumen
- lampenkap met houtdecor of wit linnen
 - Ingekleurde houten poten



- FL02 - 2100 lumen
- Regelbare lichtsterkte
 - Gelakt metaal

- CL09 – 1100 lumen
- Chinz lampenkap
 - Staand en geïntegreerd tafeltje van gelakt metaal



Andere kleuren leverbaar, zie prijslijst

PRIJSLIJST P. 124
Details en levertijden

ALLE INFORMATIE
ONLINE!





Decoratieve kunstplanten in potten



Onion grass
H. 90 tot 180 cm



Bonsai Ficus
H. 149 tot 180 cm



Bamboe
H. 160 tot 200 cm



Veldgras
H. 125 cm

Complete sets
Inclusief pot, plant en grind

Natuurlijk hout
Kunststof bladeren

Glanzend gelakt afwerking
Voor de ronde potten

Matte afwerking
Voor de vierkante potten

Kleurenkaart

Gelakt
Ronde potten



O7
Wit



O5
Taupe



O8
Zwart

Mat
Vierkante potten



OG
Wit



O6
Taupe



OK
Antraciet



Decoratieve kunstplanten in bakken



^
Papyrus
H. 127 cm



^
Bamboe
H. 197 cm



^
Onion grass
H. 70 tot 200 cm



Ruimte-indeling
Verkrijgbaar in verschillende
hoogtes

3 plantensoorten
Papyrus, onion grass of
bamboe

Afwerking
Decoratief grind van
kwarts of kalksteen

Licht & kwalitatief
Bak van fiberstone,
licht materiaal

Kleurenkaart

Fiberstone



OG
Wit



OF
Zwart



**Samen voor het milieu: voor elke
gekochte bak wordt een boom
aangeplant**

Productie
in Frankrijk



PRIJSLIJST P. 126
Détails en levertijden

**ALLE INFORMATIE
ONLINE!**





Sorteren

Individuele prullenbak



Prullenbak 26 L.

Geschikt voor A4 documenten. Uit 100% gerecycled materiaal (alleen kleur zwart)

[o] Opties



◀ **Bak 5 L.**
Voor organisch afval



◀ **Bak 9 L.**
Voor plastics



◀ **Deksels**
Voor bakken 5 en 9 L.

Productie
in Frankrijk





Collectieve vuilnisbakken

+ Dynamisch & modulair



Inhoud 60 L.

Met uitneembare kunststofbak (meegeleverd)

Gekleurde pictogrammen

Om de type afval aan te duiden

Mobiel

Makkelijk verrijdbaar

Robuust

Plaatstaal, dikte 10/10

Opties



**Verbindings-
platen**



Deksel
(aanbevolen voor de organische afval)



Achterdeur

Productie
in Frankrijk



PRIJSLIJST P. 127
Détails en levertijden
**ALLE INFORMATIE
ONLINE!**





Kapstokken

30%
%



Wotan

- 8 kledinghaken,
- 4 tashaken
- 4 paraplueringen



Basty

- 8 kledinghaken,
- 4 tashaken
- 4 paraplueringen



Flora

- 7 kledinghaken
- Ring voor 4 paraplu's



Aloès

- 6 langwerpige kledinghaken
- 2 parapluhouders

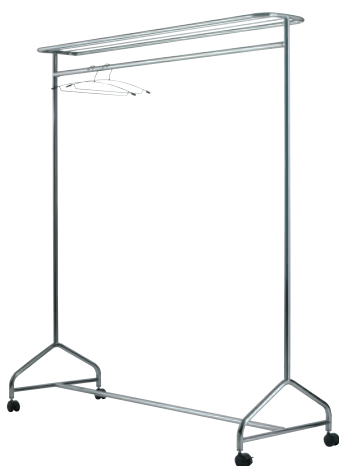

Verrijdbaar kledingrek



Met hoedenrek, geschikt voor 40 jassen



Magnetische kledinghaken

29%
%



Te bevestigen op metalen ondergrond. Draagvermogen 9 tot 11 kg



Kleurenkaart

Wotan



Zwart

Basty



Verchromd

Flora



Wit



Zwart

Aloès



Alugrijs

PRIJSLIJST P. 128

Details en levertijden

ALLE INFORMATIE
ONLINE!



Schrijfborden

09 %

Verticaal of horizontaal te bevestigen (schroeven meegeleverd)



Aluminium frame

- Gelakt - 90 x 120 cm
- Geëmailleerd 60 x 90 cm,
- Magnetisch oppervlak en droog uitwisbaar



Zonder frame

- Gelakt - : 75 x 115 cm
- Magnetisch oppervlak en droog uitwisbaar



Verrijdbare flipover

- H. 186 cm
- Magnetisch oppervlak van gelakte metaal



Accessoireset

- Markers + magneten + magnetische veger + reinigingsmiddel

14 %

Medede- lingenbord

Verticaal of horizontaal te bevestigen (schroeven meegeleverd).



Mededelingenbord

- Natuurlijke kurk, dikte 12 mm
- 60 x 90 cm – 90 x 120 cm

PRIJSLIJST P. 74

Details en levertijden

ALLE INFORMATIE ONLINE!



14 %

Bureau-accessoires

56 %



Hangende lade

Metaal
Bevestigd onder het blad



Voetensteun

Naargelang model, hoogte verstelbaar:
In 2 posities en 6 hellingshoeken
4 posities en 4 hellingshoeken



Metaal prullenmand

Inhoud 20L

PRIJSLIJST P. 130

Details en levertijden

ALLE INFORMATIE ONLINE!





Schermhouders

Met regelsysteem om de hoogte perfect in te stellen en rug- en nekklachten te voorkomen

Bevestigd op het blad

Voordelen: bevestiging op een willekeurige plaats.
In een uitsparing, door een kabeldoorgang of gewoon met een klem op het blad

Bevestigd op een rail

Een plaatsbesparende oplossing waarmee niets van het werkoppervlak wordt ingenomen. Te bevestigen op een privacy-paneel Lucien



Al onze schermhouders voldoen aan de norm VESA 75 of 100 mm



Bevestigd op het blad

Een evolutief systeem, voor 1 of 2 schermen!

1. Kies de lengte van de arm



Lengte 28 cm - Enkele arm.
Een of twee houders.



Bereik van 43 cm - Dubbele arm
Een of twee houders

2. Kies de bevestiging



Bevestiging 3 in 1

- Voor bladdikte 10 tot 50 mm
- Op klem D. 25 mm
- Op staander via de kabeldoorgang of door het blad



Op klem D. 65 mm

- Voor bladdikte 13 tot 25 mm
- Geschikt voor privacy-panelen SOLANGE



Klemmen voor 1
of 2 schermen

Van 1 naar 2 schermen overschakelen?

Bestel dan een bevestigingsklem voor 2 houders en 1 extra arm!

Technische kenmerken

- Aluminium houder met luchtveren, enkele of dubbele arm (draagwijdte 28,3 cm of 43,3 cm).
- Geïntegreerde kabelgeleiding
- 360° draaibaar
- Schermformaat: tot 27 inch. Max. draagvermogen: 7 kg



Schermhouders

Bevestigd op het blad

Economy

- 4 scharnierpunten op klem.
- Voor 1 of 2 schermen
- Schermformaat: 10 tot 32 inch
- Max. draagvermogen: 8 kg
- Met klem aan het blad bevestigd of in de plaats van de kabeldop (door het blad bevestigd)



1 scherm



2 schermen

Standaard

- 4 scharnierpunten met gasveer
- Voor 1 of 2 schermen
- Schermformaat: 17 tot 32 inch
- Max. draagvermogen: 9 kg
- Met klem aan het blad bevestigd of in de plaats van de kabeldop (door het blad bevestigd)



Bevestigd op rail

Economy



1 scherm

- Max. draagvermogen: 8 kg, B.13 cm
- 2 scharnierpunten



1 schermen

- Max. draagvermogen: 6 kg, B. 24,5 cm
- 3 scharnierpunten

PRIJSLIJST P. 131

Details en levertijden

ALLE INFORMATIE
ONLINE!





Toetsenbordhouder



Antraciet ABS

Bevestigd onder het blad – Geïntegreerde pennenhouder.

In hoogte verstelbaar van 2 tot 5 cm

CPU-houders



Houder met metalen arm

- Afwerking wit, alugrijs of zwart
- Aanbevolen voor bureaus AXEL & LUTZ 2



Houder met metalen arm

Afwerking alugrijs



Houder met verstelbare beugels

Afwerking alugrijs

Computertafels



Verrijdbare bijzettafel

- Wit melamine blad, dikte 25 mm
- Alugrijze metalen structuur



Verrijdbaar computermeubel

- Melamine blad, beuken afwerking, dikte 19 mm
- Lichtgrijze metalen structuur
- Voorzien van 4 wielen, waarvan 2 met rem



PRIJSLIJST P. 132

Details en levertijden

ALLE INFORMATIE ONLINE!



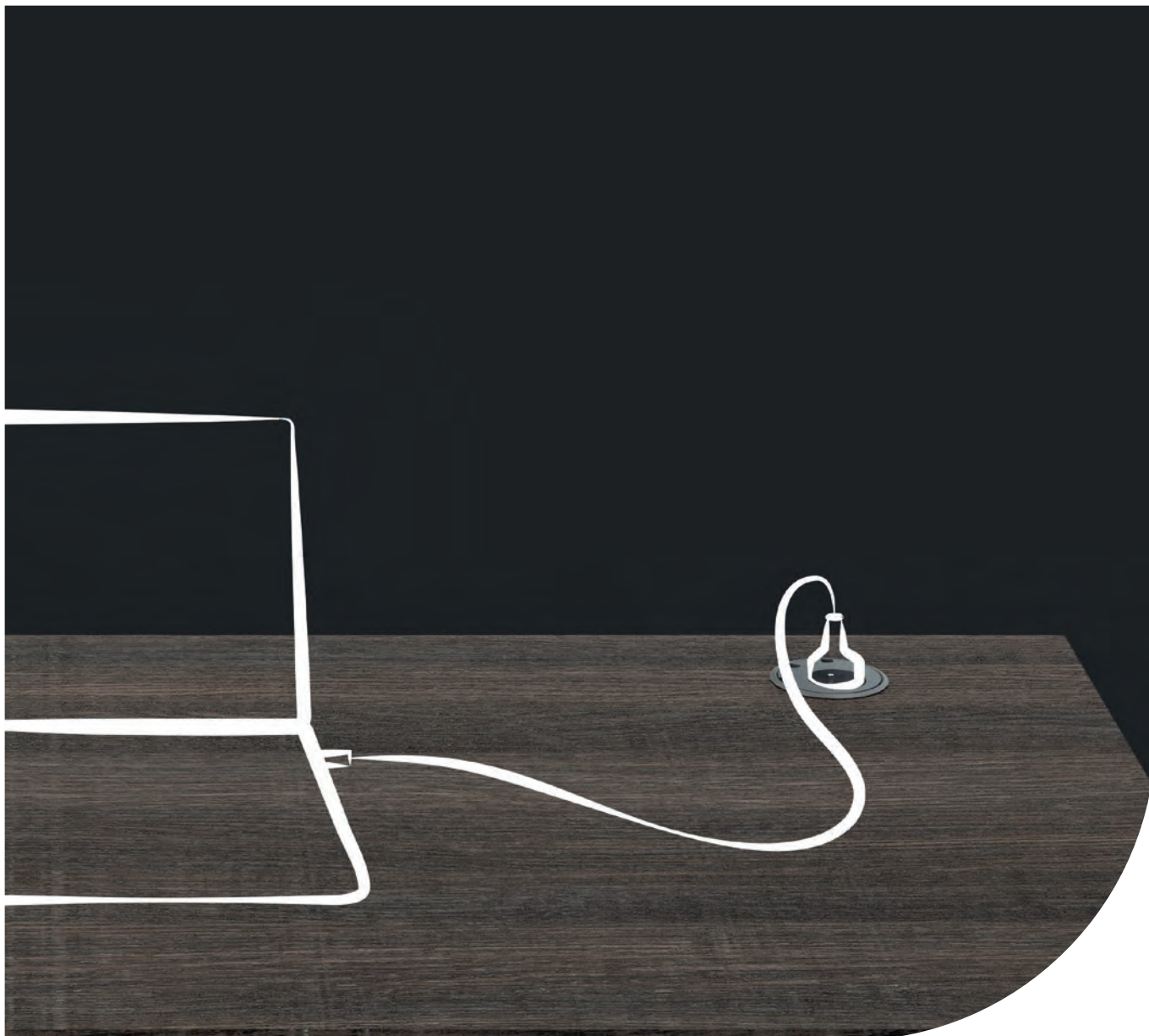

CONNECTIEK

Welke aansluitmogelijkheden voor mijn bureau?

Doordachte aansluitmogelijkheden dragen bij tot het welzijn van de medewerkers! Ze moeten vlot en discreet toegankelijk zijn en mogen geen werkoppervlak innemen. Om smartphones, tablets of PC's aan te sluiten, de oplossingen zijn zeer divers.



PRIJSLIJST P. 133

Details en levertijden

AL ONZE CONNECTIEK-
OPLOSSINGEN





Voor flexplekken

Rechtstreekse aansluitpunten: praktisch en tijdbesparend



Kabeldoppen met connectiek

- Met of zonder schuifdeksel
- Naargelang het model, stopcontact, USBA of C poort, RJ45 of HDMI



Willekeurige aansluitpunten

- Multikubus, los te plaatsen
- Design aansluitbox, los te plaatsen of te bevestigen
- Stekkerdoos, te bevestigen

Voor medewerkers met vast bureau of voor premium werkomgevingen

Kiezen voor comfort en esthetiek met een technisch luik: de aansluitpunten zijn rechtstreeks toegankelijk, maar netjes aan het zicht onttrokken

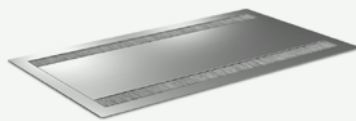

Soft-closing luiken

- Enkelzijdig
- Of dubbelzijdig toegankelijk



Met of zonder connectiek

Met stopcontact, USBA of C poort, RJ45 of HDMI

Budgetvriendelijke oplossingen

Kies voor een kabeldop of een stekkerdoos die gewoon in de kabelgoot wordt geplaatst. Toegankelijk onder een schuivend blad, een blad met uitsparing of via een luik zonder connectiek

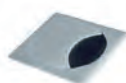

Kabeldoppen



Stekkerdoos

Met stopcontact, USBA of C poort, RJ45 of HDMI



Voedingskabels

2 of 3 meter



Kabelgeleiding

Kabels netjes georganiseerd

In een werkomgeving waar kabels netjes zijn weggewerkt en georganiseerd, kunnen mensen zich beter concentreren. Enkele of dubbele kabelgoten, magnetische of vastgeklikte verticale kabelgoten of kabelkokers, er is altijd een geschikte oplossing!

PRIJSLIJST P. 135

Details en levertijden

AL ONZE CONNECTIEK-
OPLOSSINGEN





Kabelgeleiden onder het blad

Met een kabelgoot of kabelhaken voor vrijstaande of gedeelde bureaus

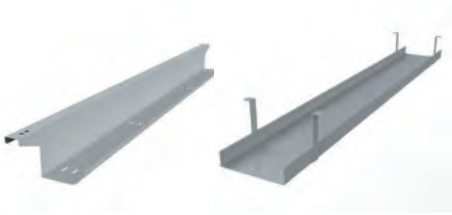

Metalen kabelgoten
Enkel of dubbel



kabelgoot



Kabelhaken
(Set van 2)

Kabelgeleiden naar de vloer

Naar keuze: een magnetische of aan de poot vastgeklikte kabelgoot of flexibele oplossingen zoals een uittrekbare kabelkoker of een kabelhuls



Metalen kabelgoten
• Vastgeklikt
• Of magnetisch



Uittrekbare kabelkokers
Voor vaste of in hoogte regelbare bureaus



Kabelhuls met rits
Verkrijgbaar in 3 lengtes

Frontpaneel in verschillende uitvoeringen

Om privacy te creëren onder een vrijstaand bureau en een afgewerkt accent toe te voegen in open kantoorruimtes



Metalen frontpaneel



Stoffen frontpaneel
• Opklapbaar
• Metalen verstevigingsplaat



Melamine frontpanelen,
dikte 19mm

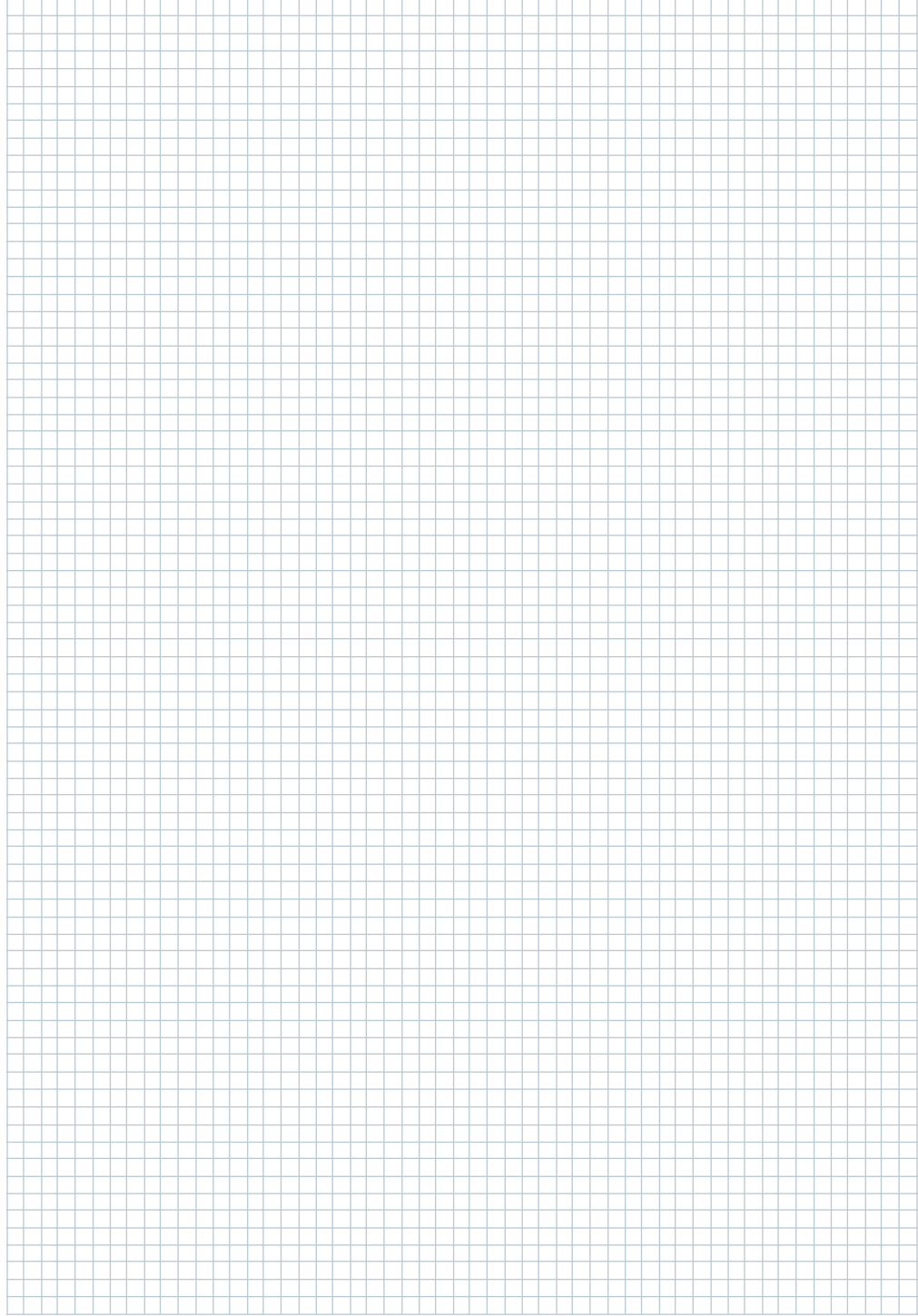



Kleurenkaart

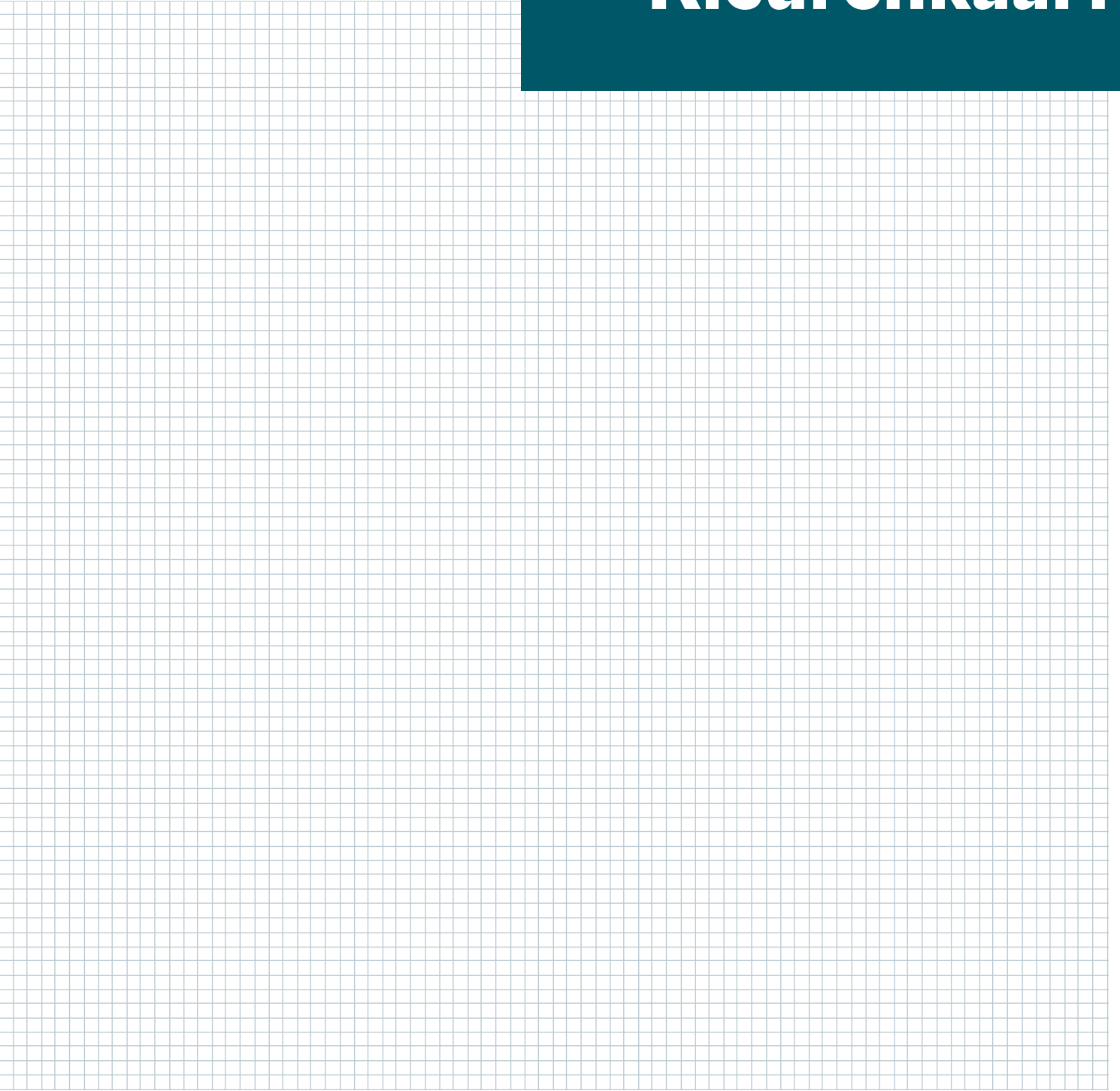



Melamine houtdecor



MA
Wit esdoorn



R2
Honfleur beuken



RI
Licht eiken



RZ
Lakeland acacia



R3
Brunswick eiken



N8*
Zeedennen

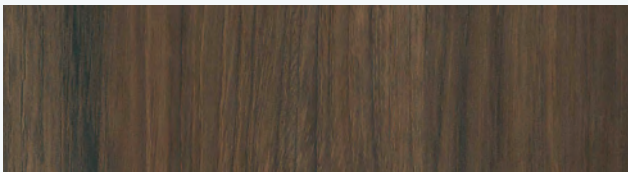

N6
Bruin notelaar

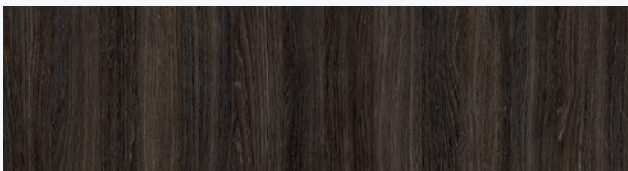

M9
Koffie eiken

Melamine effe kleuren

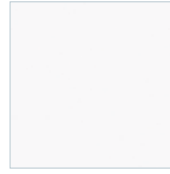

MG
Sneeuw wit

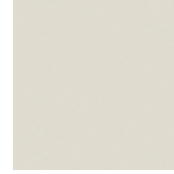

M5
Nevelgrijs



N7
Parelgrijs

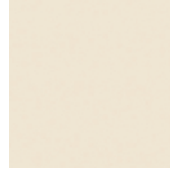

N5
Linnen



M7
Fjord groen



N9
Zwart

Melamine soft touch



MK
Fluweelzwart



Fluweelzacht
gevoel



Mat
effect

Laminaat

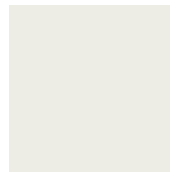

HZ
Wit



VW
Zwart

*N8 Zeedennen : specifieke Multi kantenbord

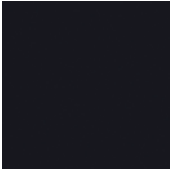
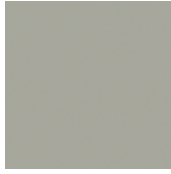
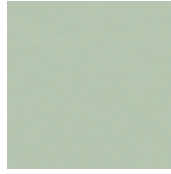
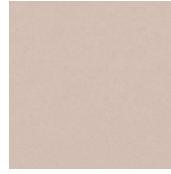
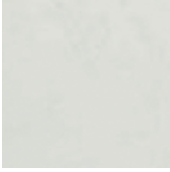
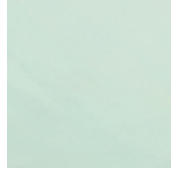
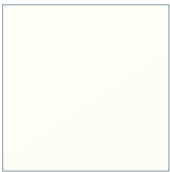
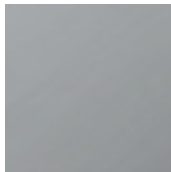
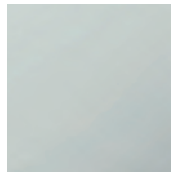
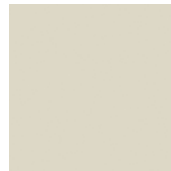
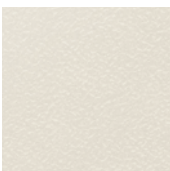
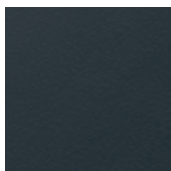
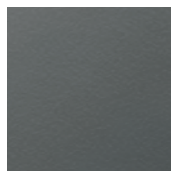
**Linoleum****LU**
Leigrijs**L4**
Taupe grijs**L2**
Pistache groen**L1**
Poeder roze**Altuglas®****OA**
Satijnwit**Glas****GS**
Glanzend wit gelakt**Glad metaal****SO**
Wit**SA/SB*/Z4****
Alugrijs**SD**
Lichtgrijs**SG**
Zwart**X1**
Antraciet**X2**
Platinagrijs**X4**
Kobalt blauw**X8**
Bleek groen**SH**
Terracotta**ST**
Engels groen**ZC**
Parelmoerwit**Z3**
Messing**Gestructureerd metaal****ZO**
Wit**SC**
Antraciet**SU**
Muisgrijs**ZP**
Zwart

*SB : specifiek voor opbergruimte

**Z4 : specifiek voor AXEL en LUTZ 2



Bondaï (Cat. A)

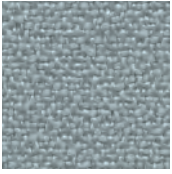

KD
Nevel grijs

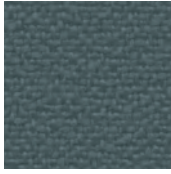

KA
Storm grijs



KE
Zwart

Chili (Cat. B)

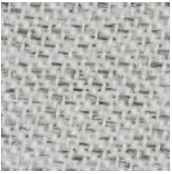

BC
Gespikkeld lichtgrijs



BD
Zwart

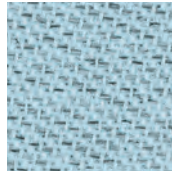

BF
Gespikkeld ijsblauw

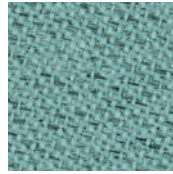

BG
Gespikkeld celadon

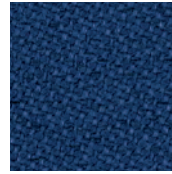

BH
Gespikkeld middernachtblauw

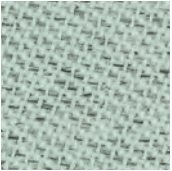

BJ
Gespikkeld opaal

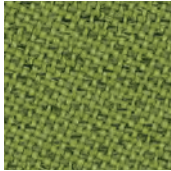

BK
Gespikkeld olijfgroen

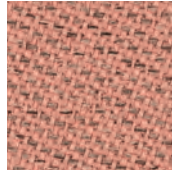

BL
Gespikkeld zalmroze

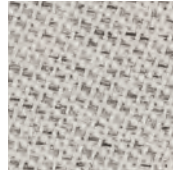

BM
Gespikkeld beige

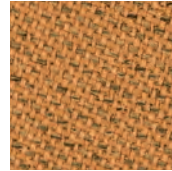

BO
Gespikkeld kurkuma

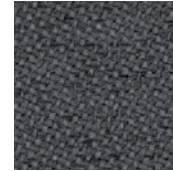

BN
Gespikkeld chocolade

Step/Step Mélange (Cat. B)

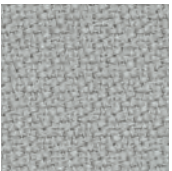

E5
Lichtgrijs



A6
Zwart

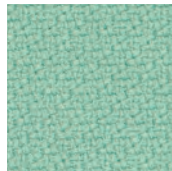

E4
Watergroen

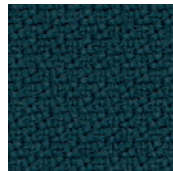

A4
Petroleum blauw

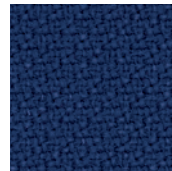

A3
Marine blauw

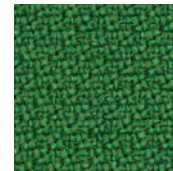

A1
Bamboe

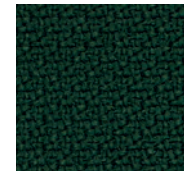

A9
Engels groen

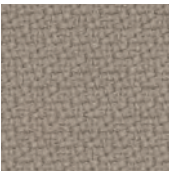

A2
Beige

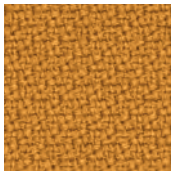

A5
Mosterd geel



E6
Terracotta

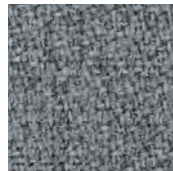

B5
Gespikkeld lichtgrijs



B1
Gespikkeld antraciet



E7
Gespikkeld watergroen



B4
Gespikkeld denim blauw



B6
Gespikkeld marineblauw

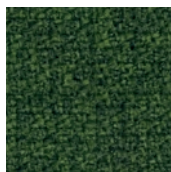

B2
Gespikkeld bamboe



E8
Gespikkeld olijfgroen

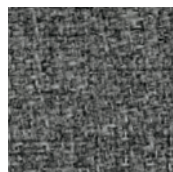

B3
Gespikkeld beige



E9
Gespikkeld mostergeel

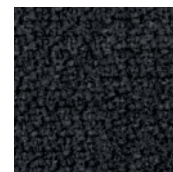

B7
Gespikkeld donkerbruin

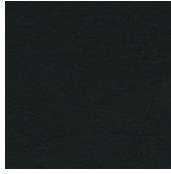
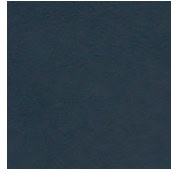
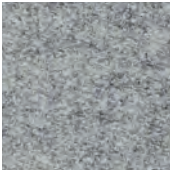
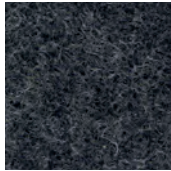
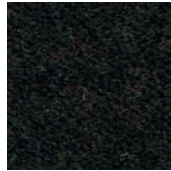
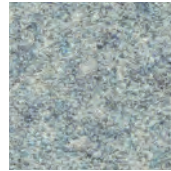
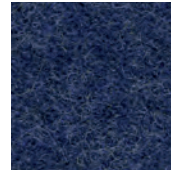
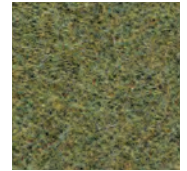
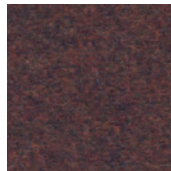
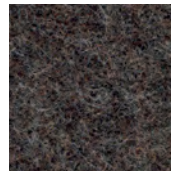
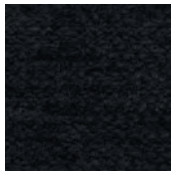
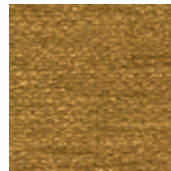
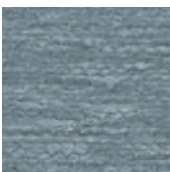
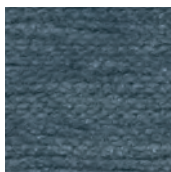
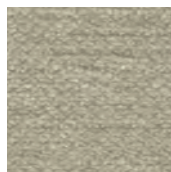
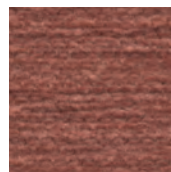
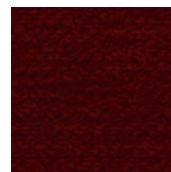
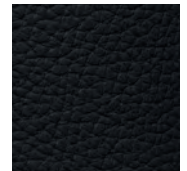
**Secret (Cat. C)****CA**
Parelgrijs**CB**
Zwart**CC**
Mineraal blauw**CD**
Hazelnoot**CE**
Olijfgroen**CF**
Donkerkopergroen**CG**
Leem**CH**
Taupe**CI**
Granaat**Fenice (Cat. D)****DA**
Gespikkeld
lichtgrijs**DB**
Gespikkeld
antraciet**CQ**
Zwart**CJ**
Gespikkeld
lichtblauw**DC**
Gespikkeld
donkerblauw**DF**
Gespikkeld
celadon**DE**
Gespikkeld
olijfgroen**DG**
Gespikkeld
donkergroen**DH**
Poeder roze**DZ**
Gebrande sienna**DD**
Gespikkeld
chocolade**DI**
Gespikkeld
kurkuma**DJ**
Gespikkeld
roestbruin**Vogue (Cat. D)****LA**
Lichtgrijs**LB**
Zwart**LC**
Olijfgroen**LD**
Mosterd geel**LE**
Horizon blauw**LF**
Rookblauw**LG**
Beige**LH**
Oud roze**LI**
Bordeaux**Leder (Cat. E)****YB**
ZwartLIJST MET DE KLEU-
RAFWERKINGENDE AFWERKINGEN GEDE-
TAILLEERD PER GAMMA
OP P.142 VAN DE PRIJSLIJST



Technische kenmerken

Melamine Laminaat Linoleum	Melamine					Laminaat	Linoleum
	Dikte 19 mm		Dikte 25 mm	Dikte 30 mm	Dikte 38 mm	Dikte 23.6 mm	Dikte 20.6 mm
	Bladen	Deuren/ombouw/ bekleding	Bladen	Bladen	Bladen	Bladen	Bladen
Tweezijdig bekleed, behandeld tegen weerkaatsing	✓	✓	✓	✓	✓	✓	Antistatische eigenschap
Afwerkingen	MG - RI	Alle	Alle	MG - RI	MG - RI - N6 - M9	HZ - VW	LU - L1 - L2 - L4
Afwerking zwart MK Mat effect, goed bestand tegen vingerafdrukken, 3 hoogwaardige laklagen	-	-	✓	-	-	-	-
Vlakke ABS stootranden, schokbestendig en afgeronde hoeken ⁽¹⁾	✓	✓	✓	✓	✓	✓	Multiplex stootrand
Antibacterieel (uitgezonderd kleur Fluweelzwart MK)	✓	✓	✓	✓	✓	✓ Sanitized® behandeling	✓
Dichtheid ⁽²⁾	620 > 690 kg/m ³		600 > 670 kg/m ³	640 kg/m ³	630 kg/m ³	650 kg/m ³	750 kg/m ³
PEFC (grondstoffen uit duurzaam beheerde bossen)	✓	✓	✓	✓	✓	✓	✓
E05 / E1 gecertificeerd (voldoet aan norm NF EN 717)	E05					E1	E1
Brandklasse (voldoet aan norm NF EN 13501-1)	Klasse M3 (D-S2, d0 EUROCLASS) voor alle decors / M2 voor kleur wit MG						
Gemiddeld % uit gerecycleerde materialen (voor- en na-consumptie)	68%. Kleuren R3, M9, N9, MK, N7, N8 zijn CRADLE to CRADLE gecertificeerd					40%	28%
% recycleerbaar	100%					100%	28%
Onderhoud	Reinigen met vochtige doek en sopje (zacht pluisvrij voor linoleum en zwart MK). Vermijd schurende producten en detergenten.						

(1) Stootranden in de kleur van het blad, met uitzondering van kleur N8 (specifieke multiplex stootranden).

ABS stootranden, dikte 2 mm (voornamelijk) en 1 mm rechtere rand

(2) Dichtheid: tolerantie +/- 10% stootrand ABS 2 mm



Technische kenmerken

Stof	Samenstelling	Stofgewicht	Slijtweerstand	Lichtvastheid	Schuurweerstand	Brandveiligheidsnormen	Milieulabel
Bondai Cat. A	100% polyester	350 g/ml (lm) 250 g/m ² ±5%	150 000 EN ISO 12947-2	6 EN ISO 105-B02	4-5 EN ISO 105 x 12 Nat-Droog	EN 1021 - 1&2 BS 7176 BS 5852 Crib5	STANDARD 100 by OEKO-TEX®
Chili Cat. B	100% post-consumer gerecycleerd polyester fr (fr in de vezel)	470 g/ml (lm) (15.16 oz / lin yd)	60 000 EN ISO 12947-2	5-8 EN ISO 105-B02	4-5 EN ISO 105 x 12 Nat-Droog	EN 1021 - 1&2 NFP 92-503/504/505 M1 NF D 60-013 AM18 BS 7176 BS 5852 Crib 5 DIN 4102 B1 EN 13501	STANDARD 100 by OEKO-TEX® 100% gerecycleerde vezel Lage VOS-emissie
Step Step Melange Cat. B	100% trevira® CS	470 g/m ² (15.16 oz / lin yd)	100 000 EN ISO 12947-2	5-7 EN ISO 105-B02	4-5 EN ISO 105 x 12 Nat-Droog	EN 1021 - 1&2 NFP 92-503/504/505 M1 NF D 60-013 AM18 BS 7176 BS 5852 Crib 5 DIN 4102 B1 EN 13501	STANDARD 100 by OEKO-TEX® EU Ecolabel Niet-metaalhoudende verfstoffen Lage VOS-emissie
Secret Cat. C	76% PVC - 22% PES - 2% PU Efficiënt tegen bacteriën	540 g/ml (lm) ±10 g/m ²	60 000 EN ISO 5470-2	6-7 EN ISO 105-B02	5-5 EN ISO 105 x 12 Nat-Droog	EN 1021 - 1&2 BS 5852 1&2 UNI 9175 class 1IM TB 117:2013	Flataatvrij
Fenice Cat. D	75% wol 25% PA	335 g/m ² ±7% 500 g/ml (lm) ±7%	100 000 ±20% EN ISO 5470-2	6 ±1% EN ISO 105-B02	4-5 EN ISO 105 x 12 Nat-Droog	EN 1021 - 1&2 BS 5852 Crib 5 CLASS 1 IM CALIFORNIA TB 117	Recycleerbare stof
Vogue Cat. D	100% polyester trevira CS	700 g/ml (lm) 500 g/m ²	200 000 EN ISO 12947-2	6 EN ISO 105-B02	4-5 EN ISO 105 x 12 Nat-Droog	EN 1021 - 1&2 NFP 92-501-7 M1 NF D 60-013 AM18 BS 7176 BS 5852 Crib 5 DIN 4102 B1 CA UNI 9174 UNI 8456 CALIFORNIA TB 117 IMO for upholstery Part 8	STANDARD 100 by OEKO-TEX®

Index



A	Accessoires (bureaublad)	273	LUCIE	202	
	Accessoires (vergaderen)	273	LUCIEN	123	
	Accessoires (op te hangen)	121 - 123 - 129	Luiken	279	
	ALTER	222	LUTZ 2	92	
	ANTHRA	249			
	ARIAL bureaus	106	M	MANHATTAN	213
	ARIAL vergadertafels	168		MARGOT	28
	ARIV	144		MARTIN	180
	ARMAND	140		MEETING+	248
	ATTITUD	211		Melamine ladeblokken	130 - 133
	AXEL 2	86		Melamine ladeblokken eco	133
B	Banken	153 - 196		MELINA	130
	BIP	34		Metalen ladeblokken	134
	Buisrekken	150 - 151		MIA	223
	Bureaus op wielen	92 - 106		MODULO	164
C	CAMILLE	136		MOKA	70
	CHATBOX	184	N	NAVERT	146
	CHEST	39	O	Ontvangstbalies	42-48
	CLARA	201		OPUS	215
	COACH ergo	214		Opzetmodules	133
	Collectieopbergruimt	136 - 140 - 152 - 272		Ordnrs	149
	Computertafels	277		OSCAR	220
	CONNECT	100		Outdoor tafels	202 - 203
	CPU-houders	277	P	PING	178
D	Demonteerbare kasten	148		Polyurethaanstoelen	227
E	ELIOTT	216		Polyvalente tafels	190
	ELOISE	194		privacy-panelen	116 - 122 - 123
	ELTON	212 - 234		Prullenbak	135 - 270 - 273
	E-MEETING	176	R	RIO	74
	EMI (stoelen)	240		ROBIN bureaus	96
	EMI (tafels)	192		ROBIN directiebureaus	78
	EVASION (stoelen)	250		ROBIN vergadertafels	174
	EVASION (tafels)	198		Roldeurkasten	144-146
	EVASION (zitbalken)	54		ROMY	236
F	Flatscreenhouders	274		ROSALIE (stoelen)	246
	Flipover	273		ROSALIE (zitbalken)	55
	FORSTYL	114	S	Scheidingswanden	116 - 122
	Frontpaneel	281		Schrijfborden	180 - 273
G	GALWAY	38		SCOTT	244
	GELATI	258		SEVEN	210
	GEO	249		SOFIA	252
	GLOBE XXL	226		SOLANGE	116
	GRETA	48		Sorteerafvalbakken	270
	GUEST	42		SOSIE zitbalken	55
	GUSTAVE	128		SPOON	260
H	HARLY	213		Staaende lampen	267
	Home office	82 - 92 - 220 - 234		Stekkerdozen	279
	HOMERE	82		Stoelen 24H Pro	226
I	IDOL	110	T	Tafels met vrije beenruimte	191
	INVENTIV	232		TARA	254
	IRIS	203		Tekenaarsstoelen	216 - 220 - 227
	ISABEL	230		TIC	261
J	JAMES	126		Toetsenbordhouder	277
K	Kabeldoppen	278		TOM	224
	Kabelgeleiding	280		TOWERS	128
	Kabelgoten	281		TWINS	122
	Kapstokken en kledinghaken	272	U	Universele krukken	227
	KARA	64	V	Voedingskabels	279
	KARL	60- 158		Voetensteun	273
	Klaptafels	188 - 192		Vouwtafels	193
	Krukken	246 - 250 - 252 - 254 - 258 - 260 -261	Z	ZELIE	22
	Kunstplanten	268		Zitbalken	54-55
L	Lage tafels	40		Zitbanken	22 - 28 - 38 - 39 - 184
	Lampen	266			
	LEON	218			
	LINE	256			





Kantoormeubelen uit voorraad
Snelle levering en montage
eol-group.net