

Camille 2

THE MODULAR, SECURE STORAGE LOCKERS



EUROPEAN
OFFICE
FURNITURE
MANUFACTURER



Camille 2

The modular, secure locker unit

CAMILLE 2 is a comprehensive range of modular lockers designed to meet personal and shared storage needs in workspaces.

Available in 4 to 12 compartment modules, it adapts to every office use: reception areas, open-plan offices, collaborative zones, training spaces and more. Its three locking systems - standard key, combination lock or RFID - keep personal belongings secure according to each user's needs.

CAMILLE 2 offers a wide range of configuration possibilities, with quarter-circle open modules, intermediary wardrobe coat rail, independent bench and an acoustic PET-upholstered back version. Practical, elegant and modular, it makes life easier for your employees and visitors.

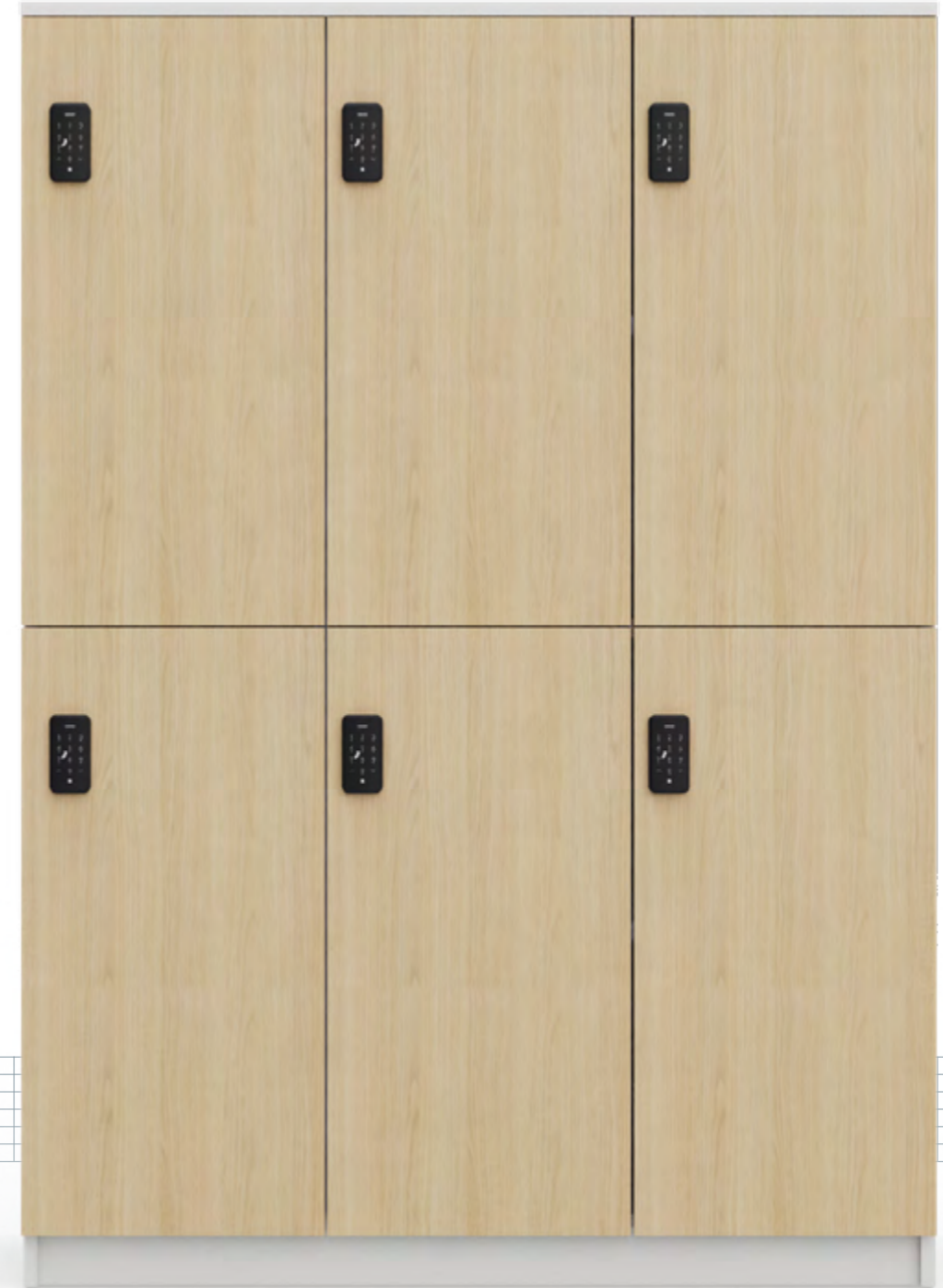

Camille 2

Designed by EOL Design Studio

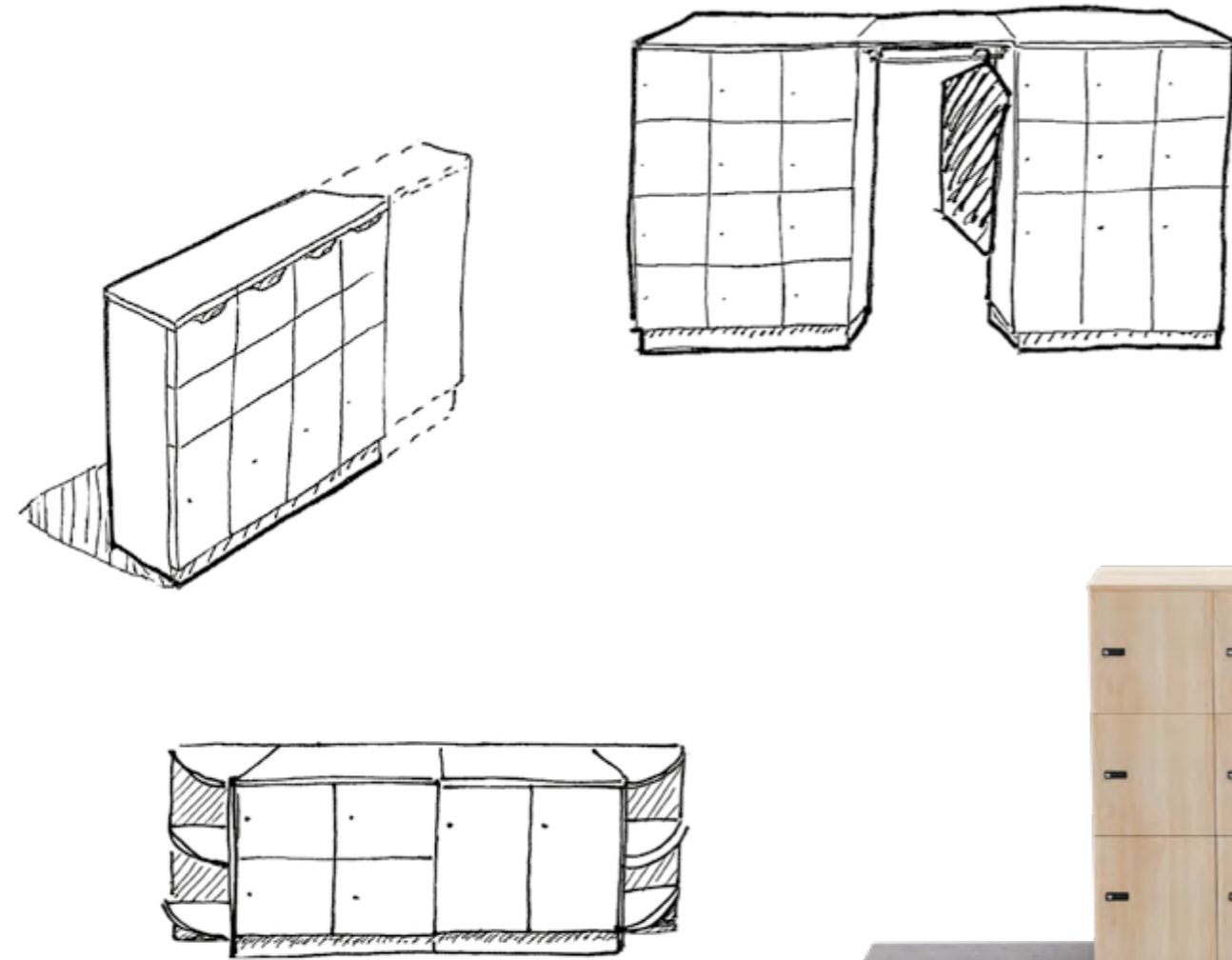

« The challenge in developing our CAMILLE 2 locker range was to find the right balance between a simple, cohesive aesthetic, harmonious proportions and the optimisation of raw-material offcuts.

This approach is built around a modular design, making it possible to configure layouts suited to both intended uses and planning constraints.”

Pauline Codron
EOL Art Director



Inspired by the history and values of French design, the Design Studio is a team of experts made up of an art director, product designers and interior architects.

Their role?

- › Carry out active trend monitoring to create a space that reflects your identity.
- › Imagine, design and create EOL products.
- › Advise you on your space-planning project: listening, analysis and 2D or 3D plan creation.

Have a project in mind? Contact us!



SECURE STORAGE FOR RECEPTION AREAS

In reception areas, CAMILLE 2 provides visitors and employees with accessible, secure storage from the moment they arrive. It makes it easy to put away personal belongings while keeping the space organised. Available in 4 to 12 compartments modules, it can be fitted with doors offering a choice of locking systems: standard key lock, combination or RFID. Combined with a wardrobe coat rail or a cushioned bench, it creates a reception point that is functional, comfortable and naturally integrated into the workplace.

^
CAMILLE 2 lockers
MARGOT seat
ZELIE low table



THE LOCKER THAT FITS INTO SHARED SPACES

Modular, secure and elegant, CAMILLE 2 offers a simple, effective solution for shared spaces. In the acoustic PET-upholstered back version, it creates both visual and acoustic separation between work zones, without the need for partitioning. The lockers adapt perfectly to collaborative spaces, open-plan offices and reception areas, keeping belongings accessible, secure and neatly stored throughout the day.

▲
CAMILLE 2 lockers
MARGOT low table
MARGOT armchairs and sofa
AXEL 2 desks
OSCAR 2 office chairs
ALOCASIA decorative plants



STORAGE AT THE HEART OF COLLABORATIVE SPACES

CAMILLE 2 accompanies new ways of working by providing a simple, practical and secure storage solution. As an additional feature, the open quarter-circle module holds shared resources and brings a touch of personalisation to the layout. Thanks to its different modules, the range helps organise workspaces and improve user comfort.

CAMILLE 2 lockers
ROBIN desks
OSCAR 2 office chairs
SOLANGE desktop screens



SECURE STORAGE

- › A locking system suited to every use: key, combination lock or RFID, depending on the company's needs and protocols.
- › The RFID lock provides quick, secure access via the supplied RFID badge or a personal code. Its intuitive locking system is smoother and more immediate to use than a traditional mechanical lock, while delivering a reliable solution suited to shared workspaces.

MODULARITY FOR EVERY USE

- › One-piece lockers with 4 to 12 compartments, suited to every space and every use.
- › Open quarter-circle modules providing additional display storage space.
- › A practical adjoining wardrobe rail for hanging coats, jackets and other personal items.
- › An independent cushioned bench unit with integrated storage, creating a convenient space for waiting or rest.



STYLE & DESIGN

- › 25 mm overlay doors cover the structure across its full height, creating a smooth, refined and modern front.
- › The plinth integrated into the body extends the unit naturally down to the floor and ensures a neat finish.
- › CAMILLE 2 has an elegant, structuring design created to enhance shared spaces.

SPACE PLANNING & AREA DIVISION

- › In its PET-upholstered back version, CAMILLE 2 provides effective visual and acoustic separation between work zones.
- › The modules help define different areas, without the need for partitioning.
- › Positioned back to back, low modules can create an informal island accessible from both sides.



SUSTAINABILITY

- › Doors, shelves and plinths made from melamine offcuts from production.
- › Bench cushions available in recycled fabrics.
- › PET panels made from recycled materials.
- › PEFC wood from sustainably managed forests.



Store

Each employee has a secure, adapted personal storage space.



Welcome

In reception areas, CAMILLE 2 creates a structured, refined storage wall. It greets visitors and employees with a clear, practical and secure point of arrival in your workspace.



Divide spaces

With its acoustic PET-upholstered back, CAMILLE 2 defines work zones while preserving the openness of spaces.



Informal island

Back-to-back, low modules create a natural meeting point at the heart of the workspace.



Agile

Create an organised environment where every employee can put away their belongings, settle in and focus.



 **Zooms and/or options**

› **Quarter-circle module**

Ideally positioned at the end of a configuration to provide additional storage.



Mail slot

Allows mail to be delivered without opening the door.



Wardrobe rail

Capacity of up to 20 coat hangers.

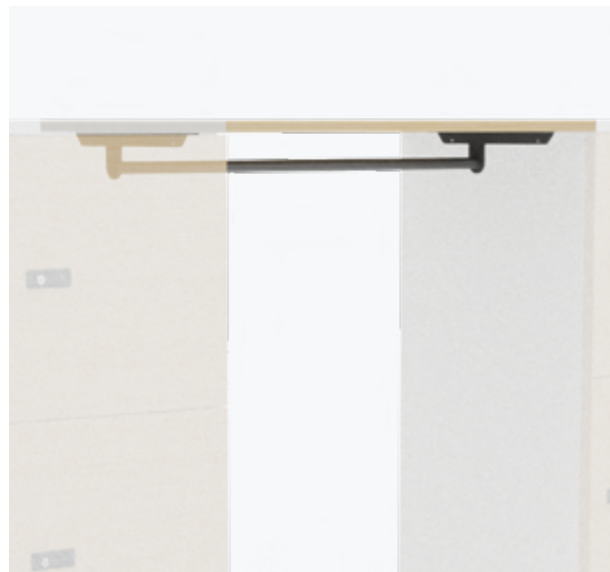

Card holder

Makes it easy to identify personal lockers.



Bench

With internal storage space.



Upholstered back

Provides an aesthetic finishing touch to the rear of the locker and contributes to acoustic comfort.



 **Zooms and/or options**

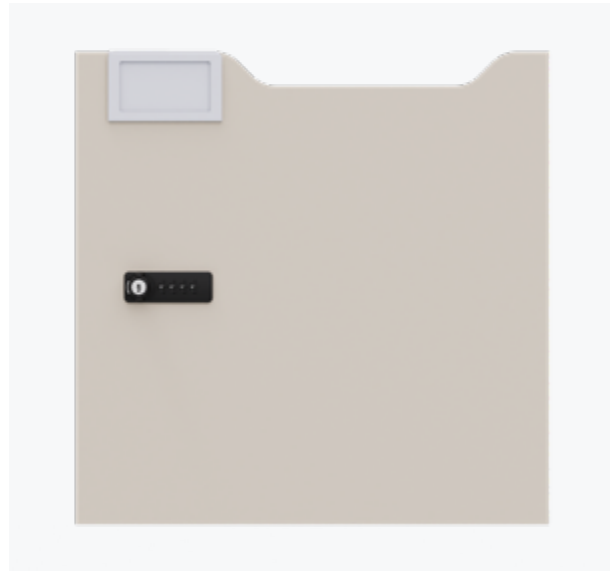

◀ **Door with mail slot + card holder**
With a functional and attractive cut-out.



◀ **RFID lock**
Electronic locking with two opening/closing modes:
by code via the keypad or using the supplied RFID badge.

▶ **Overlay doors**
A smooth, attractive front



▶ **Combination lock**
Manual locking, ideal for non-assigned lockers.

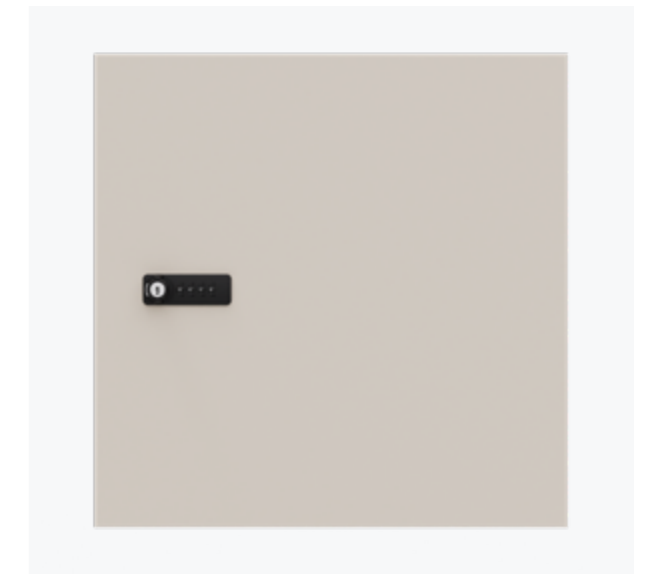

◀ **Base with integrated plinth**
A neat finish right down to the floor.



◀ **Key lock**
Manual locking, ideal for assigned lockers.

Camille 2

TECHNICAL CHARACTERISTICS



EUROPEAN
OFFICE
FURNITURE
MANUFACTURER



Technical characteristics



- › Panels sourced from sustainably managed forests - PEFC
- › Fire rating M3 (moderately flammable) in accordance with standard NF EN 13501-1
- › E05-certified panels (formaldehyde emissions control) with a maximum of 0.062 mg/m³ or a limit of 0.05 ppm and compliant with standard NF EN 717
- › Melamine panels compliant with ISO22196, giving them antibacterial properties
- › 68% on average from recycled materials (pre- and post-consumer) (90% for the R3 finish, Cradle to Cradle certified).
- › 100% recyclable

Secure storage

Available with three lock types: key, code or RFID

Multiple uses

Its various configurations and modules help plan your spaces and meet a range of needs

Locker units



Standard melamine

- › Melamine-covered particleboard panels, thk 19 mm, both sides with an anti-reflective decorative finish
- › Panel density: 620 to 690 kg/m³
- › Flat ABS edging, glued, thk 1 mm, with rounded edges.
- › Edge banding matched to the worktop finish

Compartments

- › Useful dimensions, 1 compartment: W. 378-397* x H. 390 x D. 450 mm
 - Suitable for a motorcycle helmet, a standard keyboard up to 45 cm or laptop up to 17 inches
- › Useful dimensions, 2 compartments: W. 378-397* x H. 800 x D. 450 mm
 - Suitable for a cabin suitcase
 - Option to remove the shelf or leave it in place to divide the compartment into 2 (except central shelves: see specific details on the following pages in the doors section)
- › Melamine divider shelves, thk 25 mm (matching the unit body)
- › Max. evenly distributed load supported per shelf: 20 kg
 - To be dismantled depending on 1- or 2-compartment configuration - supplied assembled
- › Melamine unit with 4, 6, 8, 9 or 12 compartments, supplied assembled
- › 4 metal feet made from 40 x 40 mm section tubes, thk 2 mm, adjustment range 10 mm

* W. 378 mm for the left-hand compartments; W. 396 mm for the central and right-hand compartments (see schematic).

Front plinth

- › H. 80 mm plinth integrated into the base of - melamine plinths, thk 25 mm

Assembly

- › Unit body supplied assembled



Unique EOL design

Conceived by our Design Studio and manufactured in our factory in Normandy

Personal and shared storage

Generous dimensions suited to both everyday personal belongings and professional equipment

Clean aesthetic

Its overlay doors and integrated plinth enhance your spaces

Overlay melamine doors



Standard melamine

- › Melamine-covered particleboard panels, thk 25 mm, both sides with an anti-reflective decorative finish
 - › Panel density: 600 to 670 kg/m³
 - › Flat ABS edging, glued, thk 1 mm
 - › Edging matched to the panel finish
- Black R9 finish: MDF panels (density 695 kg/m³) covered with melamine and a PerfectSense lacquer coating on one side (multiple layers of transparent lacquer), with a matt appearance and silky feel, featuring anti-fingerprint properties.
- › Format :
 - For 1 compartment: H. 412 x W. 412 mm
 - For 2 compartments: H. 827 x W. 412 mm
 - With mail slot: asymmetrical cut-out allowing mail to be inserted without opening the door
 - › Opening / Closing:
 - Right-hand door opening (hinges)
 - Soft-closing hinges
 - Door opening angle: 90° (does not obstruct opening of the next compartment)
 - End stop to be fitted
- › Specific feature of 2-compartment doors: can only be positioned on the 2 upper or lower compartments (because the central shelves cannot be removed)
On 6- and 9-compartment units: can only be positioned at the bottom

Compatibility of 2-compartment doors

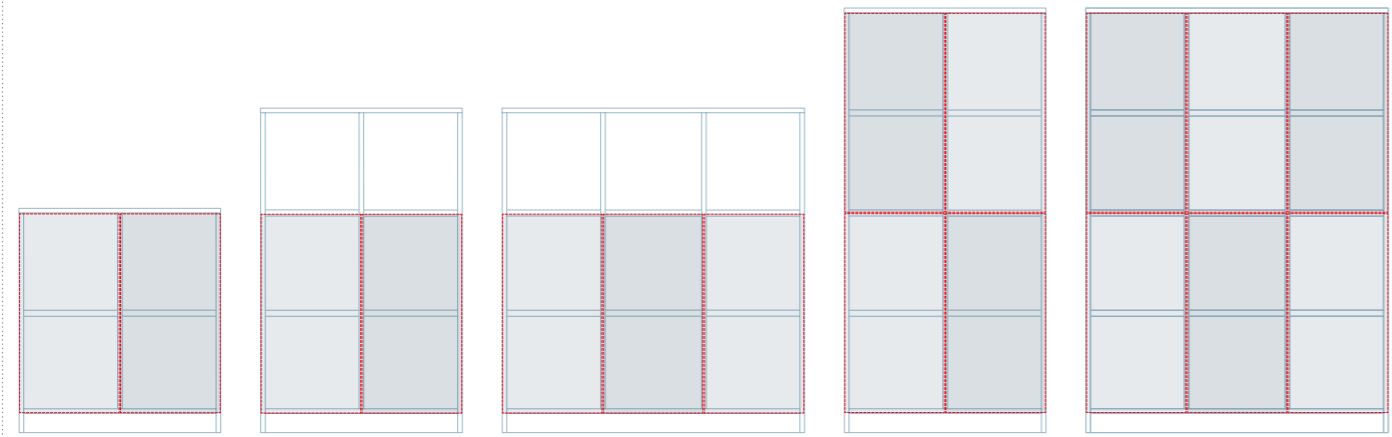

Key lock

- › Body and front cover in polymer
- › Horizontal 1-point cam lock
 - 90° rotation closing
 - Ergonomic rotary knob
- › 2 keys supplied, including 1 folding key
- › A master key enabling all compartments to be opened is available as an option (to be assigned to the office manager)

Assembly

- › Lock to be fitted to the door (screws included)
- › 2 cam lengths: long for centre and right-hand compartments, short for left-hand compartments.

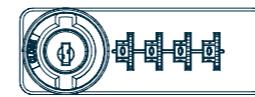

Code lock

- › Body and front cover in polymer
- › Horizontal cam lock
 - 4-digit combination
 - 90° rotation closing
 - Ergonomic rotary knob
- › Dimensions: W. 77 x H. 27 x D. 253 mm

Operation and settings

- › 2 operating modes: private or public (default)
 - Settings are made with the door open
 - The device for switching from public to private mode (or vice versa) is positioned on the rear of the lock (see user manual)
- › 3 indicators: open (green), closed (red), code change (blue)
- › A master key enabling all compartments to be unlocked is available (optional)

Assembly

- › Lock to be fitted to the door (screws included)
- › 2 cam lengths: long for centre and right-hand compartments, short for left-hand compartments.



RFID lock

- › 10-digit front keypad
- › Electronic lock powered by 4 x AA batteries supplied
- › Battery life: 10,000 cycles

Operation and settings

- › 2 operating modes: private or public (default)
 - The device for switching from public to private mode (or vice versa) is positioned on the rear of the lock (see user manual)
- › 1 user badge and 1 emergency opening kit are supplied
- › Opening / closing: using the user badge supplied or a 4- to 8-digit combination via the keypad.
- › 2-year guarantee

Assembly

- › Lock to be fitted to the door (screws included)
- › 2 different drilling patterns depending on the compartment position: see assembly instructions.

Options

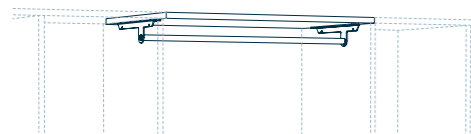

Intermediary wardrobe coat rail

- › Melamine-covered particleboard panels, thk 25 mm, both sides with an anti-reflective decorative finish
- › Panel density: 600 to 670 kg/m³
- › Flat ABS edging, glued, thk 1 mm
- › Dimensions: W. 794 x D. 496 mm
- › Capacity: Up to 20 hangers
- › Black metal rail, dia. 20 mm, thk 2 mm

Assembly

- › Module to be installed between 2 adjacent units - Supplied flat-packed (screws included). We recommend installation between 8- and/or 12-compartment modules for greater ease of use.

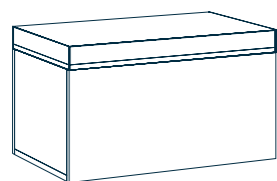

Bench module

- › Melamine-covered particleboard panels, thk 19 mm, both sides with an anti-reflective decorative finish
- › Panel density: 620 to 690 kg/m³
- › Flat ABS edging, glued, thk 1 mm
- › Dimensions: W. 793 x D. 470 x H. 456 mm
- › Foam seat, thk 60 mm, density 43 kg/m³
- › Internal storage available by removing the cushion
- › Maximum load capacity: 160 kg evenly distributed

Assembly

- › Module to be assembled



PET acoustic back panel

- › Panels made from 100% polyester fibre, thk 12 mm
 - › Fire standards: EN 13501 - Class B S1 d0 - M1
 - › Recyclability: 60% recycled material / 100% recyclable (PET: 60% recycled from consumer waste / 35% recycled from production waste)
 - › Fixed to the back by adhesive bonding
 - › Sound absorption coefficient: 0.25-0.95 MHz (E-A rating) according to NF EN ISO 354 and NF EN ISO 11654 standards (test report available on request).
- 2-year warranty.

Assembly

- › Module supplied assembled (integrated into the back of the locker unit)

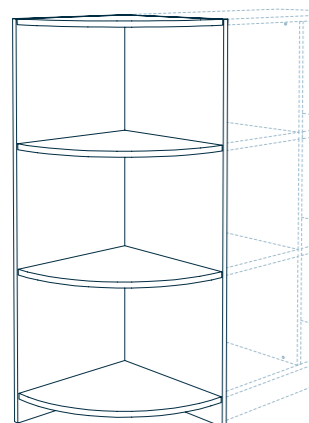

Quarter-circle end modules

- › Melamine-covered particleboard panels, thk 19 mm, both sides with an anti-reflective decorative finish
- › Panel density: 620 to 690 kg/m³
- › Flat ABS edging, glued, thk 1 mm
- › Dimensions: W. 477 mm x D. 496 mm x H. 928 / 1343.5 / 1759 mm
- › Melamine divider shelves, thk 19 mm (matching the unit body)

Assembly

- › Module to be assembled.

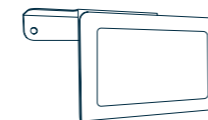

Card holder

- › 0.7 mm sheet steel
- › W. 125 x D. 29 x H. 62 mm
- › Stop for holding the card: recommended card size W. 85 x H. 54 mm (window W. 79 x H. 44 mm)
- Template link : <https://download.eollibrary.net/catalogue/eol25/fr/gabarit-85x54-carte-porte-etiquette-camille.doc>
- › Compatible with all doors
- › Fits onto the top edge of the door - Can be fixed to the back of the door with a screw (wood screw supplied).
- › Available metal finishes: White (SO), Black (SG), Reseda green (ZG)

Master key

- › For code and key locks (different models), enabling all compartments to be opened. To be assigned to the person(s) responsible for locker management.

Locker units

Height 928 mm

① Without PET back panel
② With PET back panel
— removable shelf

4 compartments

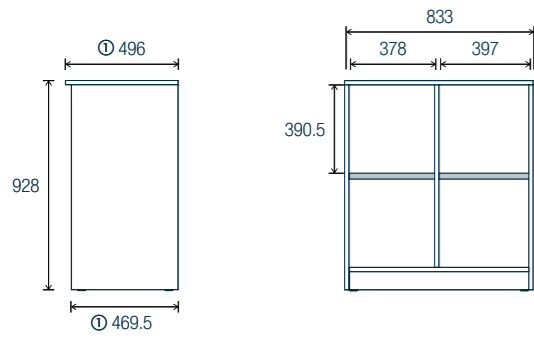

2-compartment corner

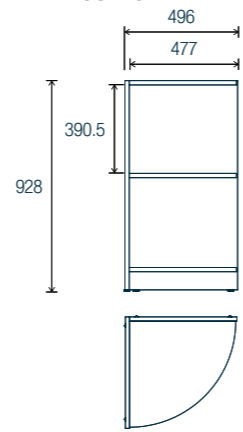

Height 1343.5 mm

6 compartments

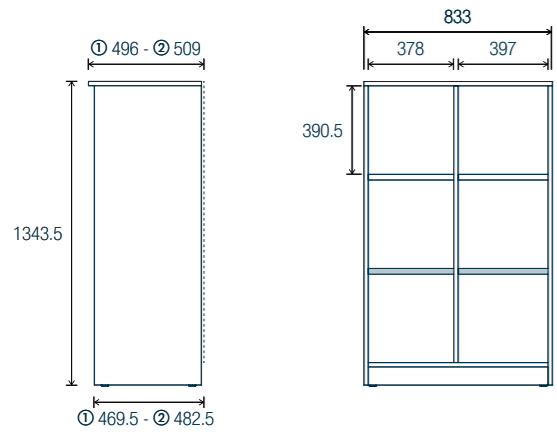

9 compartments

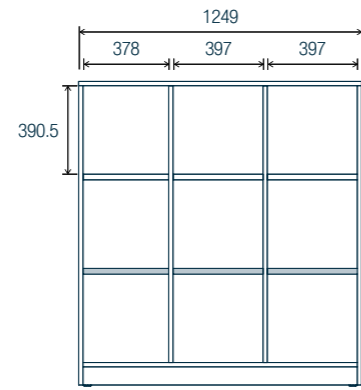

3-compartment corner

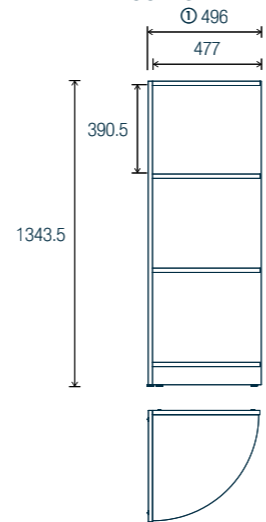

Height 1759 mm

8 compartments

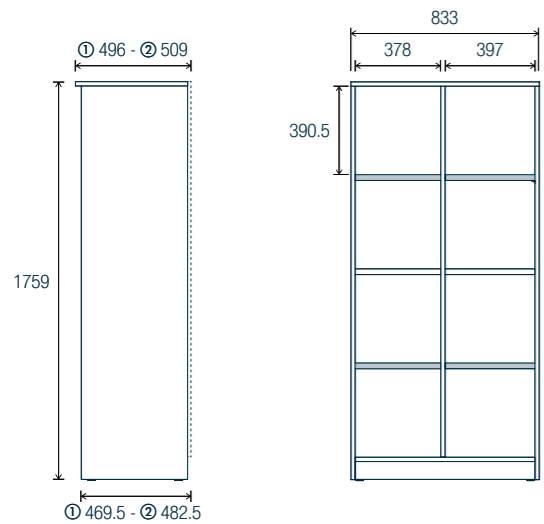

12 compartments

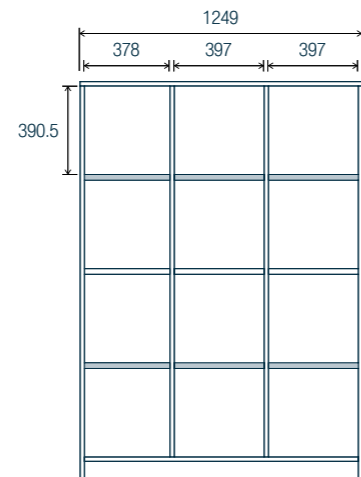

4-compartment corner

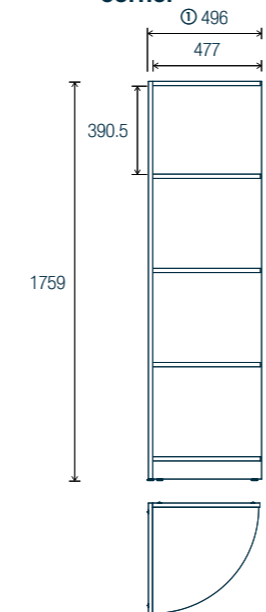

Melamine doors - Key, code or RFID lock

Without mail slot

For 1 compartment

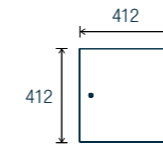

For 2 compartments

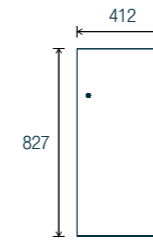

With mail slot

For 1 compartment

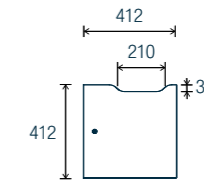

For 2 compartments

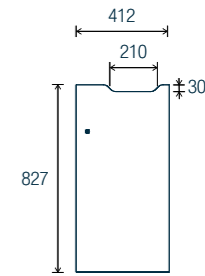

See 2-compartment door compatibility on page 4 of this technical sheet.

Side-by-side wardrobe module

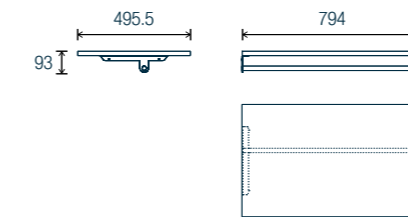

Free-standing bench module

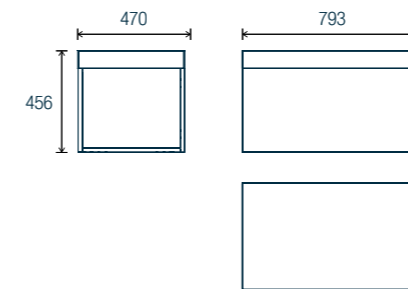

Safety instructions

The furniture in the Camille 2 range (locker units, quarter-circle modules and benches) is designed for use in accordance with the manufacturer's installation and usage instructions. The furniture is designed to be free-standing subject to compliance with the installation conditions, correct adjustment of the levelling feet, compliance with the permissible loads and, depending on the configuration, installation of the recommended or mandatory fixing devices.

To prevent any risk of the furniture tipping over or falling:

For units with a height of 140 cm or less:

› Wall or floor fixing is strongly recommended, particularly in the event of intensive use, uneven flooring, free-standing installation or heavy use of the doors.

For units with a height greater than 140 cm:

› Wall or floor fixing is mandatory

For island layouts or installations in the centre of a room:

› Floor fixing is mandatory for units over 140 cm high

Fixing devices

- › The wall-mounting brackets and floor-fixing kit are supplied with the furniture
- › Screws and wall plugs are not supplied and remain the responsibility of the customer, who must adapt them to the nature of the support (wall, partition, slab, floor, etc.).
- › Wall fixings must be positioned in accordance with the assembly instructions, at the top of the unit.
- › Floor-fixing devices must be installed in accordance with the assembly instructions, at the feet and at the specified points.

Installation conditions

- › The furniture must be installed on a level and stable floor.
- › The levelling feet must be adjusted before the furniture is put into use.

Conditions of use

- › The heaviest loads must be placed in the lower compartments.
- › Any overload at the top is prohibited.
- › The furniture is not designed to support:
 - climbing,
 - a person leaning on it,
 - the suspension of external loads, or any use other than the intended storage use.
- › Doors must be kept closed when not in use.
- › Any modification to the furniture or removal of stabilising/fixing devices is prohibited.

Permissible loads

- › Maximum permissible load per shelf (uniformly distributed load): 20 kg maximum.
- › Total permissible load per module:
 - 4-compartment units: 60 kg maximum
 - 6-compartment units: 90 kg maximum
 - 8-compartment units: 120 kg maximum
 - 9-compartment units: 135 kg maximum
 - 12-compartment units: 180 kg maximum
 - Quarter-circle modules with 2/3/4 compartments: 30/45/60 kg maximum

Installation responsibility

- › The customer is responsible for the compliance and safety of the installation, particularly with regard to:
 - the nature and strength of the supports,
 - the choice of fixing systems,
 - compliance with the manufacturer's assembly instructions
- › Installation on a sloping, uneven or deformable floor is prohibited unless a suitable compensating device is used.

Shade card

Melamine - Shells / Doors

Wood finishes



RZ
Lakeland acacia



R1
Natural oak

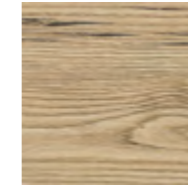

R3
Brunswick oak

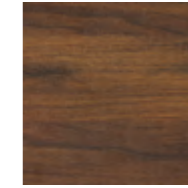

N6
Dark walnut

Plain colours

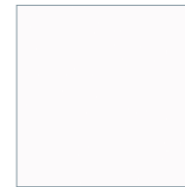

MG
Snow white



N5
Linen



R7*
Avocado green



R9
Black PerfectSense*

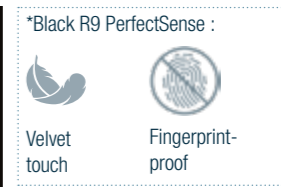

*Black R9 PerfectSense :



Velvet touch



Fingerprint-proof

*R7, R9 Doors only

PET - Acoustic back cladding

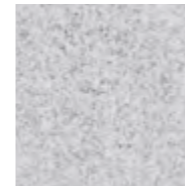

ON
Concrete grey



OP
Petroleum blue

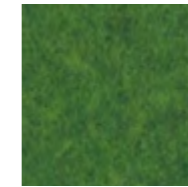

OT
Avocado



OY
Mandarin

Fabrics - Bench

Chili - Cat. B



Step / Step mélange - Cat. B

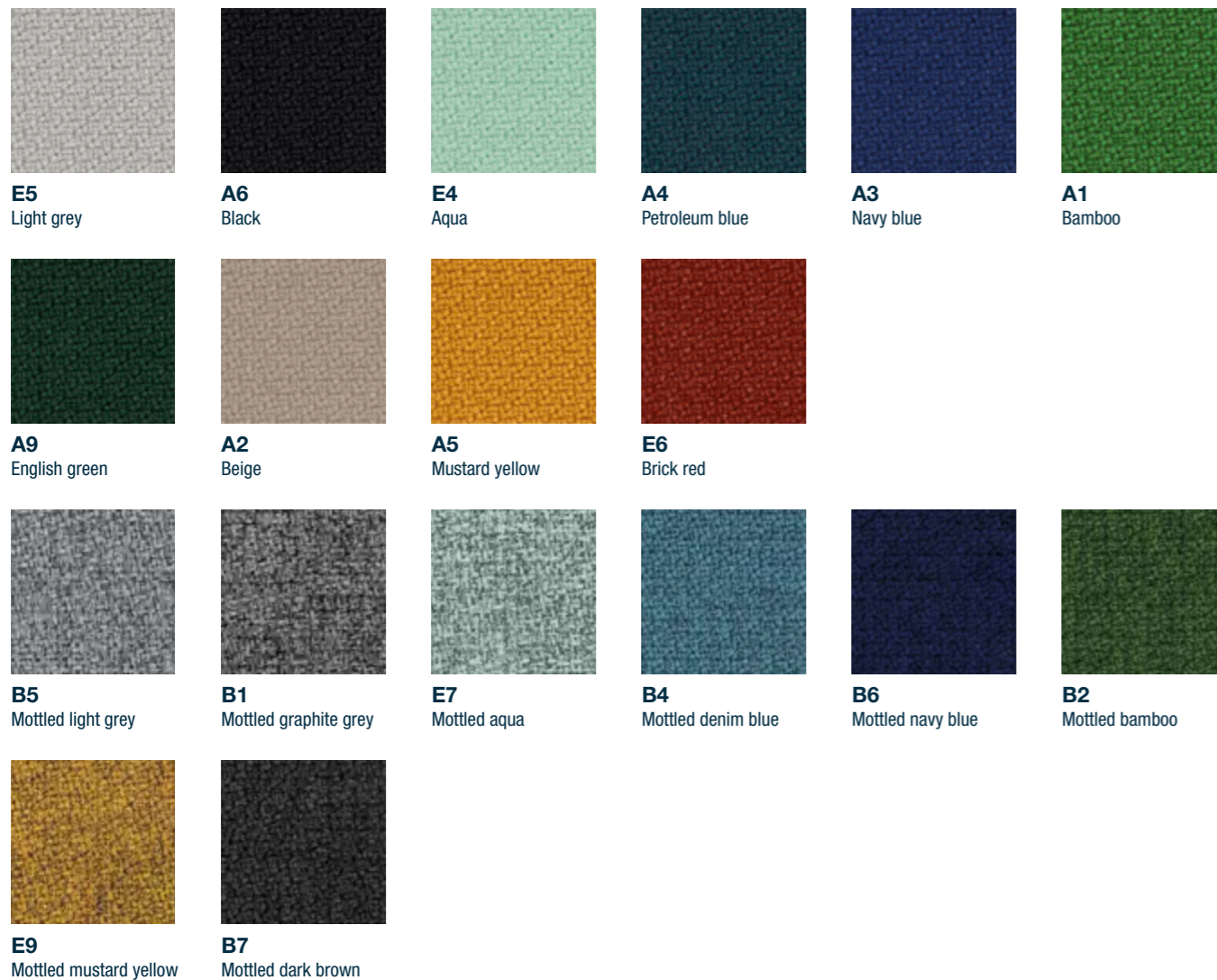

Wood - shell, doors, shelves, plinths

	Melamine	
	Thick 19 mm	Thick 25 mm
	Top, sides, backs	Doors, shelves, plinths
Double-sided anti-reflective coating	✓	✓
Finishes	All	All
Shock-resistant, with rounded edges ⁽¹⁾	✓	✓
Antibacterial	✓	✓
Density ⁽²⁾	620 > 690 kg/m ³	600 > 670 kg/m ³
PEFC (sourced from sustainably managed forests)	✓	✓
E05 certified (compliant with standard NF EN 717)	✓	✓
Fire rating (compliant with standard EN 13501-1)	Rating M3 (EUROCLASS D-S2, d0) for all finishes.	
Average % from recycled materials (pre- and post-consumer)	68%	
% recyclability	100%	
Cleaning	Wipe with a damp cloth and soapy water. Do not use abrasive products or detergents.	

*Black R9 finish : covered with melamine and a PerfectSense lacquer coating on one side
 (1) Edge banding in matching finish to worktops, except for N3 worktops (specific plywood edging) - ABS edge banding thk 2 mm
 (2) Density: Tolerance +/- 10%

Fabrics

Chili - Cat. B

Composition	Weight	Abrasion resistance	Light fastness	Fastness to rubbing	Flammability	Environment
100% flame-retardant post-consumer recycled polyester (FR inside fibres)	470 g/m ² (15.16 oz / lin yd)	60 000 EN ISO 12947-2	5-8 EN ISO 105-B02	4-5 EN ISO 105 x 12 Wet/Dry	EN 1021 - 1&2 NFP 92-503/504/505 M1 NF D 60-013 AM18 BS 7176 BS 5852 Crib 5 DIN 4102 B1 EN 13501	STANDARD 100 by OEKO-TEX® 100% recycled fabric Low emission of VOC

Step / Step Mélange - Cat. B

Composition	Weight	Abrasion resistance	Light fastness	Fastness to rubbing	Flammability	Environment
100% trevira® CS	470 g/m ² (15.16 oz / lin yd)	100 000 EN ISO 12947-2	5-7 EN ISO 105-B02	4-5 EN ISO 105 x 12 Wet/Dry	EN 1021 - 1&2 NFP 92-503/504/505 M1 NF D 60-013 AM18 BS 7176 BS 5852 Crib 5 DIN 4102 B1 EN 13501	STANDARD 100 by OEKO-TEX® EU Ecolabel Non-metallic dyestuffs Low emission of VOC

Made in France



Designed by our Design Studio and manufactured in France,
in our Normandy factories



PEFC is the world's leading forest certification system and largest source
of eco-certified forest products.

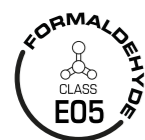

An **E05 rating** corresponds to a maximum of 0.062 mg/m³ or a limit of 0.05 ppm
and comply with **standard NF EN 717-2** and is the most stringent of the ratings authorised
in France for furniture and construction materials



Antibacterial surface. Guaranteed on all melamine worktops



All the components are **guaranteed for 5 years** under normal use (excluding the acoustic PET
cladding and RFID lock, which are guaranteed for 2 years).



77% of this range is made from **recycled materials**
Camille 2.0 is a **fully recyclable** range



EUROPEAN
OFFICE
FURNITURE
MANUFACTURER



PARIS

1 rue des Céréales - Bât 112 - 93200 SAINT DENIS - Tel : +33 (0)1 49 35 60 00

BRUXELLES

81, Chaussée de Nivelles - 1420 BRAINE-L'ALLEUD - Tel : +32 (0)2 894 99 80

eol-group.net



Melamine shell	SMOOTH BACK		ACOUSTIC PET BACK	
	Ref.	Price excl. tax	Ref.	Price excl. tax
To be completed with melamine doors (hinges on the right) - Useful dimensions, 1 compartment: W. 37.8-39.7 x H. 39 x D. 45 cm Front plinth integrated into the unit body. Unit delivered fully assembled Available with a smooth back or with acoustic PET back upholstered back panels				

H. 92.8 CM				
	4-compartment unit - W. 83.3 cm	1 067 868 + #1	£ 507	-

H. 134.4 CM				
	6-compartment unit - W. 83.3 cm	1 067 869 + #1	£ 694	1 067 893 + #1 #2
	9-compartment unit - W. 124.9 cm	1 067 871 + #1	£ 895	1 067 895 + #1 #2

H. 175.9 CM				
	8-compartment unit - W. 83.3 cm	1 067 870 + #1	£ 797	1 067 894 + #1 #2
	12-compartment unit - W. 124.9 cm	1 067 872 + #1	£ 1 082	1 067 896 + #1 #2

Melamine doors	KEY-OPERATED LOCK		COMBINATION LOCK		RFID LOCK	
	Ref.	Price excl. tax	Ref.	Price excl. tax	Ref.	Price excl. tax
	Door for 1 compartment					
	Without mail slot - per unit					
	Door for 2 compartments					
	Without mail slot - per unit					

	1 067 874 + #1	£ 89	1 067 878 + #1	£ 89	1 067 908 + #1	£ 167
	1 067 873 + #1	£ 89	1 067 877 + #1	£ 89	1 067 907 + #1	£ 167
	1 067 876 + #1	£ 108	1 067 880 + #1	£ 108	1 067 909 + #1	£ 187
	1 067 875 + #1	£ 108	1 067 879 + #1	£ 108	1 067 910 + #1	£ 187

Options		Ref.	Price excl. tax
	Set of 4 metal card holders - To be placed on top of the door (wood screw supplied for fixing) – Card size: 85 x 54 mm (cards not supplied) H. 62 x W. 125 x 29 mm thick	1 067 892 + #3	£ 47
	Master key For combination lock	1 067 814	£ 10
	For key-operated lock	1 067 911	£ 10

Additional modules		Ref.	Price excl. tax
--------------------	--	------	-----------------

WARDROBE MODULE			
Wardrobe hanging rail module must be installed BETWEEN two locker units, preferably H. 175.9 cm - black-finish wardrobe rail			
	W. 79.4 x D. 49.6 cm	1 067 901 + #1	£ 108

INDEPENDENT BENCH SEAT			
Module with seat cushion			
	W. 79.3 x D. 47 x H. 45.6 cm	1 067 902 + #1 #4	£ 354

QUARTER-CIRCLE END MODULES			
Plinth base built into the unit - Melamine structure			
	H. 92.8 cm - 2 compartment - W. 47.7 x D. 49.6 cm	1 067 885 + #1	£ 246
	H. 134.4 cm - 3 compartment - W. 47.7 x D. 49.6 cm	1 067 886 + #1	£ 305
	H. 175.9 cm - 4 compartment - W. 47.7 x D. 49.6 cm	1 067 887 + #1	£ 359



MELAMINE		PET				METAL			FABRIC - Cat. B	
#1 Shell / Doors / Shelves	#2 Back panel	#3 Card holders	#4 Cushion pad							
<div style="display: flex; justify-content: space-between;"> <div>MG</div> <div>N5</div> <div>R7*</div> <div>R9*</div> <div>RZ</div> <div>R1</div> <div>R3</div> <div>N6</div> </div>	<div style="display: flex; justify-content: space-between;"> <div>ON Concrete grey</div> <div>OP Petroleum blue</div> <div>OT Avocado</div> <div>OY Mandarin</div> </div>	<div style="display: flex; justify-content: space-between;"> <div>SO</div> <div>SG</div> <div>ZG</div> </div>	<div style="display: flex; justify-content: space-between;"> <div>B5</div> <div></div> </div>							
								Chili - Step / Step mélange		



* R7 and R9 finishes available for doors only



Melamine shell	SMOOTH BACK		ACOUSTIC PET BACK	
	Ref.	Price excl. tax	Ref.	Price excl. tax
To be completed with melamine doors (hinges on the right) - Useful dimensions, 1 compartment: W. 37.8-39.7 x H. 39 x D. 45 cm Front plinth integrated into the unit body. Unit delivered fully assembled Available with a smooth back or with acoustic PET back upholstered back panels				

H. 92.8 CM				
	4-compartment unit - W. 83.3 cm	1 067 868 + #1	€ 577	-

H. 134.4 CM				
	6-compartment unit - W. 83.3 cm	1 067 869 + #1	€ 790	1 067 893 + #1 #2 € 1 266
	9-compartment unit - W. 124.9 cm	1 067 871 + #1	€ 1 019	1 067 895 + #1 #2 € 1 495

H. 175.9 CM				
	8-compartment unit - W. 83.3 cm	1 067 870 + #1	€ 907	1 067 894 + #1 #2 € 1 523
	12-compartment unit - W. 124.9 cm	1 067 872 + #1	€ 1 232	1 067 896 + #1 #2 € 1 848

Melamine doors	KEY-OPERATED LOCK		COMBINATION LOCK		RFID LOCK	
	Ref.	Price excl. tax	Ref.	Price excl. tax	Ref.	Price excl. tax
	Door for 1 compartment					
	Without mail slot - per unit					
	Door for 2 compartments					
	Without mail slot - per unit					

	①		
			RFID badge + emergency opening kit included

Options		Ref.	Price excl. tax
	Set of 4 metal card holders - To be placed on top of the door (wood screw supplied for fixing) – Card size: 85 x 54 mm (cards not supplied)	1 067 892 + #3	€ 54
	Master key		
	For combination lock	1 067 814	€ 11
	For key-operated lock	1 067 911	€ 11

Additional modules		Ref.	Price excl. tax
--------------------	--	------	-----------------

WARDROBE MODULE			
Wardrobe hanging rail module must be installed BETWEEN two locker units, preferably H. 175.9 cm - black-finish wardrobe rail			
	W. 79.4 x D. 49.6 cm	1 067 901 + #1	€ 123

INDEPENDENT BENCH SEAT			
Module with seat cushion			
	W. 79.3 x D. 47 x H. 45.6 cm	1 067 902 + #1 #4	€ 403

QUARTER-CIRCLE END MODULES			
Plinth base built into the unit - Melamine structure			
	H. 92.8 cm - 2 compartment - W. 47.7 x D. 49.6 cm	1 067 885 + #1	€ 280
	H. 134.4 cm - 3 compartment - W. 47.7 x D. 49.6 cm	1 067 886 + #1	€ 347
	H. 175.9 cm - 4 compartment - W. 47.7 x D. 49.6 cm	1 067 887 + #1	€ 409

MELAMINE		PET				METAL			FABRIC - Cat. B	
#1 Shell / Doors / Shelves	#2 Back panel	#3 Card holders	#4 Cushion pad							
<div style="display: flex; justify-content: space-between;"> <div style="background-color: #cccccc; padding: 2px;">MG</div> <div style="background-color: #d9d9d9; padding: 2px;">N5</div> <div style="background-color: #a6a6a6; padding: 2px;">R7*</div> <div style="background-color: #808080; padding: 2px;">R9*</div> <div style="background-color: #606060; padding: 2px;">RZ</div> <div style="background-color: #404040; padding: 2px;">R1</div> <div style="background-color: #202020; padding: 2px;">R3</div> <div style="background-color: #000000; padding: 2px;">N6</div> </div>	<div style="display: flex; justify-content: space-between;"> <div style="background-color: #cccccc; padding: 2px;">ON Concrete grey</div> <div style="background-color: #000080; padding: 2px;">OP Petroleum blue</div> <div style="background-color: #008000; padding: 2px;">OT Avocado</div> <div style="background-color: #ff8c00; padding: 2px;">OY Mandarin</div> </div>	<div style="display: flex; justify-content: space-between;"> <div style="background-color: #cccccc; padding: 2px;">SO</div> <div style="background-color: #000000; padding: 2px;">SG</div> <div style="background-color: #008000; padding: 2px;">ZG</div> </div>	<div style="background-color: #cccccc; padding: 2px;">B5</div>	Chili - Step / Step mélange						

* R7 and R9 finishes available for doors only